



Friends™



41304



LEGO.com/friends



WARNING: CHOKING HAZARD.
Small parts. Not for children under 3 years.

 **AVERTISSEMENT : RISQUE D'ÉTOUFFEMENT.**
Contient des petites pièces. Ne convient pas aux enfants de moins de 3 ans.

 **ADVERTENCIA: PELIGRO DE ASFIXIA.**
No recomendado para niños menores de 3 años.
Contiene piezas pequeñas.



1

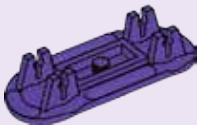

2

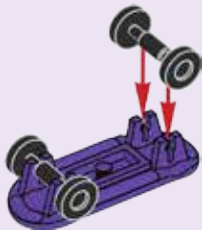

3





1

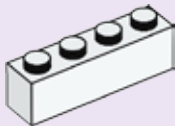

4

2

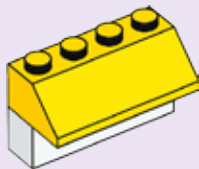

3

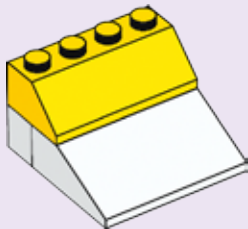

4

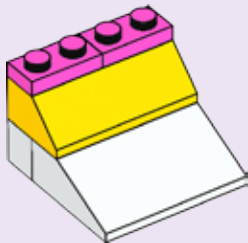

5

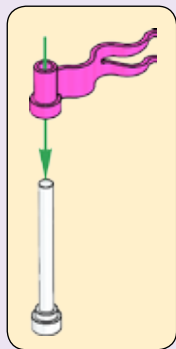
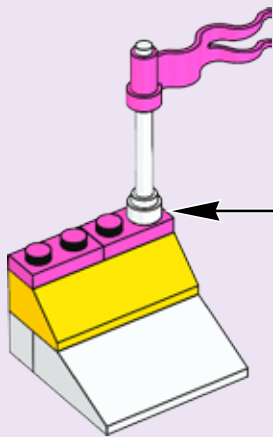



1

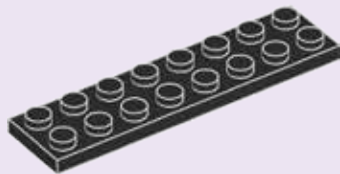

2

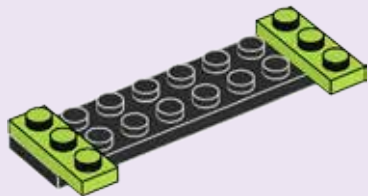

3

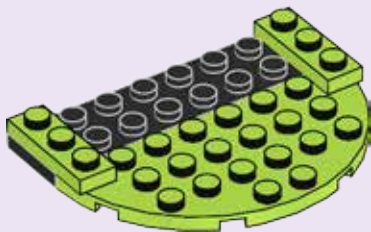

4

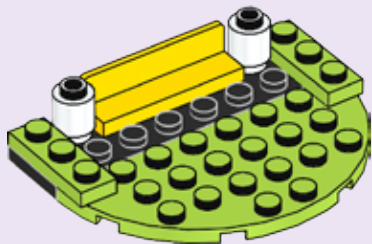

5

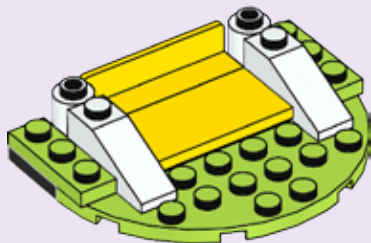

6

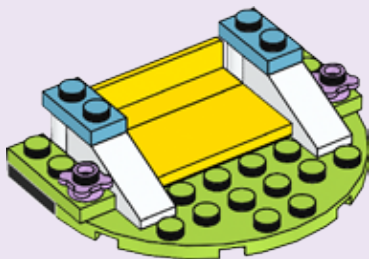

7

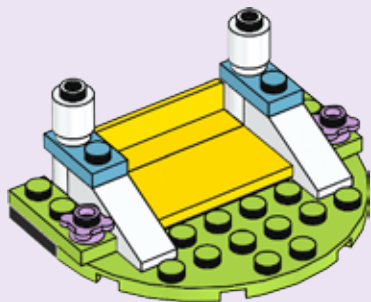

8

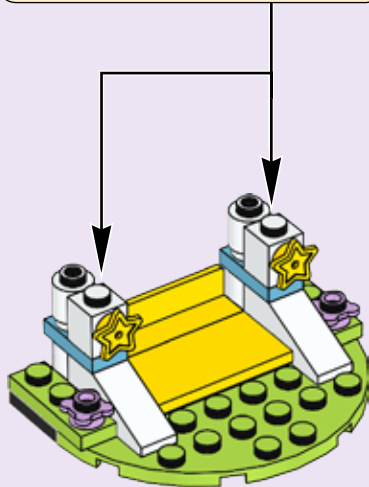

9

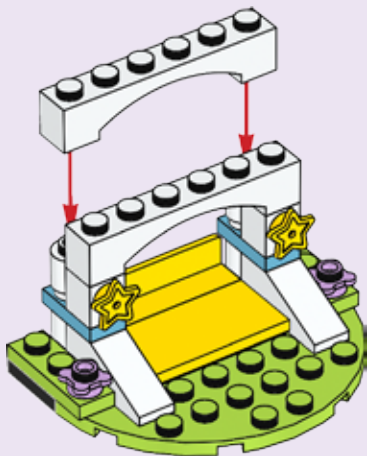

10

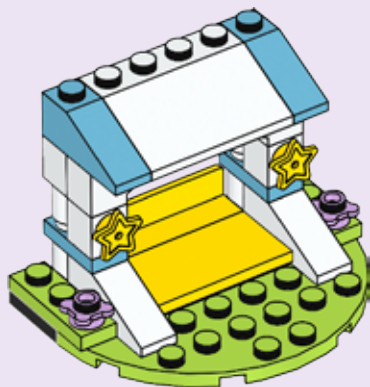

11

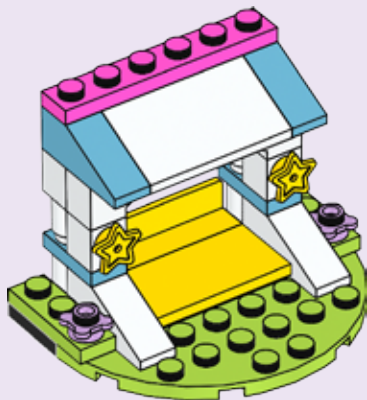

12

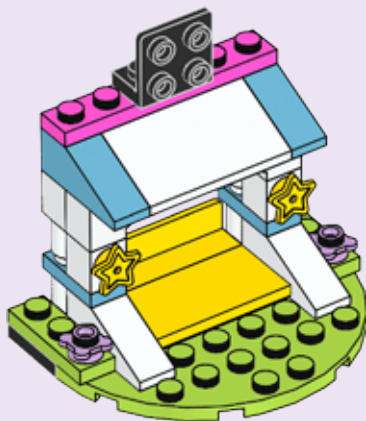

13

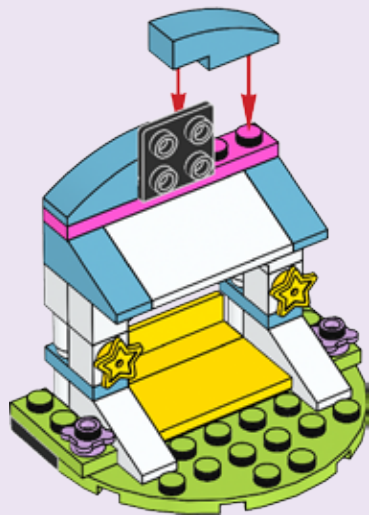

16

14

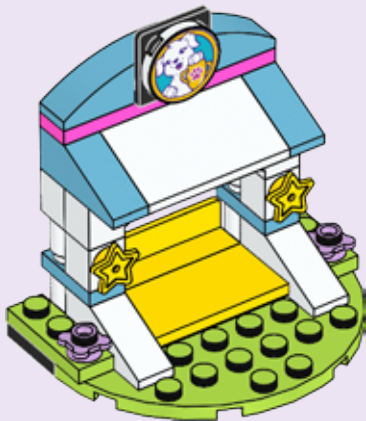

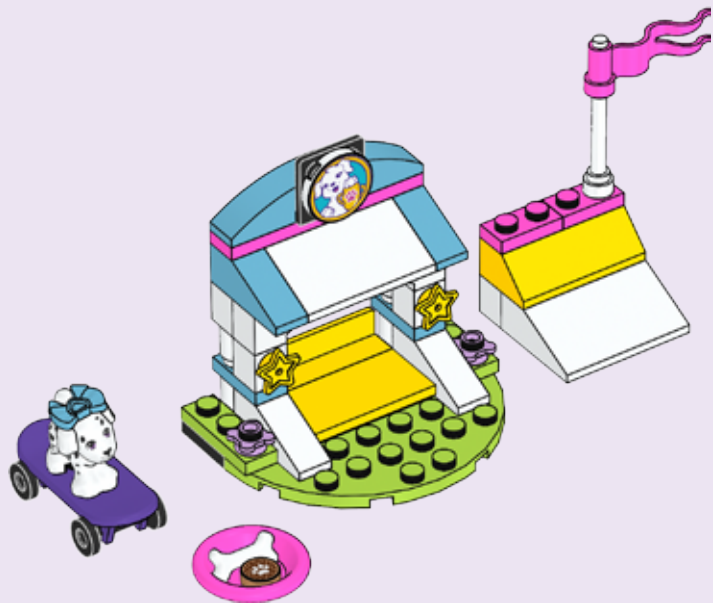



4x
306201



2x
428601



1x
4219911



1x
6133225



1x
6097094



2x
6097419



2x
4558952



1x
6174237



1x
4560181



2x
6057387



1x
6152676



2x
6097317



1x
4600294



1x
301001



2x
249626



1x
4243677



1x
6023825



2x
6035598



1x
6113032



1x
395701



1x
6000650



1x
6173002



1x
6023825



2x
6035598



2x
329701



1x
6174272



1x
303426



1x
6173002



1x
6023825



2x
6035598



2x
6184648



2x
4620761



1x
6092648



2x
4210210



Customer Service

Kundenservice

Service Consommateurs

Servicio Al Consumidor

LEGO.com/service or dial



: 00800 5346 5555

: 1-800-422-5346



Friends™



■ 41301



■ 41300



■ 41302



■ 41303



■ 41304

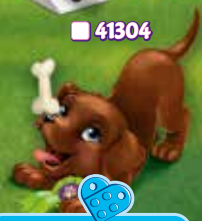

LEGO.com/friends



Friends™





Ask parents' permission first.
Demande d'abord l'autorisation d'un parent.
Pide antes permiso a tus padres.



Friends™



LEGO.com/friends



Apple and the Apple logo are trademarks of Apple Inc., registered in the U.S. and other countries. App Store is a service mark of Apple Inc.

Google Play is a trademark of Google Inc.



Friends™

LEGO.com/friends



Terms & Conditions apply



LEGO.com/productfeedback

GEWINNE



Erzähle uns auf
www.LEGO.com/productfeedback

etwas über die Erfahrungen, die du mit diesem LEGO® Set gemacht hast, und sichere dir die Chance auf einen coolen LEGO Preis!

Es gelten die Teilnahmebedingungen

GAGNE



Rends-toi sur
www.LEGO.com/productfeedback

et donne-nous quelques commentaires sur ce produit LEGO® pour avoir une chance de gagner un prix LEGO !

Voir Conditions Générales

GANA



Visita
www.LEGO.com/productfeedback

y envíanos tu opinión acerca de este set LEGO®. ¡Participarás en el sorteo de un premio LEGO!

Términos y Condiciones aplicables

获取奖品



登录
www.LEGO.com/productfeedback

给出关于此乐高®套装的简短反馈，就有机会获得炫酷乐高奖品

《条款及条件》适用

LEGO, the LEGO logo and the FRIENDS logo are trademarks of the/son des marques de commerce du/son marcas registradas de LEGO Group. ©2017 The LEGO Group.