



BRICK SKETCHES™

40431



Disney

STAR
WARS

BB-8™

Some time ago I was a part of an artists' group on a popular social media platform. Many of the artists were doing marker sketches on small cardstock as a way to engage with their fans. I thought this was a fantastic idea, but I wanted to put my own spin on it using LEGO® bricks. This led to the creation of the very first Brick Sketch. I posted it to my social media channels with some apprehension, not entirely sure how my fans would react. Thankfully, they loved the concept and wanted to see more!

After some experimenting, I nailed down the basics: Brick Sketches would be plate-based artwork that featured a front-facing character on a 12x16 canvas. Given that Brick Sketches are somewhat three-dimensional, it was also important that they have correct relief wherever possible; for example, the character's chin shouldn't extend further out than the nose. The challenge was to use LEGO pieces creatively to build detailed character artwork on a relatively small canvas.

Brick Sketches became far more popular than I ever expected. Fans loved suggesting new characters and often asked me to create instructions so that they could build their favorites. It was difficult to set aside the concept when I started working at the LEGO Group, but through an amazing series of events, Brick Sketches are now available from the LEGO Group itself. It's a dream come true.



LEGO® designer Chris McVeigh

BB-8™

Il y a quelque temps, je faisais partie d'un groupe d'artistes sur la plate-forme d'un média social très connu. De nombreux artistes réalisaient des croquis au marqueur sur de petits cartons pour interagir avec leurs fans. Cette idée me plaisait beaucoup, mais je voulais y apporter ma touche personnelle à l'aide de briques LEGO®. J'ai donc eu l'idée de créer le tout premier croquis en briques. Je l'ai publié sur mes réseaux sociaux avec une certaine appréhension, car je ne savais pas comment mes fans allaient réagir. Heureusement, ils ont adoré le concept et en ont redemandé !

Après quelques expérimentations, je me suis fixé des règles : les croquis en briques devaient être des œuvres montées sur une plaque et ils devaient représenter un personnage de face sur une toile de 12 x 16 tenons. Comme les croquis en briques sont tridimensionnels, il était également important qu'ils soient correctement proportionnés dans la mesure du possible. Le menton du personnage ne devait pas être plus long que le nez, par exemple. Le défi consistait à utiliser des pièces LEGO de manière créative pour construire des représentations détaillées de personnages sur une toile relativement petite.

Les croquis en briques ont eu beaucoup plus de succès que je ne l'aurais imaginé. Les fans adoraient me suggérer de nouveaux personnages et me demandaient souvent de créer des instructions pour pouvoir les construire eux-mêmes. Lorsque j'ai commencé à travailler pour le Groupe LEGO, j'ai eu du mal à mettre ce concept de côté, mais suite à un concours de circonstances incroyable, le Groupe LEGO a fini par proposer lui-même les croquis en briques. Un rêve est devenu réalité.



Le designer LEGO® Chris McVeigh

BB-8™

Hace tiempo, fui miembro de un grupo de artistas en una popular red social. Muchos de ellos hacían dibujos con marcadores en pequeños lienzos de cartulina para interactuar con sus fans. Me pareció una idea fantástica, pero quise darle mi propio toque personal usando bricks LEGO®. Eso fue lo que condujo a la creación del primer Brick Sketch. Lo publiqué en mis canales de las redes sociales con cierta desconfianza, sin estar del todo seguro de cómo reaccionarían mis fans. ¡Afortunadamente, les encantó el concepto y querían ver más!

Luego de experimentar un poco, definí lo básico: un Brick Sketch sería un diseño a base de placas que representaría a un personaje, de frente, sobre un lienzo de 12x16. Dado que los Brick Sketches son, en cierto modo, tridimensionales, también era importante recrear el relieve correcto donde fuera posible; por ejemplo, la barba de un personaje no debía sobresalir más que su nariz. El desafío consistía en usar piezas LEGO con creatividad para construir retratos detallados de personajes sobre un lienzo relativamente pequeño.

Los Brick Sketches acabaron haciéndose mucho más populares de lo que esperaba. A los fans les encantaba sugerir nuevos personajes y, a menudo, me pedían que creara las instrucciones necesarias para construir a sus favoritos. Fue difícil apartarme de la idea cuando empecé a trabajar en The LEGO Group. Sin embargo, luego de una sorprendente serie de acontecimientos, los Brick Sketches vuelven a estar disponibles, ahora oficialmente, como productos LEGO. Es un sueño hecho realidad.



El diseñador de LEGO® Chris McVeigh



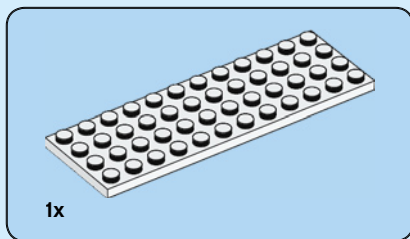

1

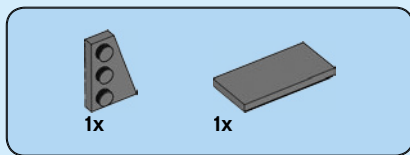
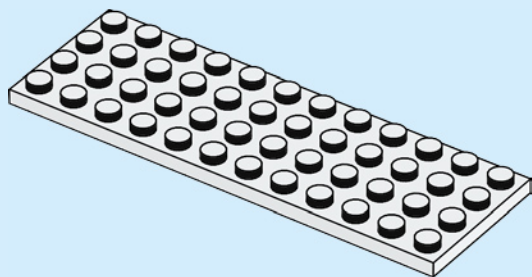

2

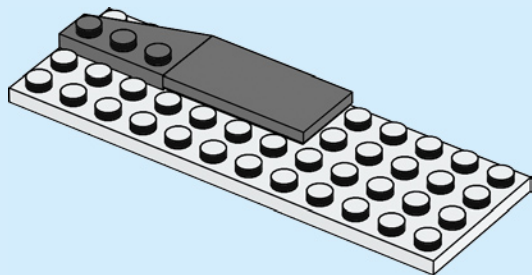

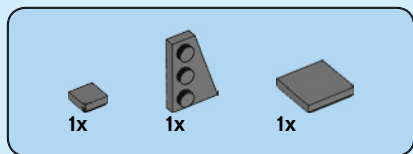

3

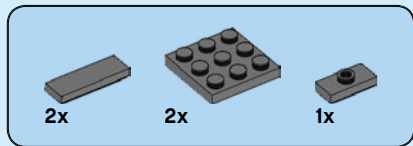
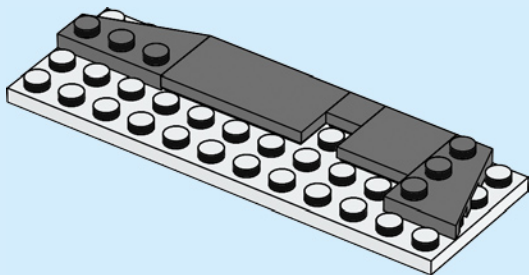

4

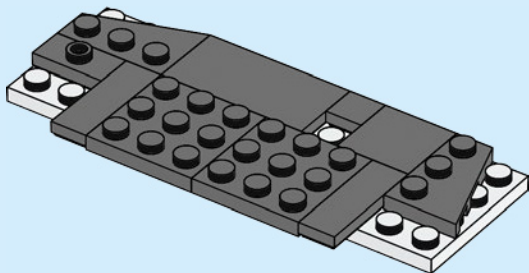

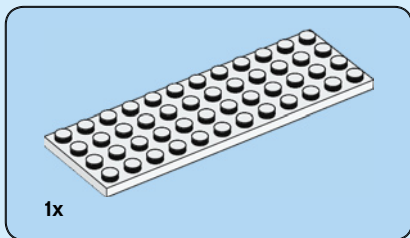

5

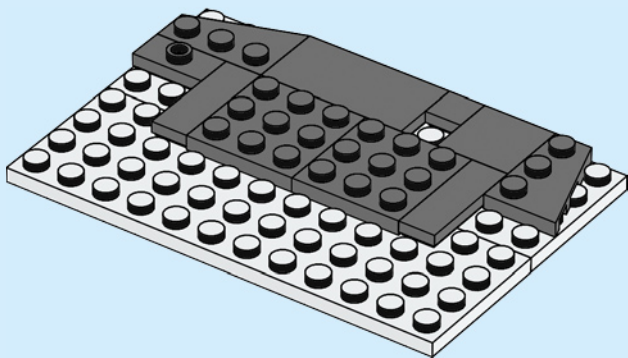

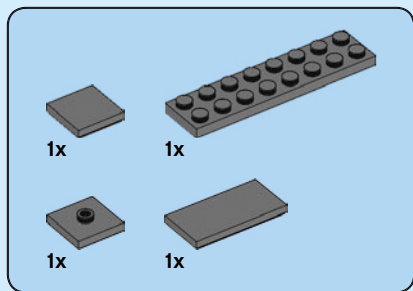

6

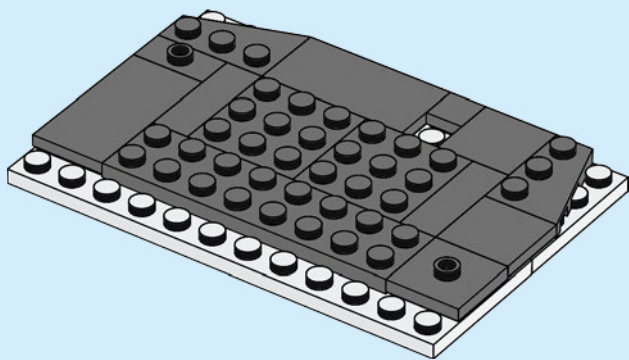

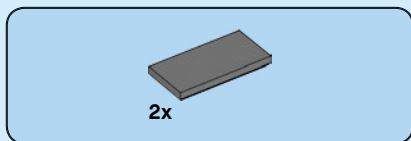

7

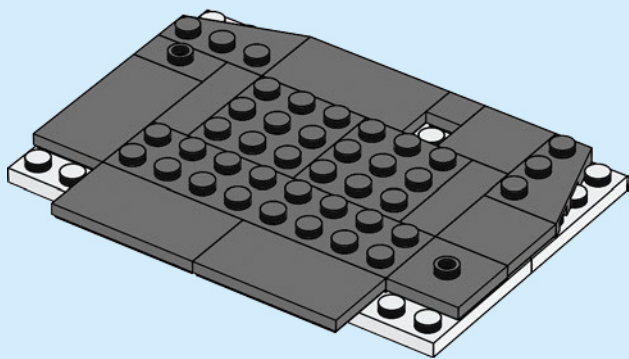

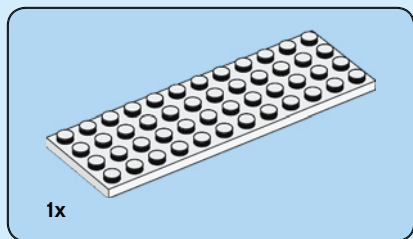

8

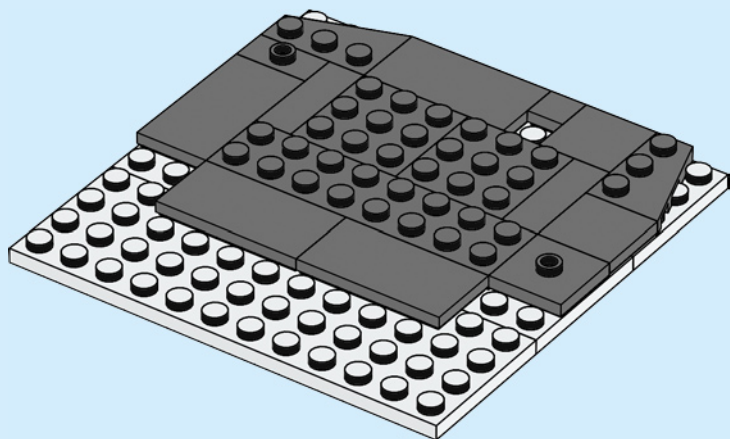

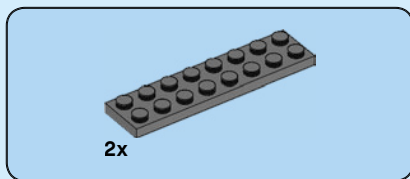

9

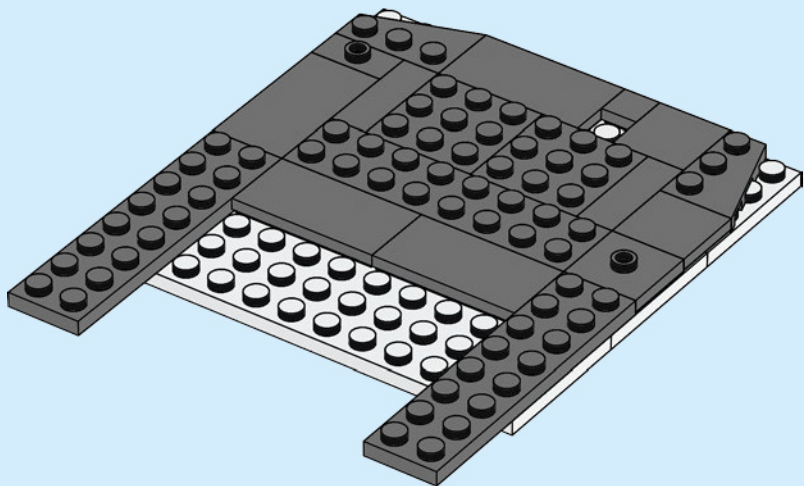

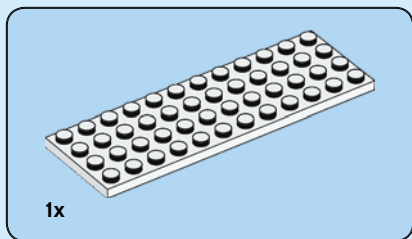

10

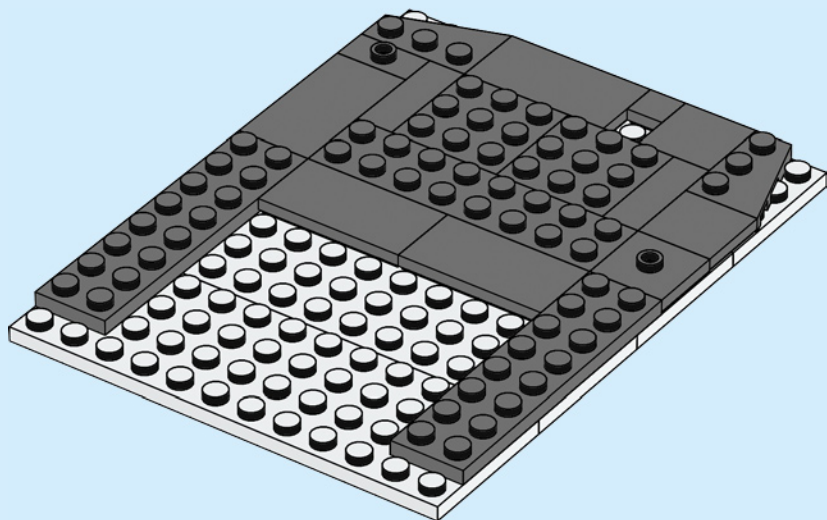



2x

11

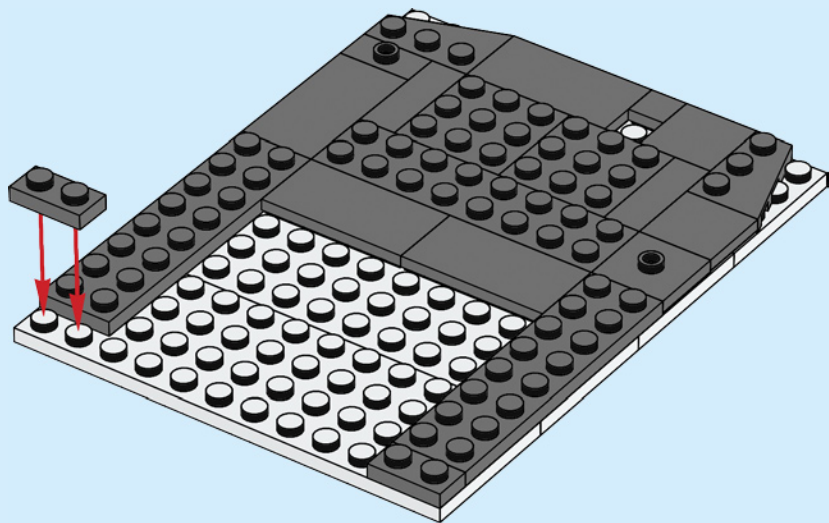

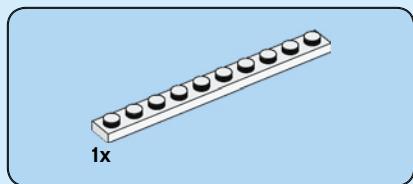

12

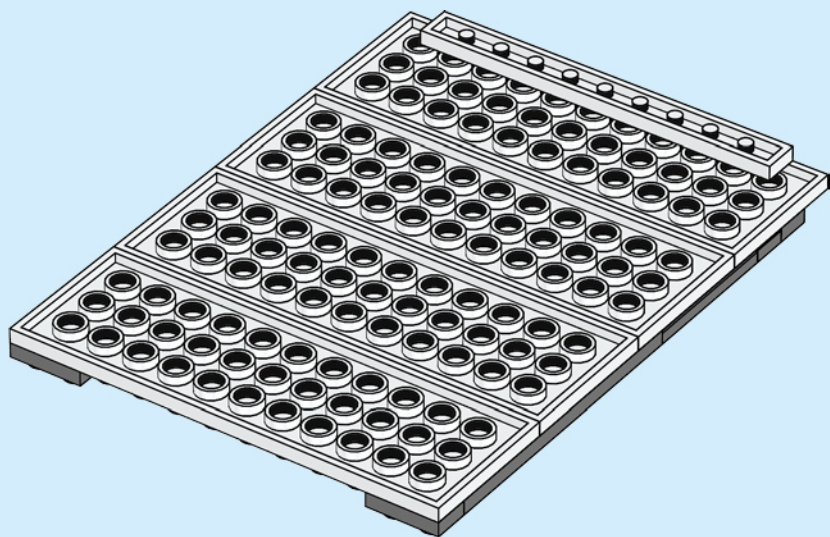



2x



1x

13

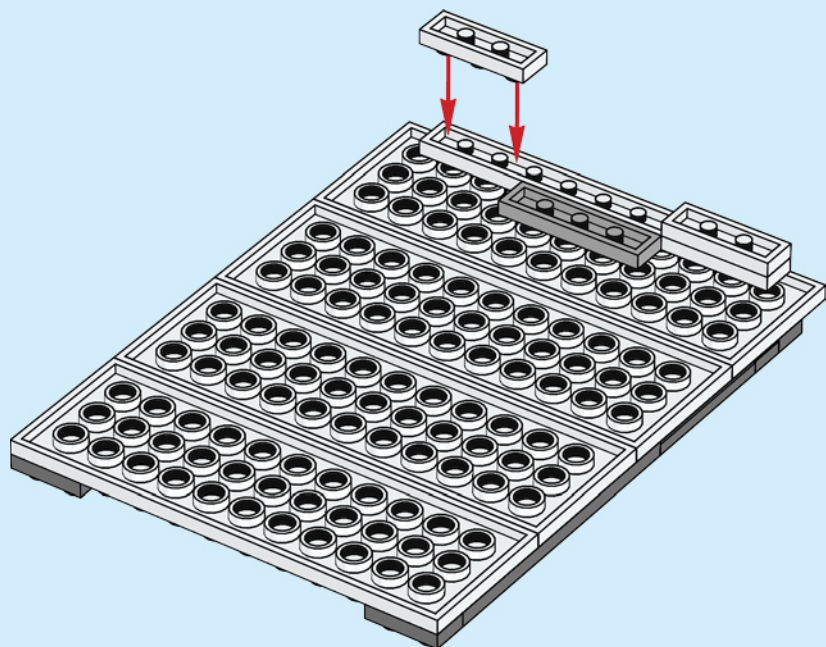



1x



2x

14

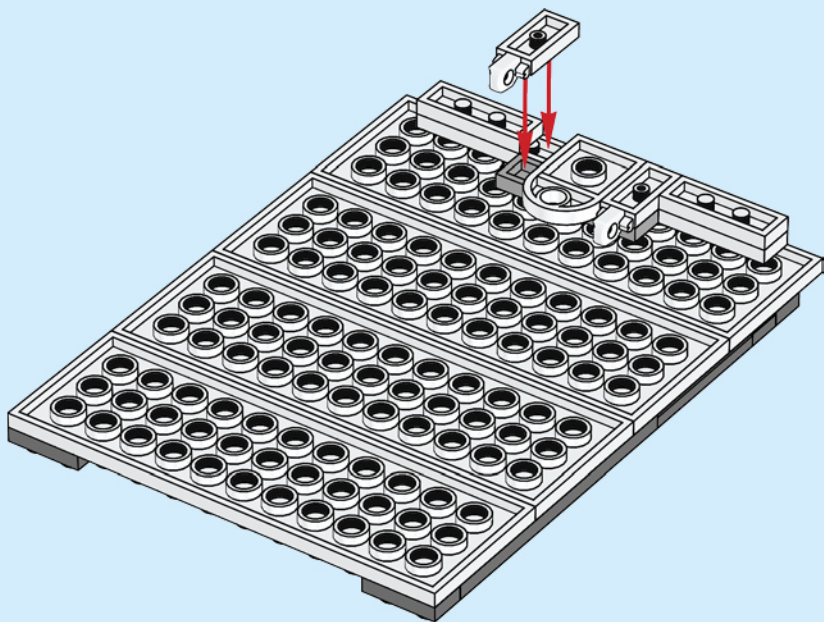

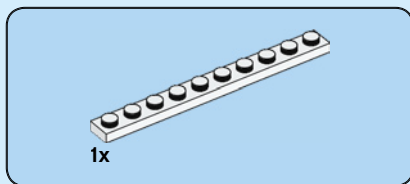

15

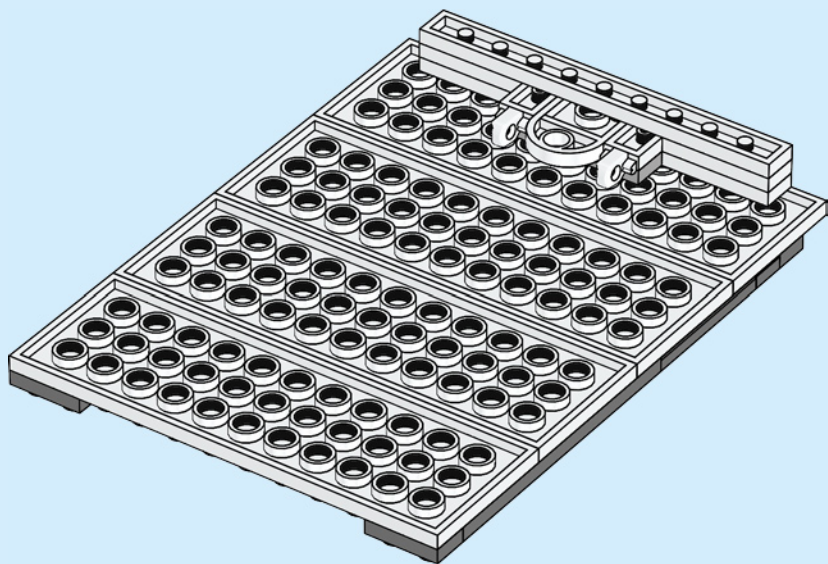

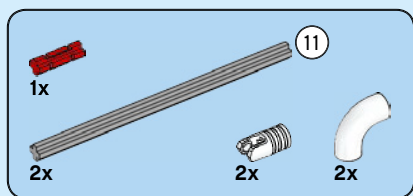

16

1

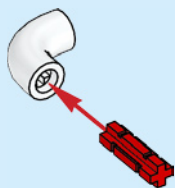

2



3

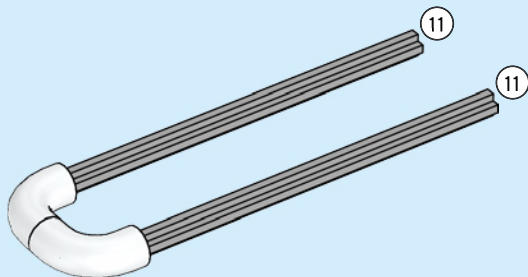

4

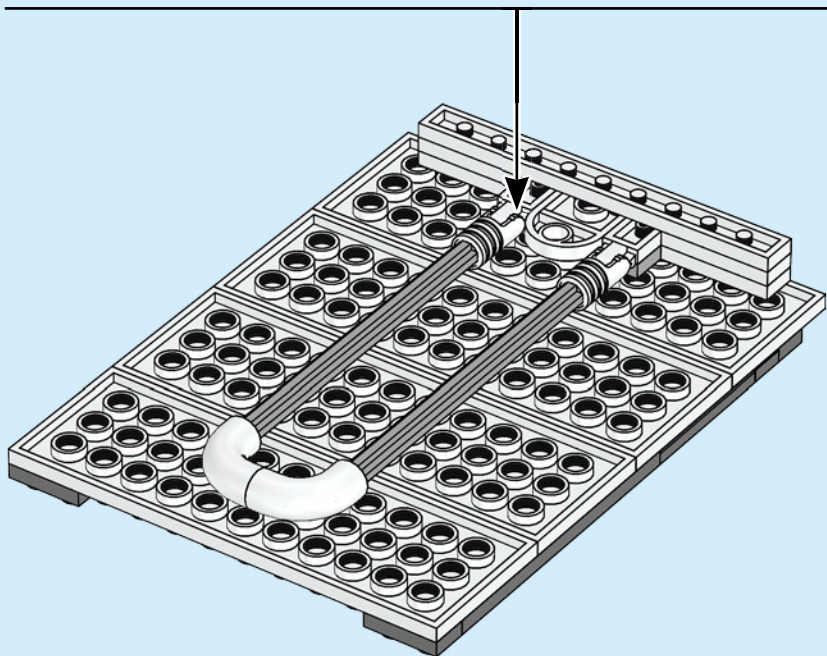
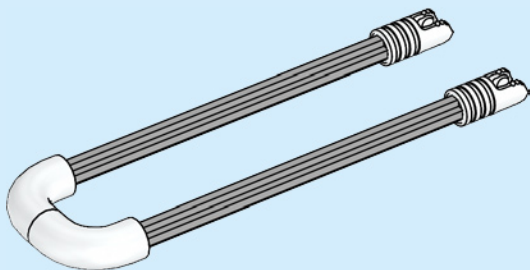

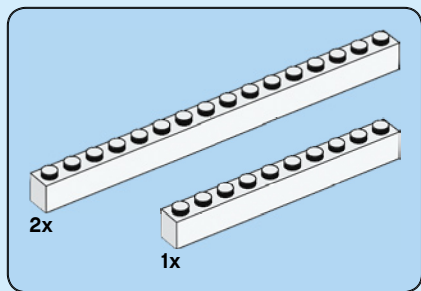

17

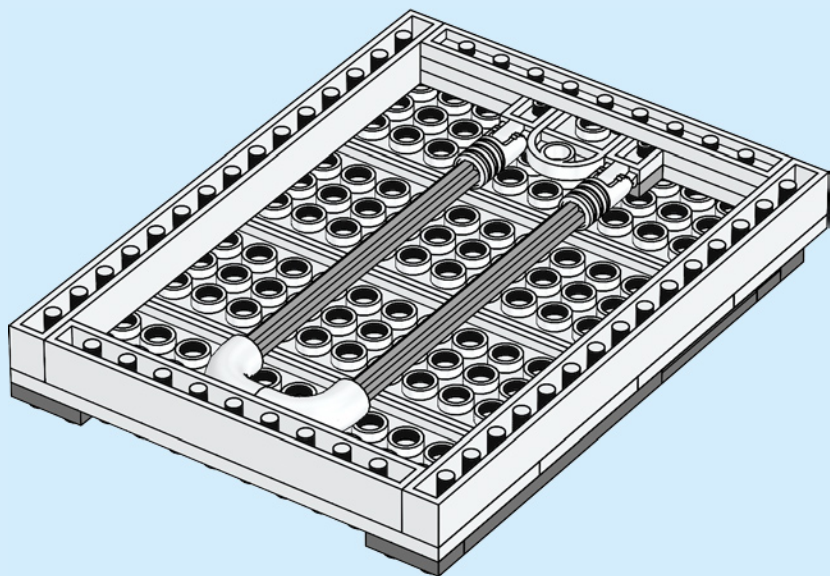



4x

18

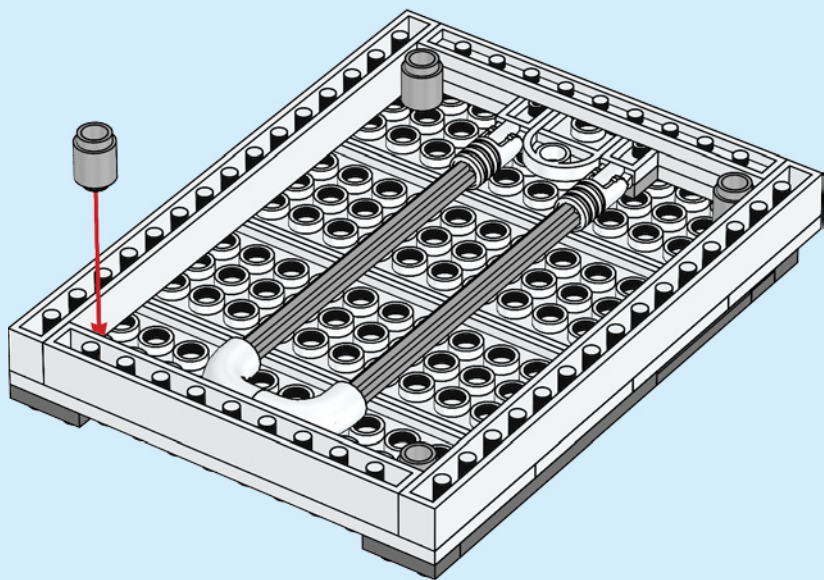



4x

19

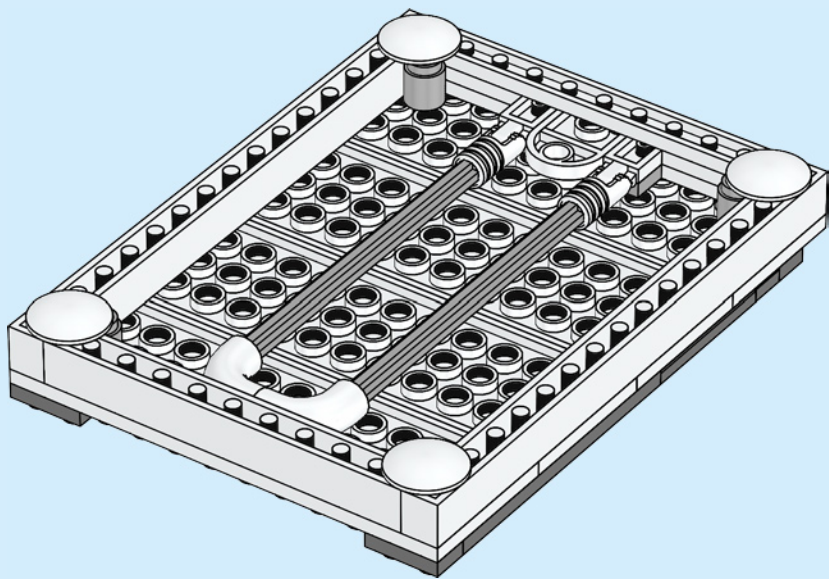



1x



1x

20

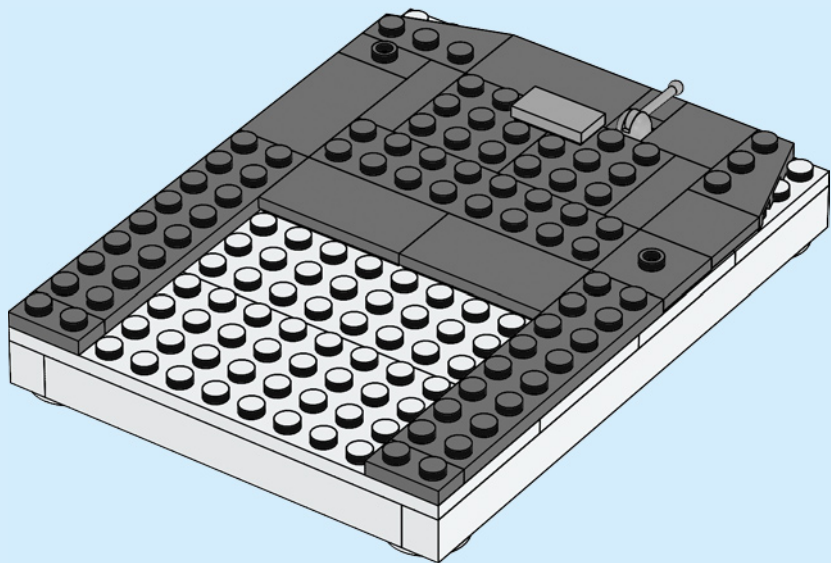
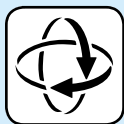



1x

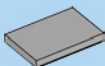

2x

21

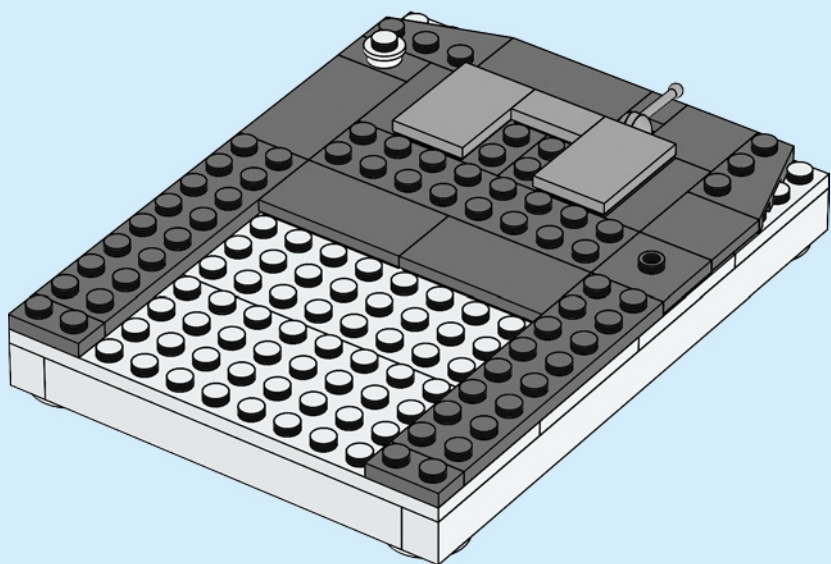

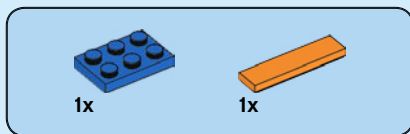

22

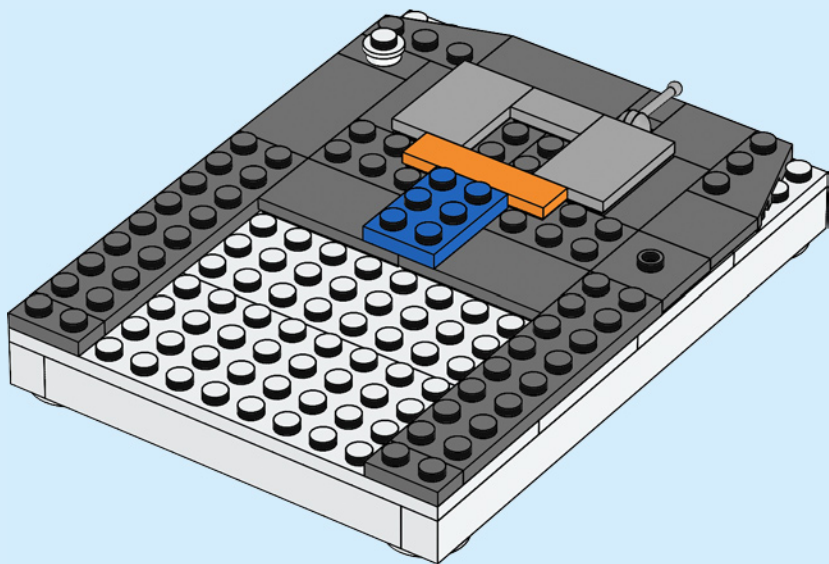



3x



2x

23

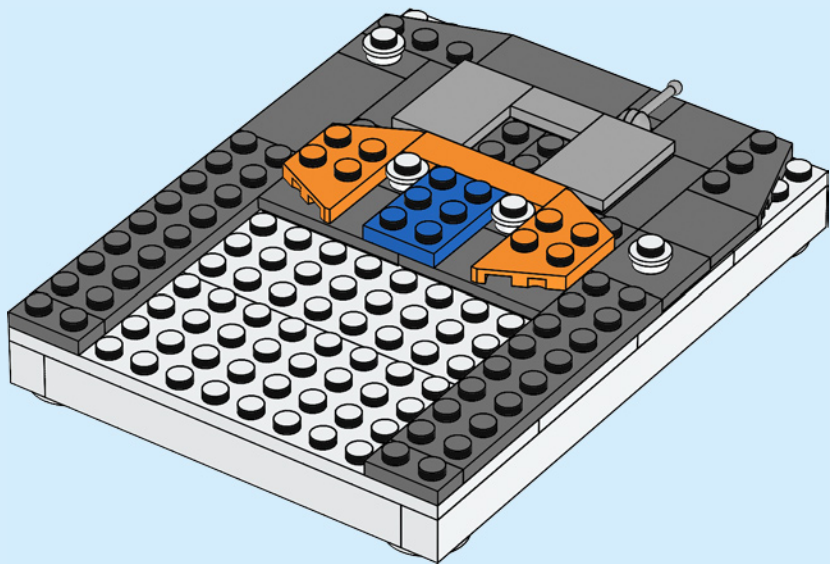

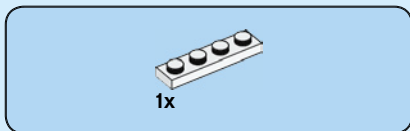
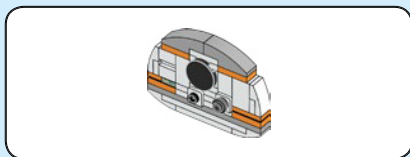

24

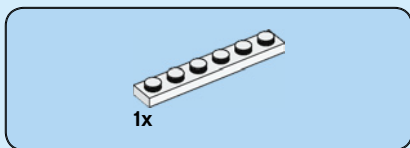
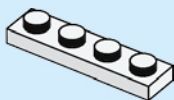

25

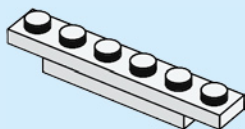

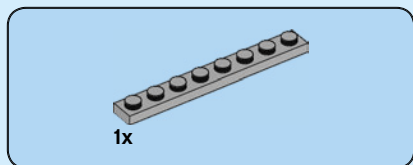

26

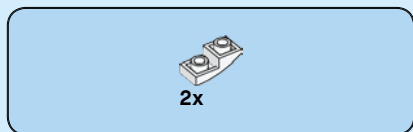
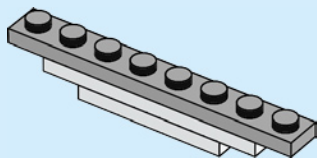

27

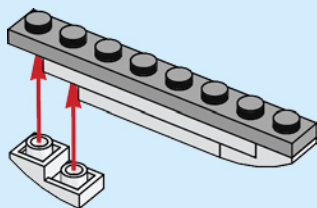



1x



1x

28

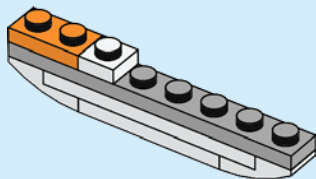

1x



1x



1x

29

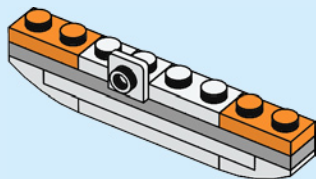



1x



1x



1x

30

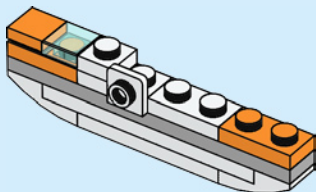

1x

31

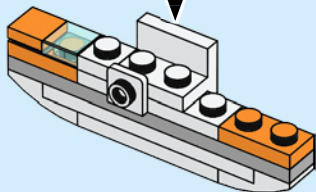
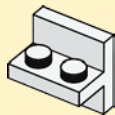



1x



1x

32

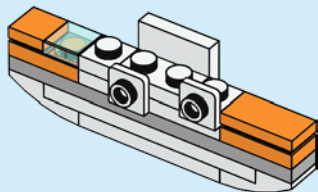

2x

33

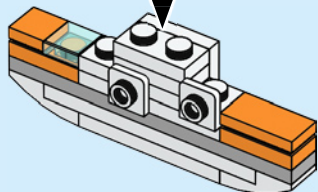
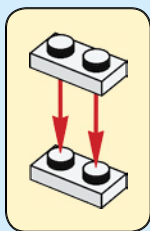



1x

34

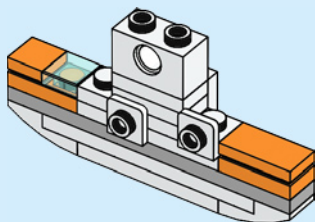

1x



2x

35

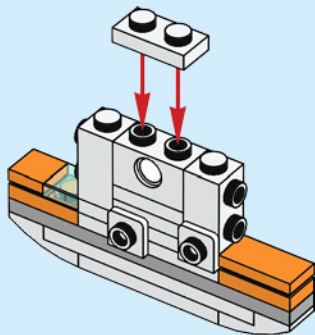

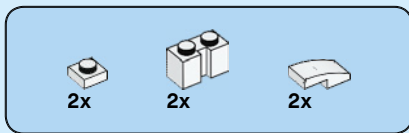

36

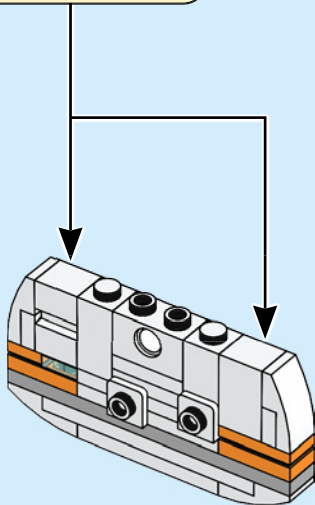
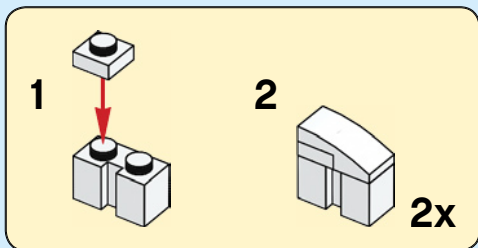



1x



2x

37

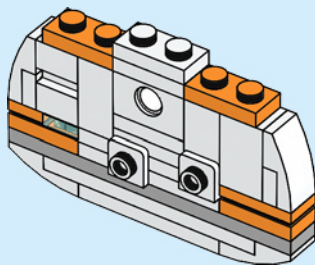

1x



2x

38

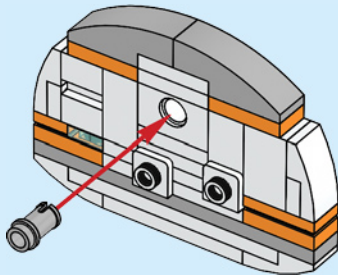



39

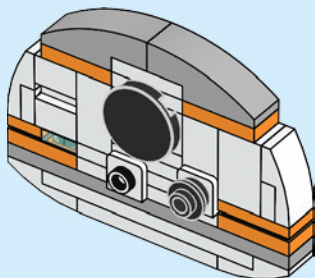

40

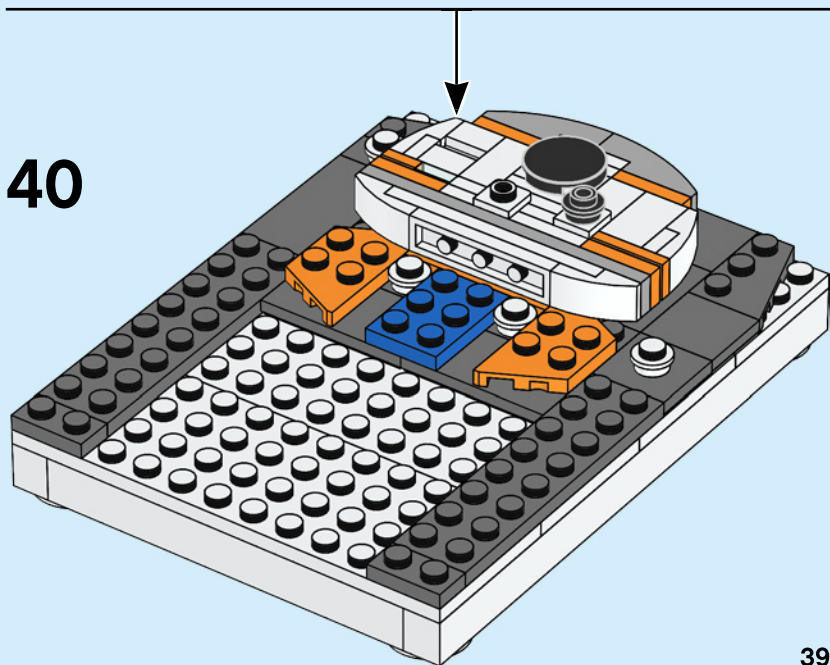

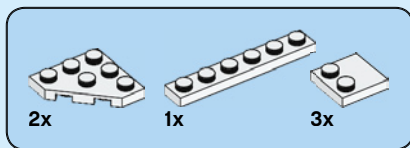

42

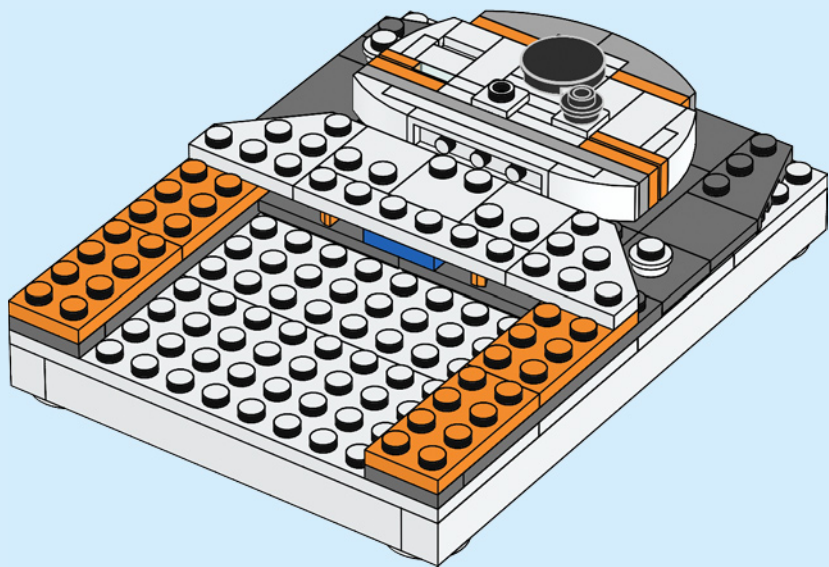



2x

43

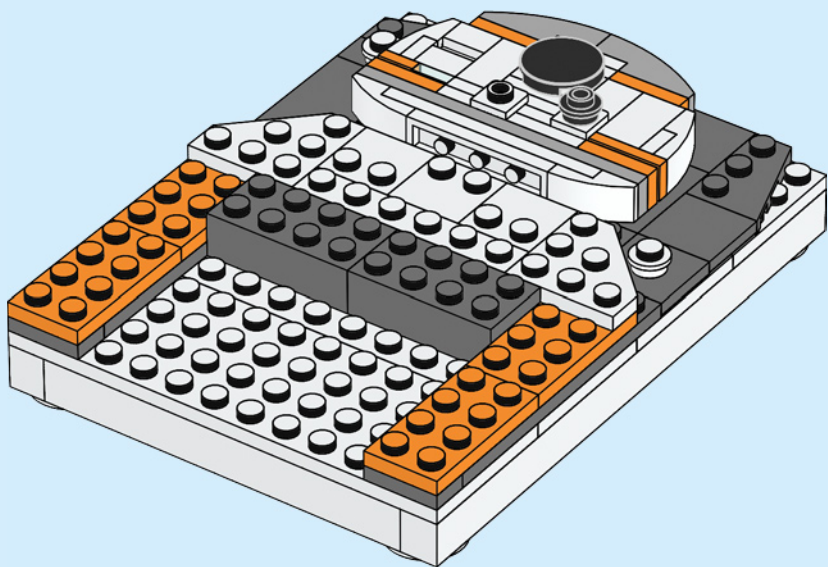

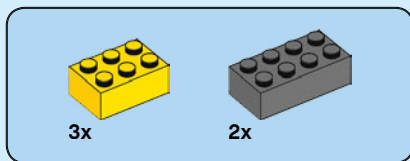

44

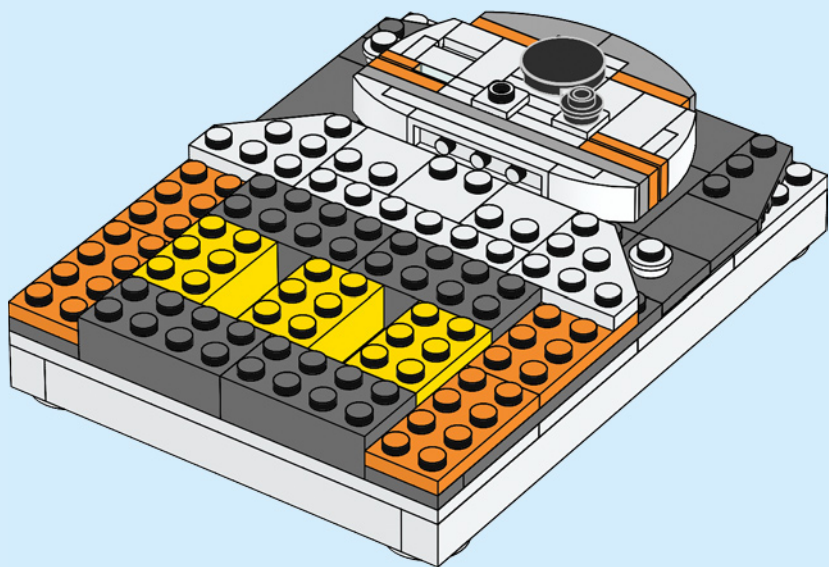



2x



6x

45

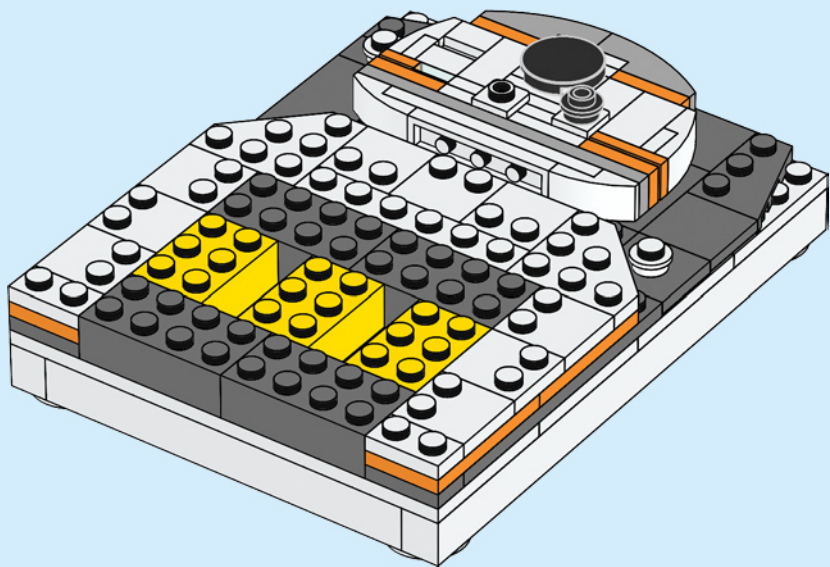



2x

46

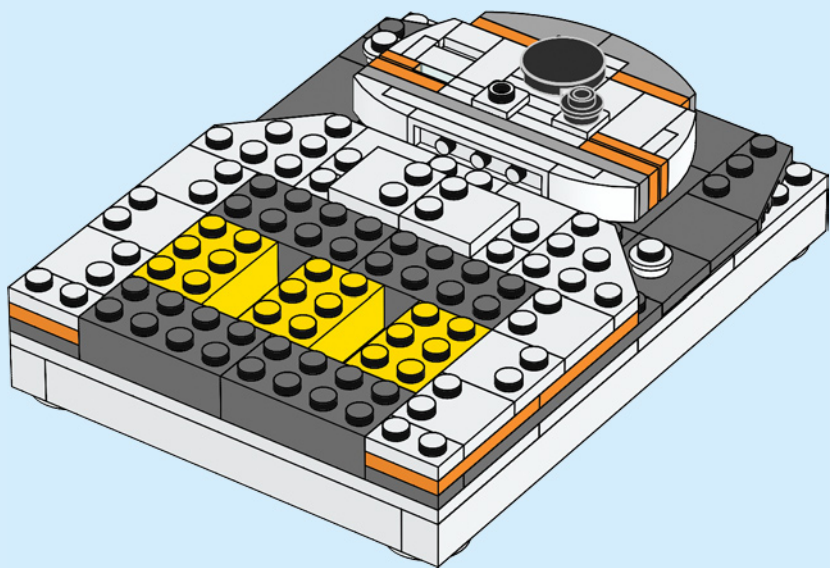



2x



1x

47

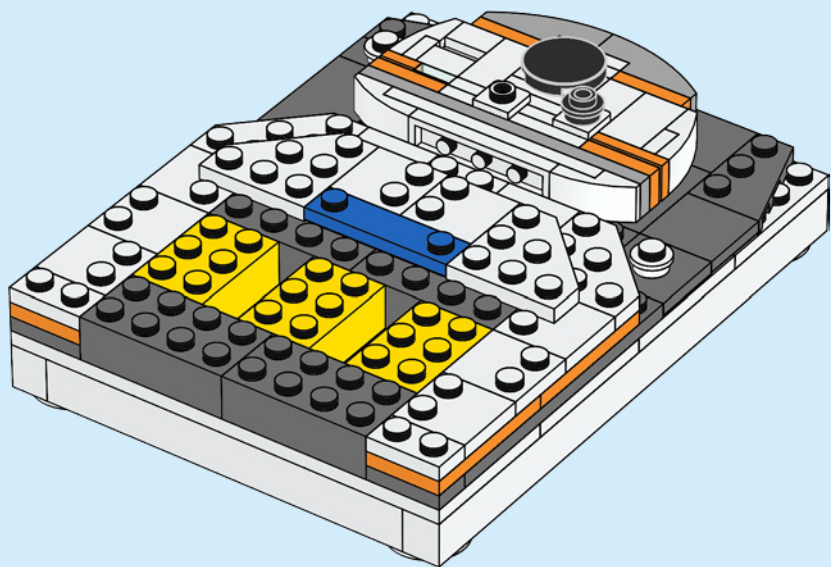



2x



4x

48

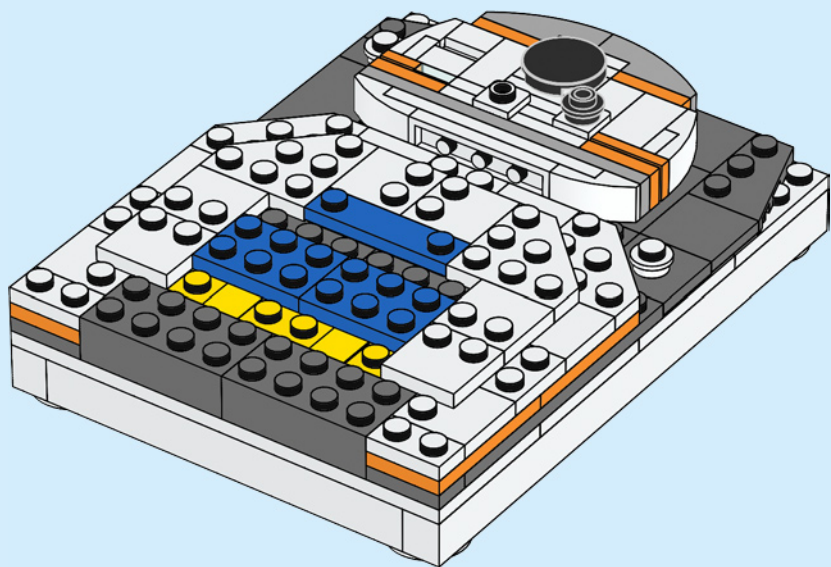

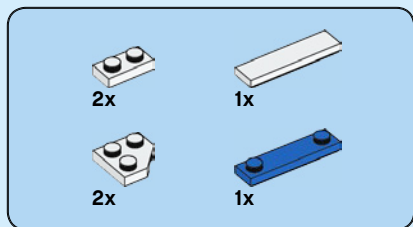

49

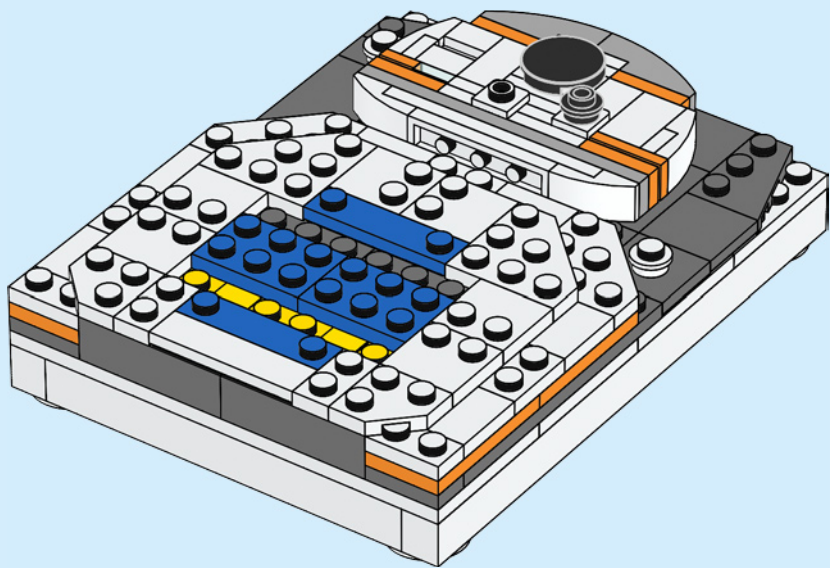



6x

50

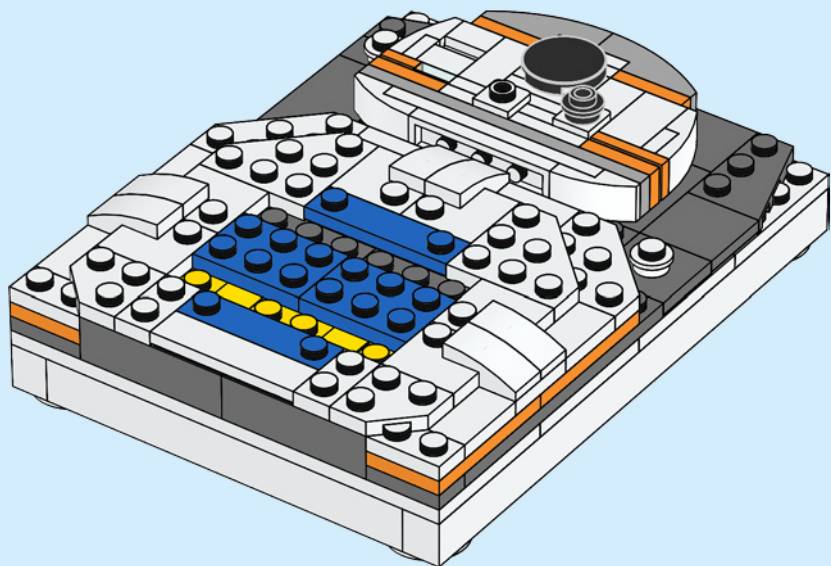

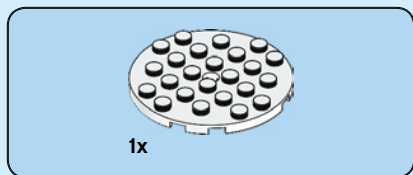

51

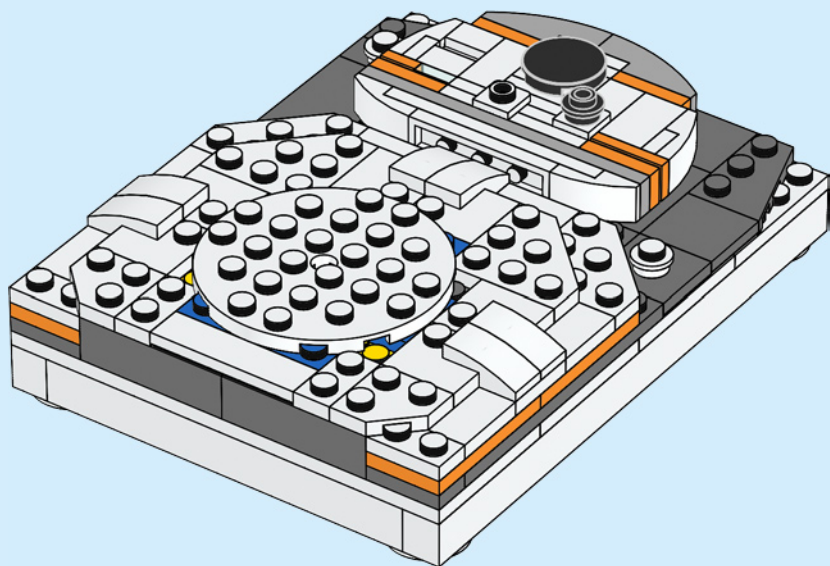



4x

52

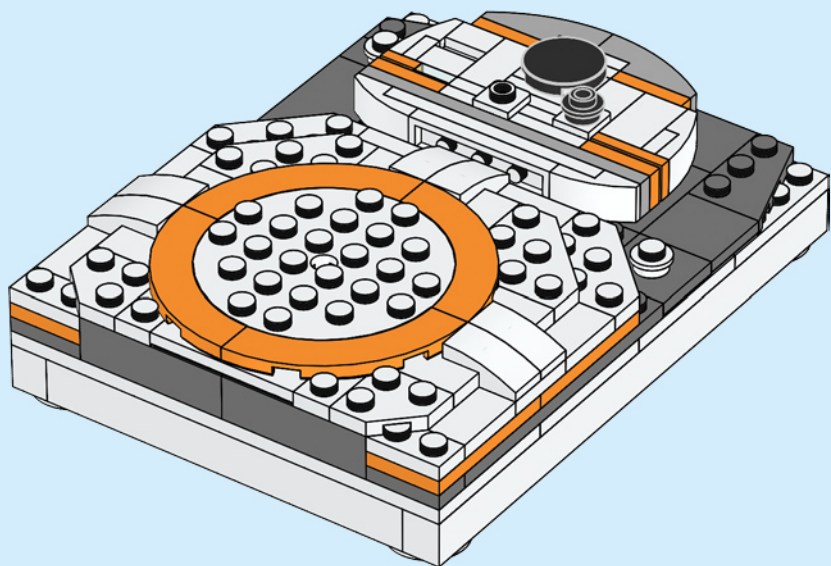



53

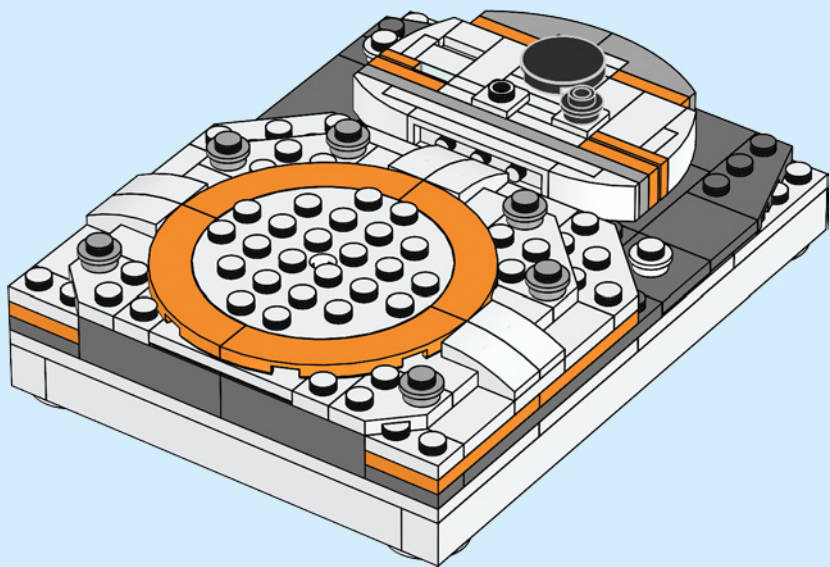



1x

54

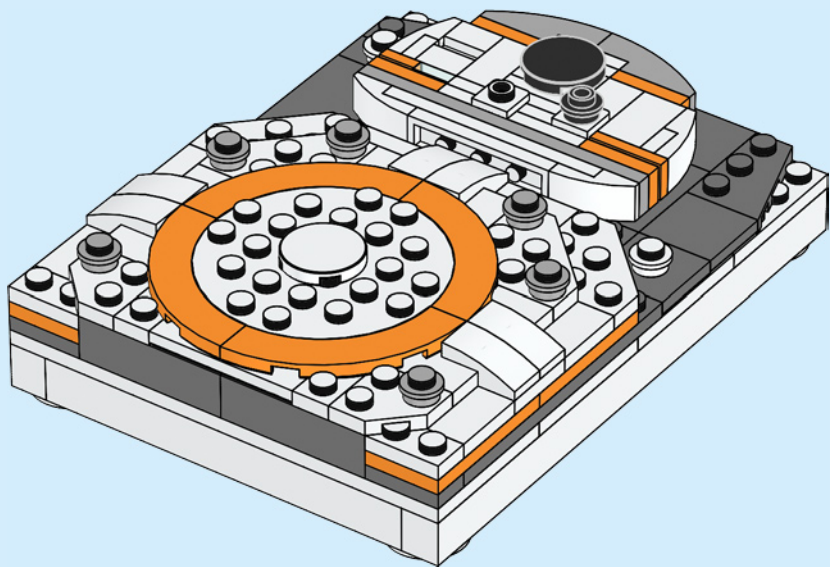

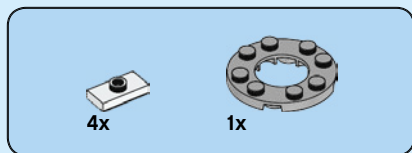

55

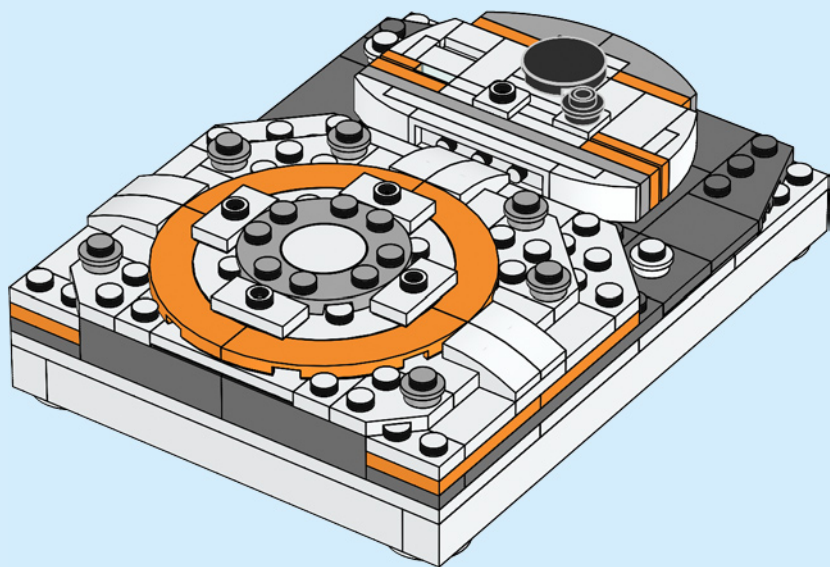



4x

56

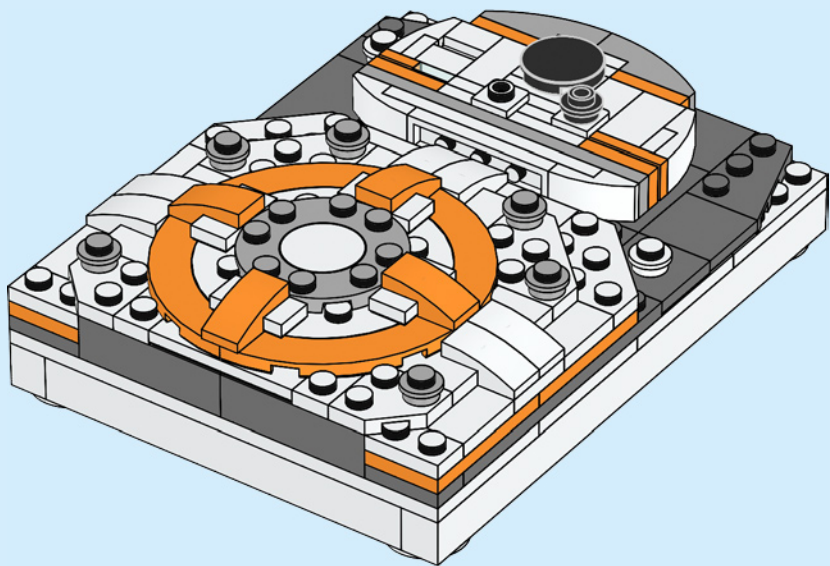



1x



1x

57

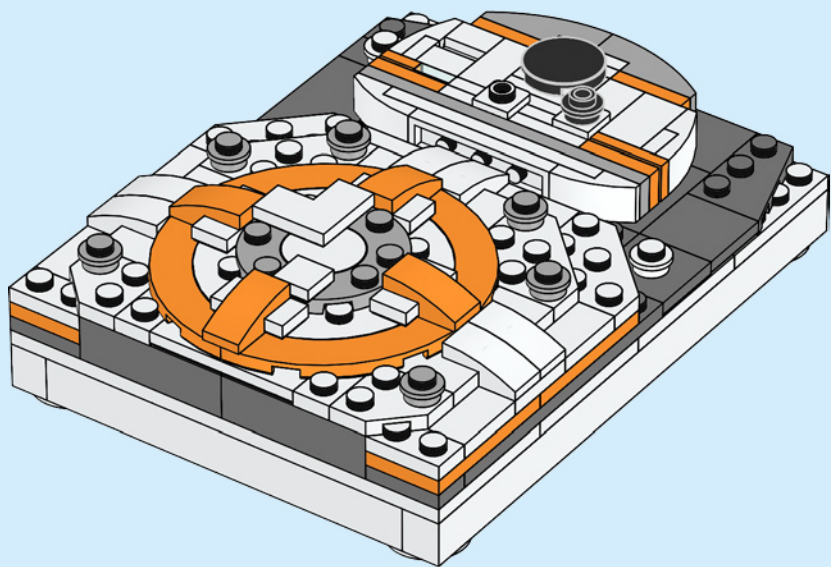

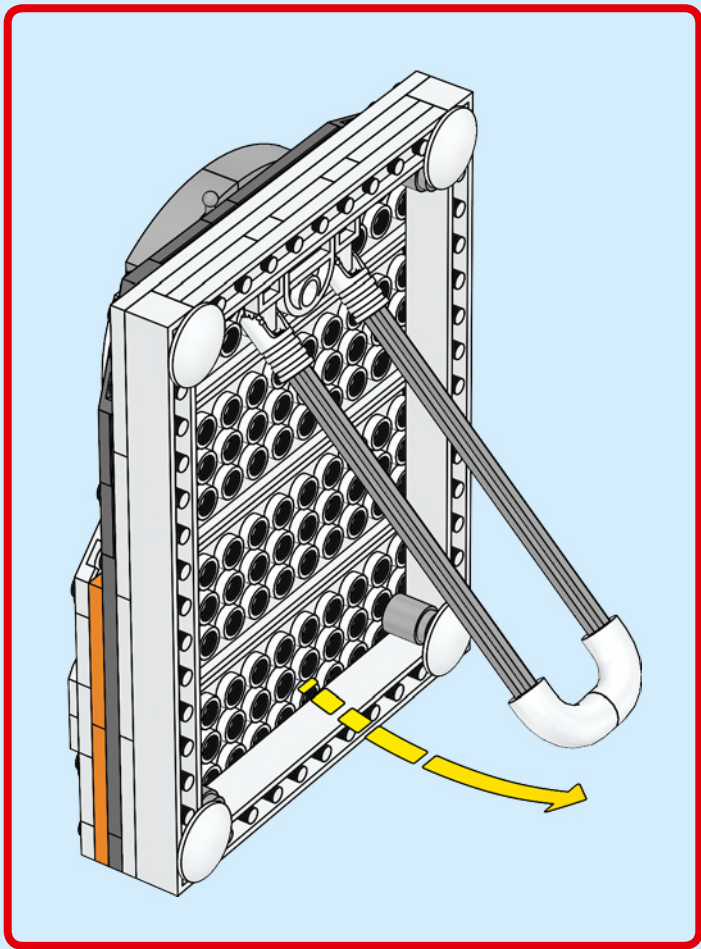

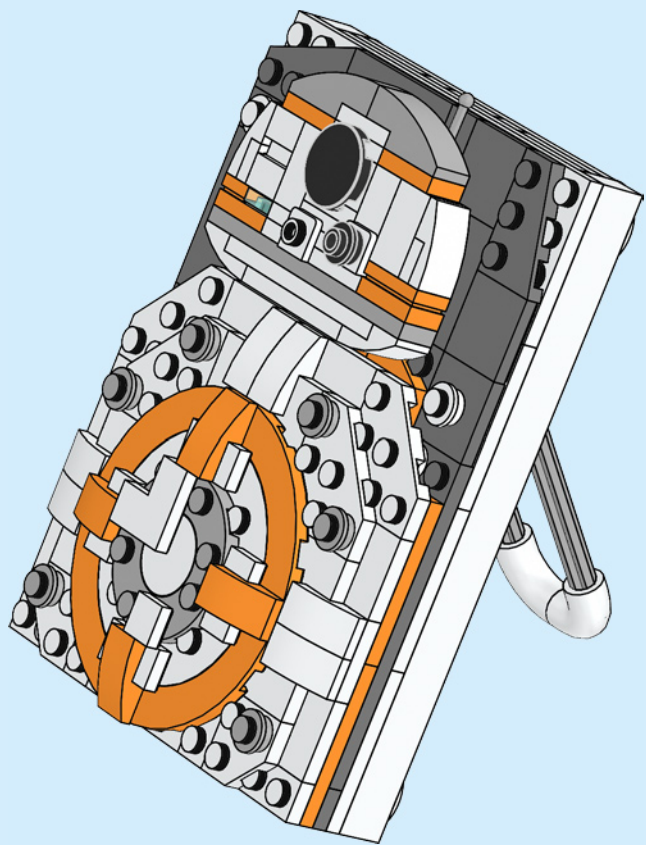

1x
6168646



1x
6070695



1x
6254256



6x
614101



4x
302401



1x
307001



2x
6218841



2x
6242241



4x
4278271



1x
6044691



2x
6271540



2x
6194851



2x
4264360



4x
6051511



1x
370001



2x
6176240



1x
6109817



2x
6109817



9x
302301



2x
6172927



8x
6034044



1x
6250019



2x
4183035



15x
6218822



1x
6058329



2x
362301



1x
6089696



1x
243101



1x
371001



4x
245001



2x
366601



2x
617894



2x
4251163



2x
617894



1x
4211445



1x
4211445



1x
611101



2x
447701



4x
4168072

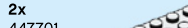

2x
246501



2x
6178172

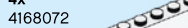

1x
6267587



4x
4211412

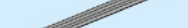

6x
4211525

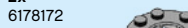

1x
4211483

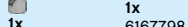

1x
4211414

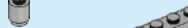

2x
4251163

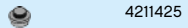

2x
617894

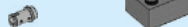

1x
4211445

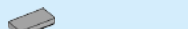

3x
4210997

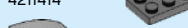

1x
4211445

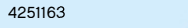

1x
4211445

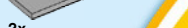

1x
4211445



1x
4211445



1x
4210848



2x
4210869



2x
4211063



1x
6092572



1x
6126083



2x
4211055



2x
4568734



2x
6039176



4x
4560184



3x
300224



4x
4560184



3x
300224



3x
300224



3x
300224



3x
300224



3x
300224



3x
300224



3x
300224



1x
4142865



3x
302123



2x
6292291



1x
4558595



4x
4177932



1x
4188771



4x
6055069



2x
6025385



1x
4160593



4x
4158355



4x
6299427



4x
6299427



4x
6299427



4x
6299427



4x
6299427



4x
6299427



4x
6299427



4x
6299427

11



Customer Service

Kundenservice

Service Consommateurs

Servicio Al Consumidor

LEGO.com/service or dial



: 00800 5346 5555

: 1-800-422-5346

WIN

GO TO WWW.LEGO.COM/PRODUCTFEEDBACK
AND GIVE US YOUR SHORT **FEEDBACK**
ABOUT THIS LEGO® SET FOR A CHANCE
TO WIN A COOL LEGO PRIZE.

Terms & Conditions apply



LEGO.com/productfeedback

GEWINNE

Erzähle uns auf
www.LEGO.com/productfeedback

etwas über die Erfahrungen, die du mit
diesem LEGO® Set gemacht hast, und
sichere dir die Chance auf einen coolen
LEGO Preis!

Es gelten die Teilnahmebedingungen

GAGNE

Rends-toi sur
www.LEGO.com/productfeedback

et donne-nous quelques commentaires
sur ce produit LEGO® pour avoir une
chance de gagner un prix LEGO !

Voir Conditions Générales

GANA

Visita
www.LEGO.com/productfeedback

y envíanos tu opinión acerca de este
set LEGO®. ¡Participarás en el sorteo
de un premio LEGO!

Términos y Condiciones aplicables

获取奖品

登录
www.LEGO.com/productfeedback

给出关于此乐高®套装的简短反馈，
就有机会获得炫酷乐高奖品

《条款及条件》适用

경품 당첨 기회

www.LEGO.com/productfeedback

페이지로 이동하여 이 레고® 세트에 대한
간략한 피드백을 보내 주시고 멋진 레고
경품을 탈 수 있는 기회도 잡으십시오

약관 적용

ЗАПОЛНИ АНКЕТУ И ПОЛУЧИ ПРИЗ

Перейди по ссылке
www.LEGO.com/productfeedback

ответь всего на несколько во-
просов об этом наборе LEGO®,
и у тебя появится шанс выиграть за-
мечательный приз от компании LEGO.

Применяются Условия и правила
участия

LEGO and the LEGO logo are trademarks of the/son des marques de commerce du/
son marcas registradas de LEGO Group. ©2020 The LEGO Group.

STARWARS.COM © & ™ Lucasfilm Ltd.

6327719