

3429

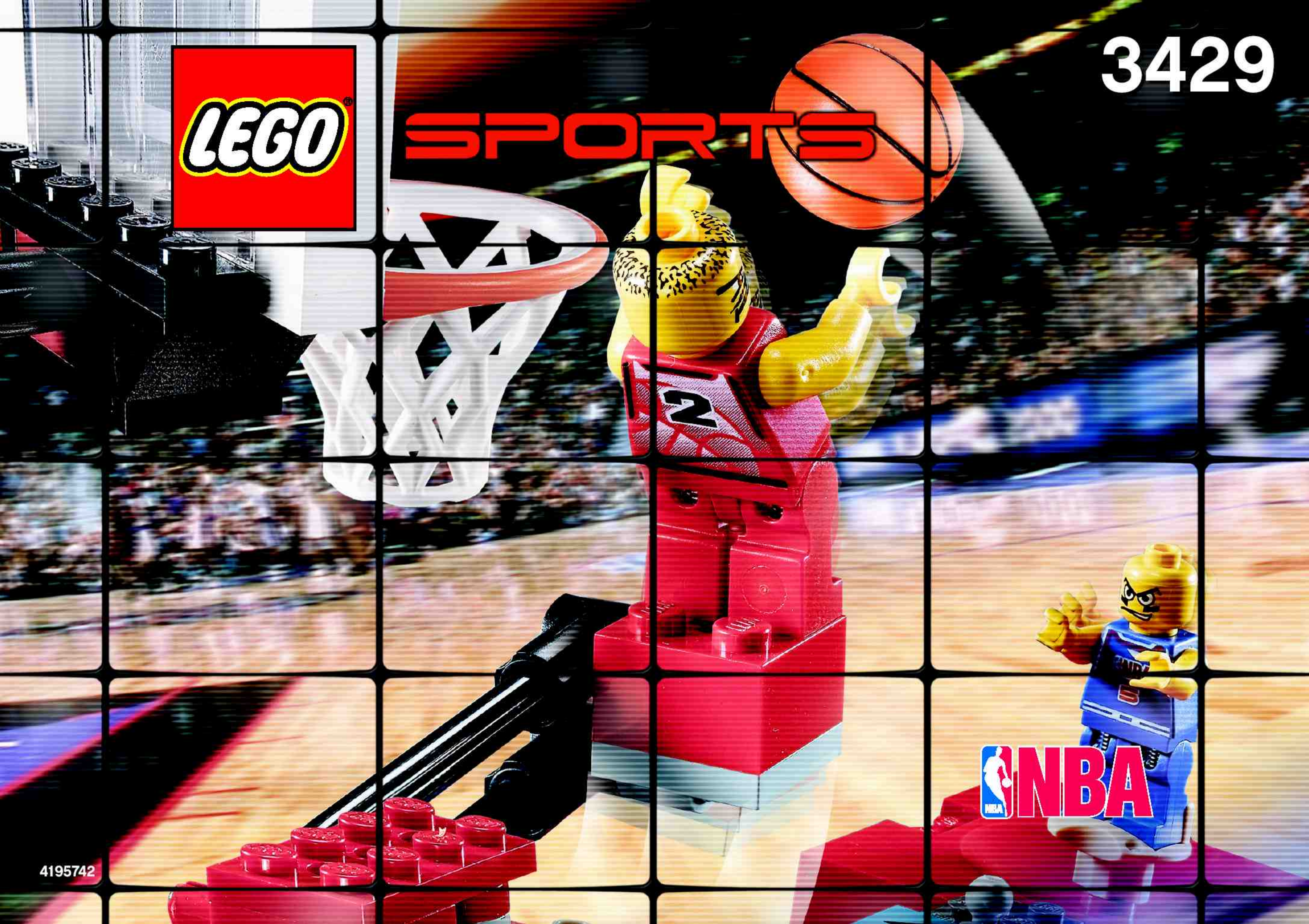

SPORTS



4195742



3427



3429



3430



3431



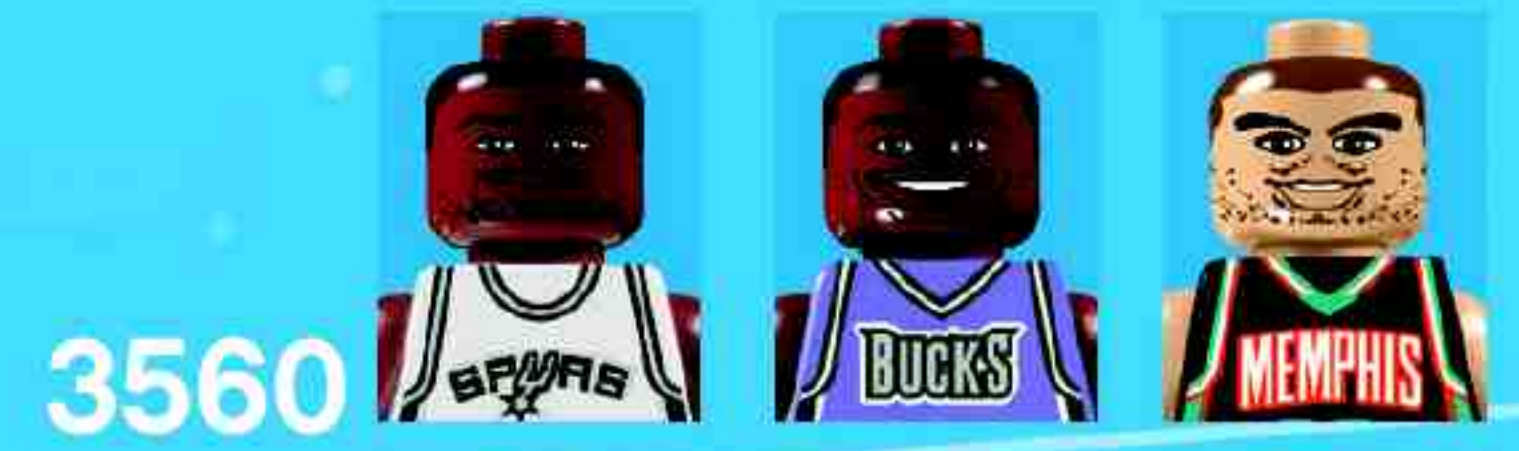

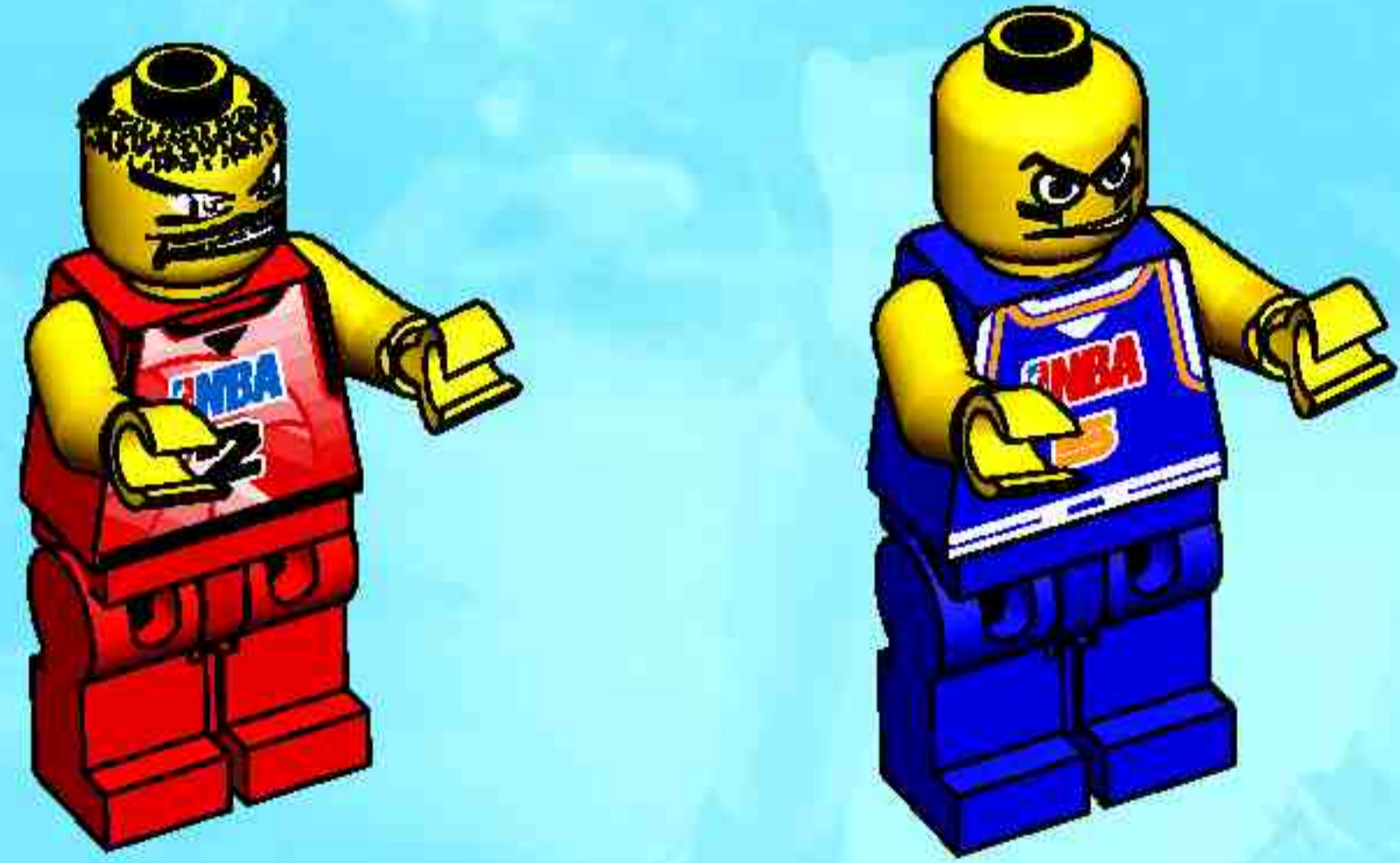
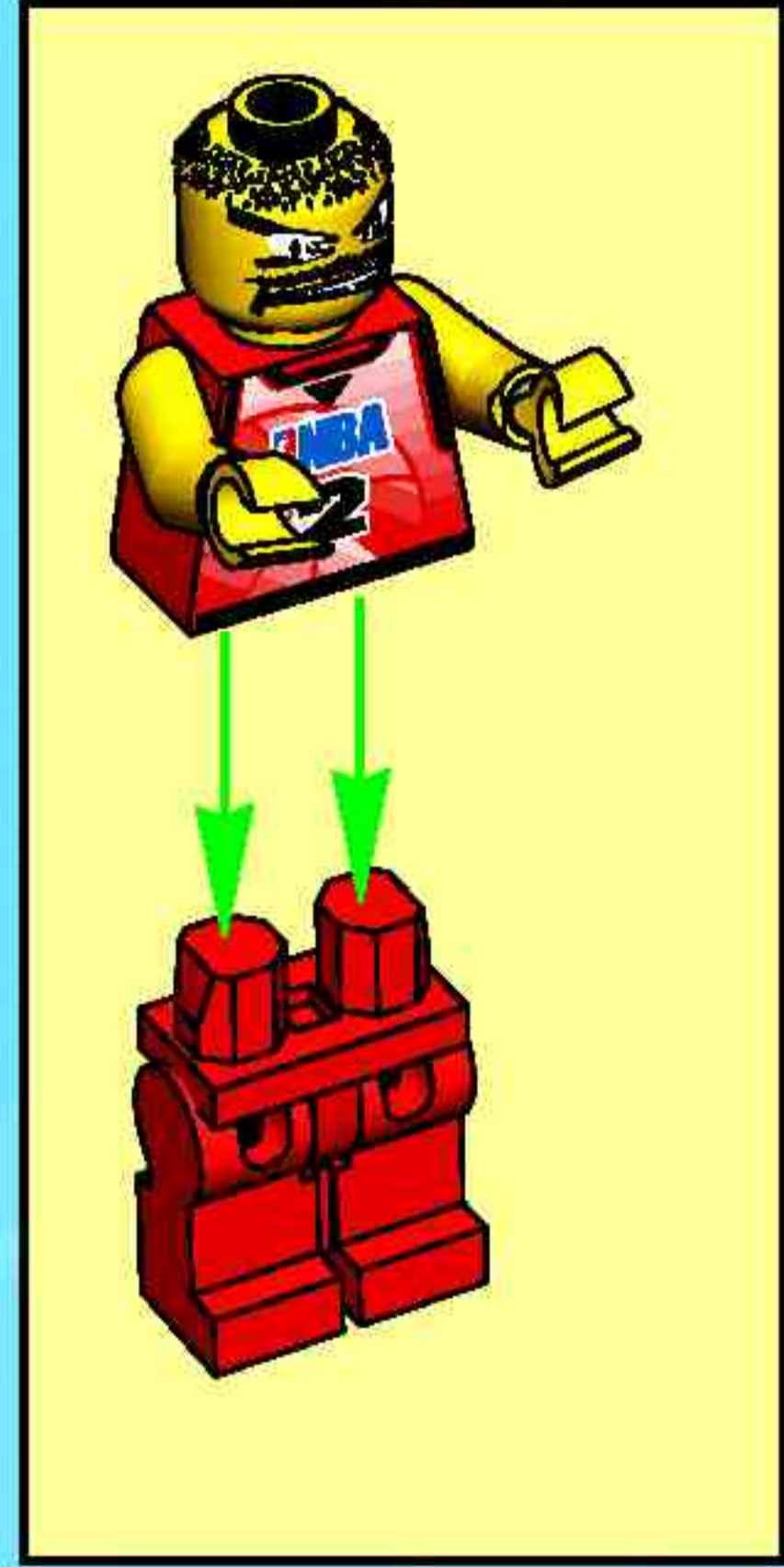

1

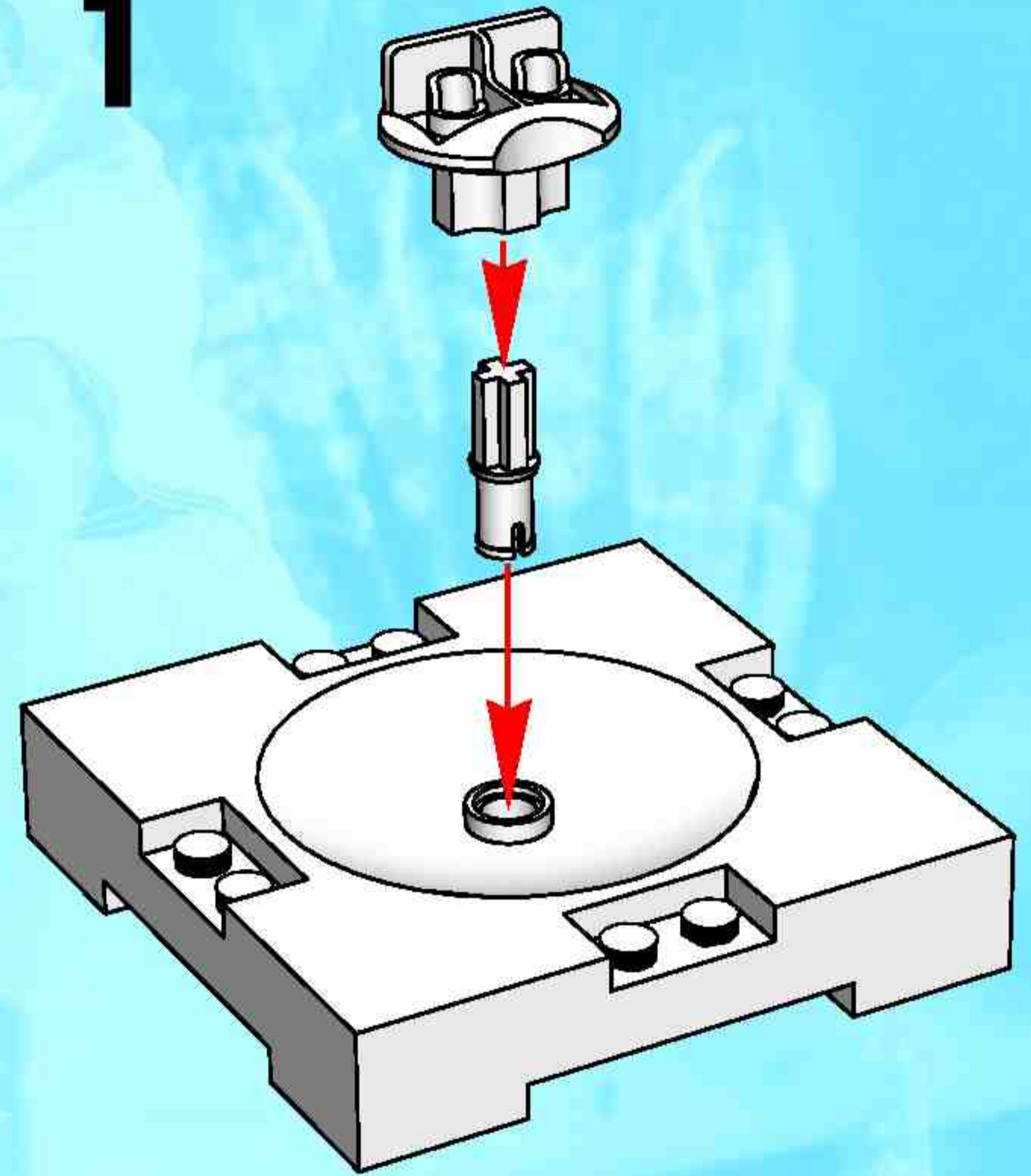

2

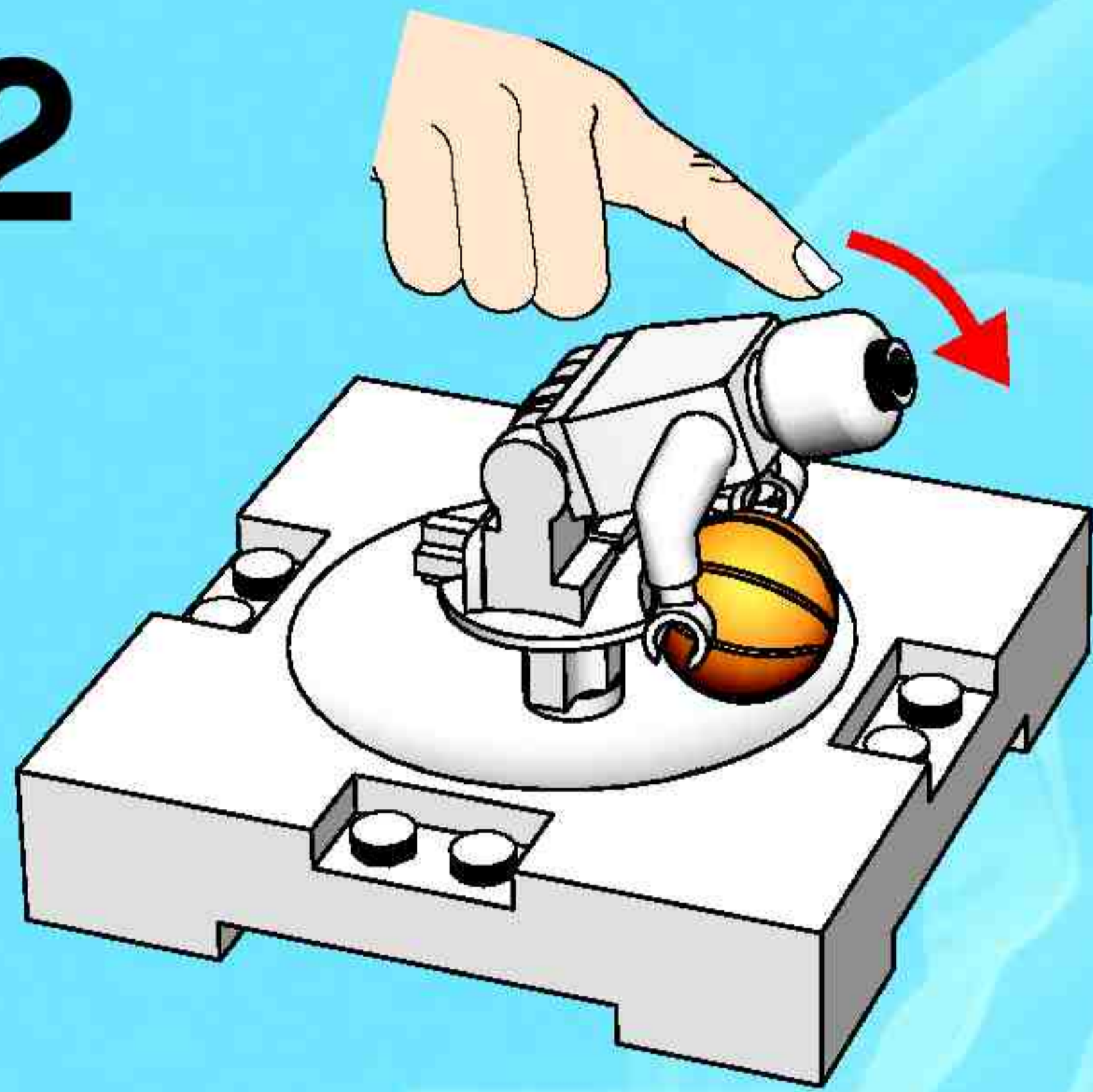

3

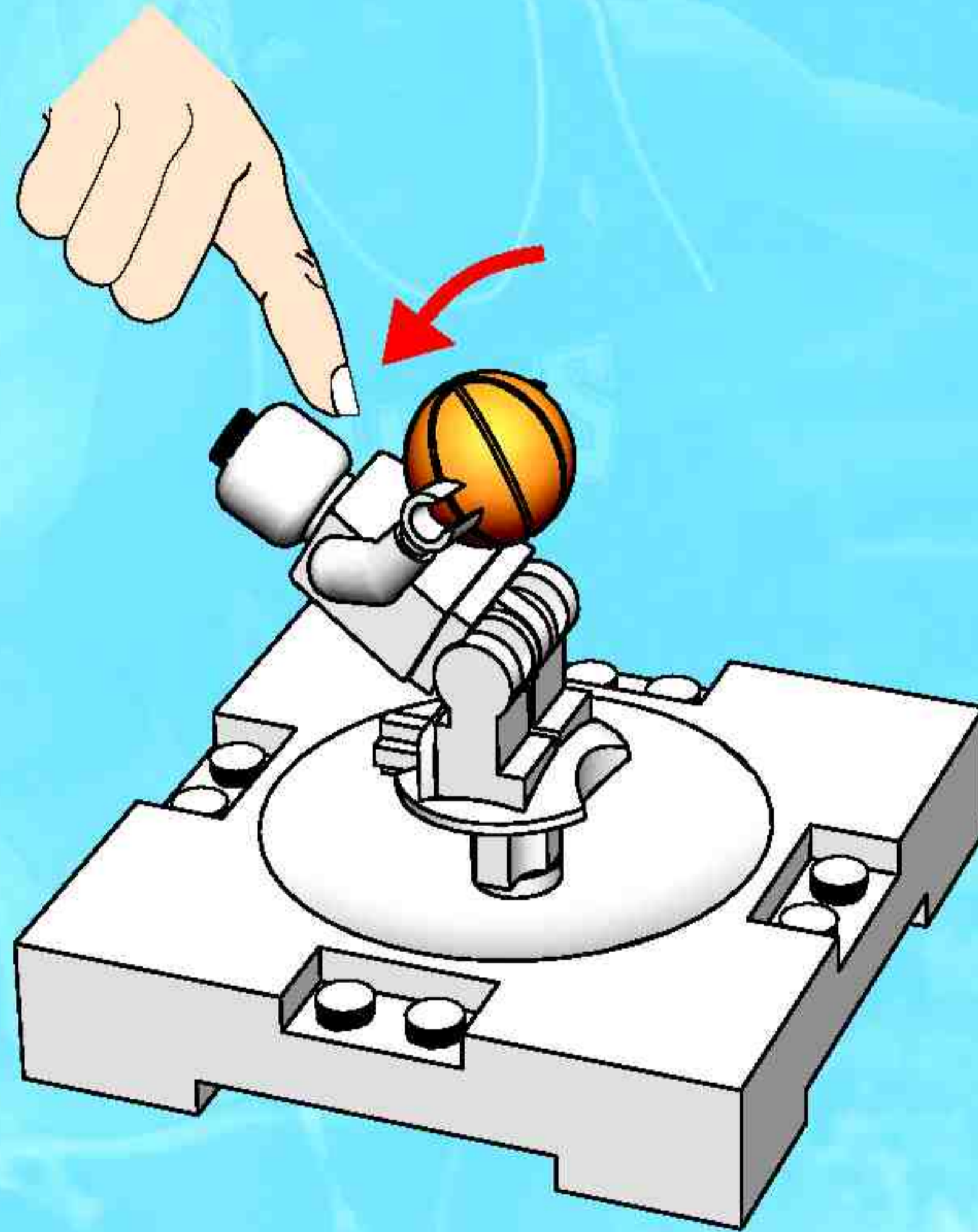

4

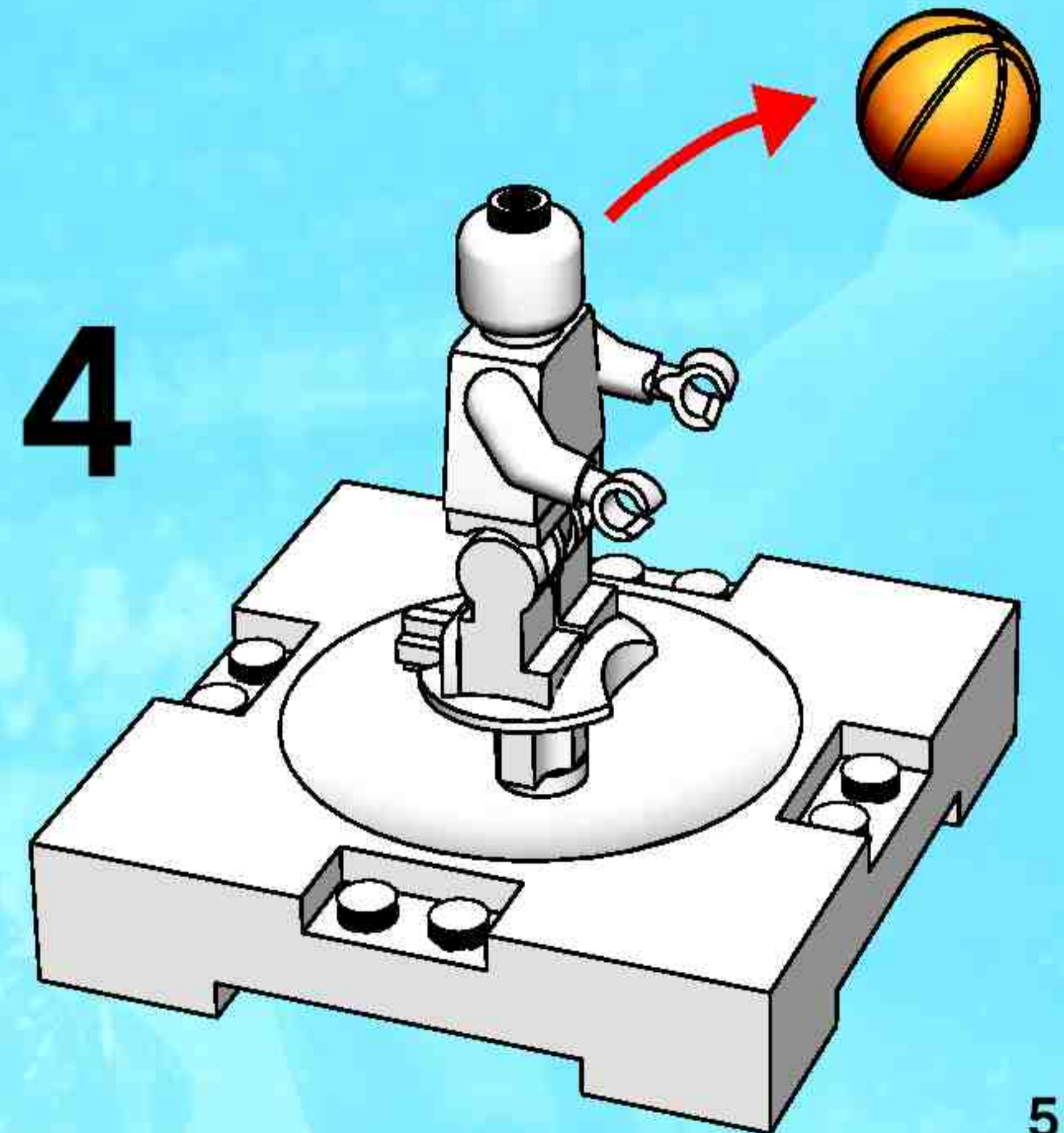

5

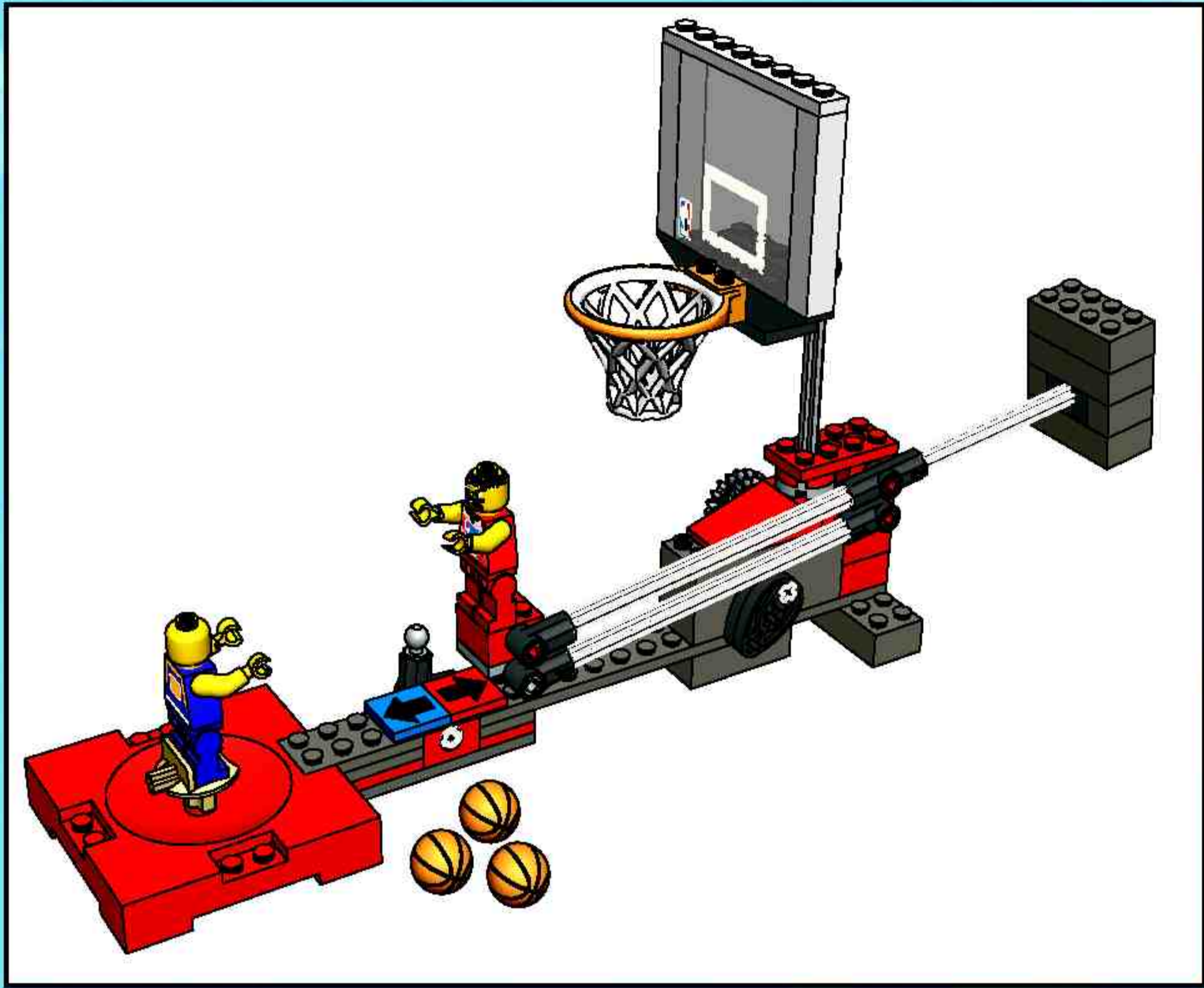

1

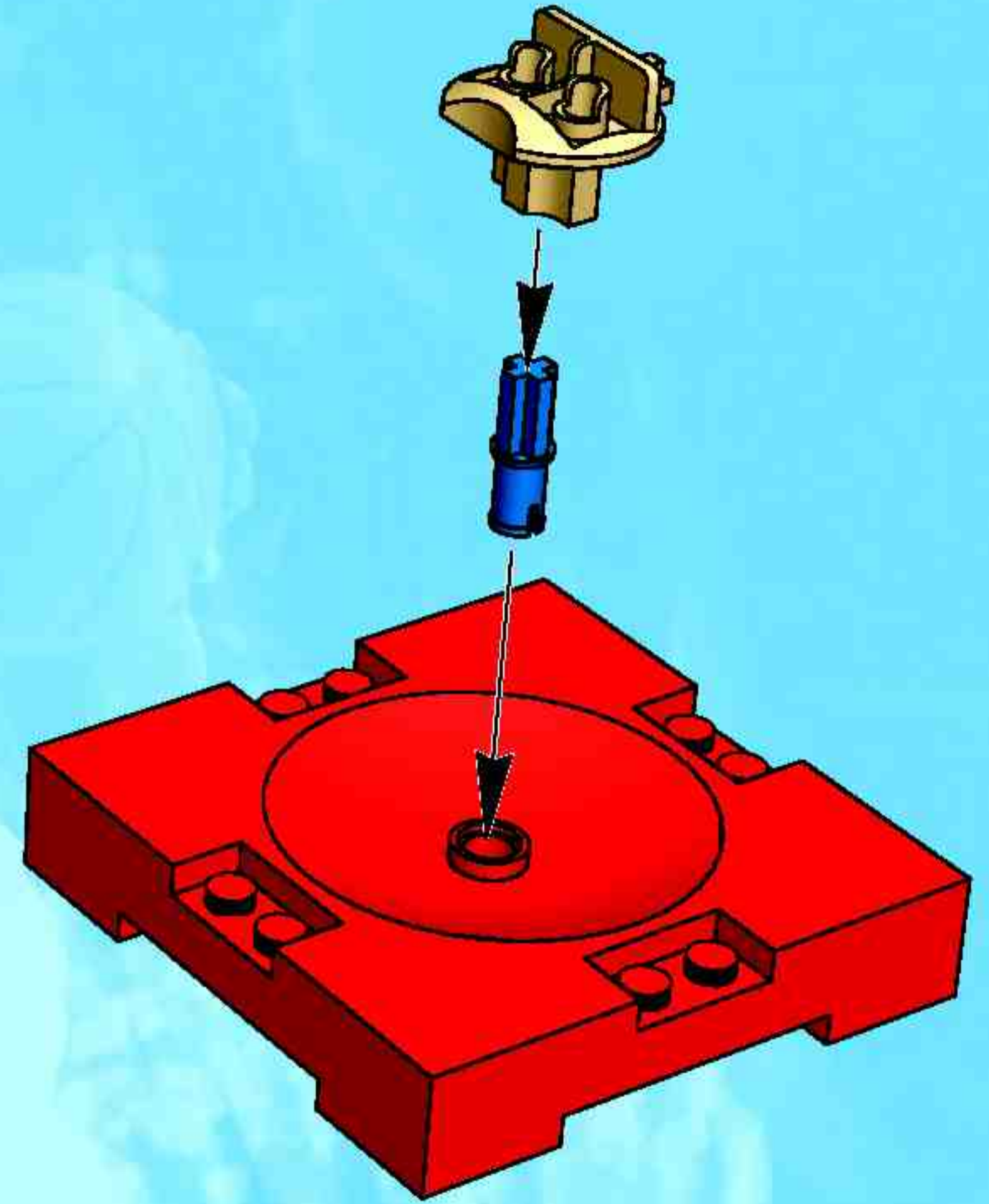

2

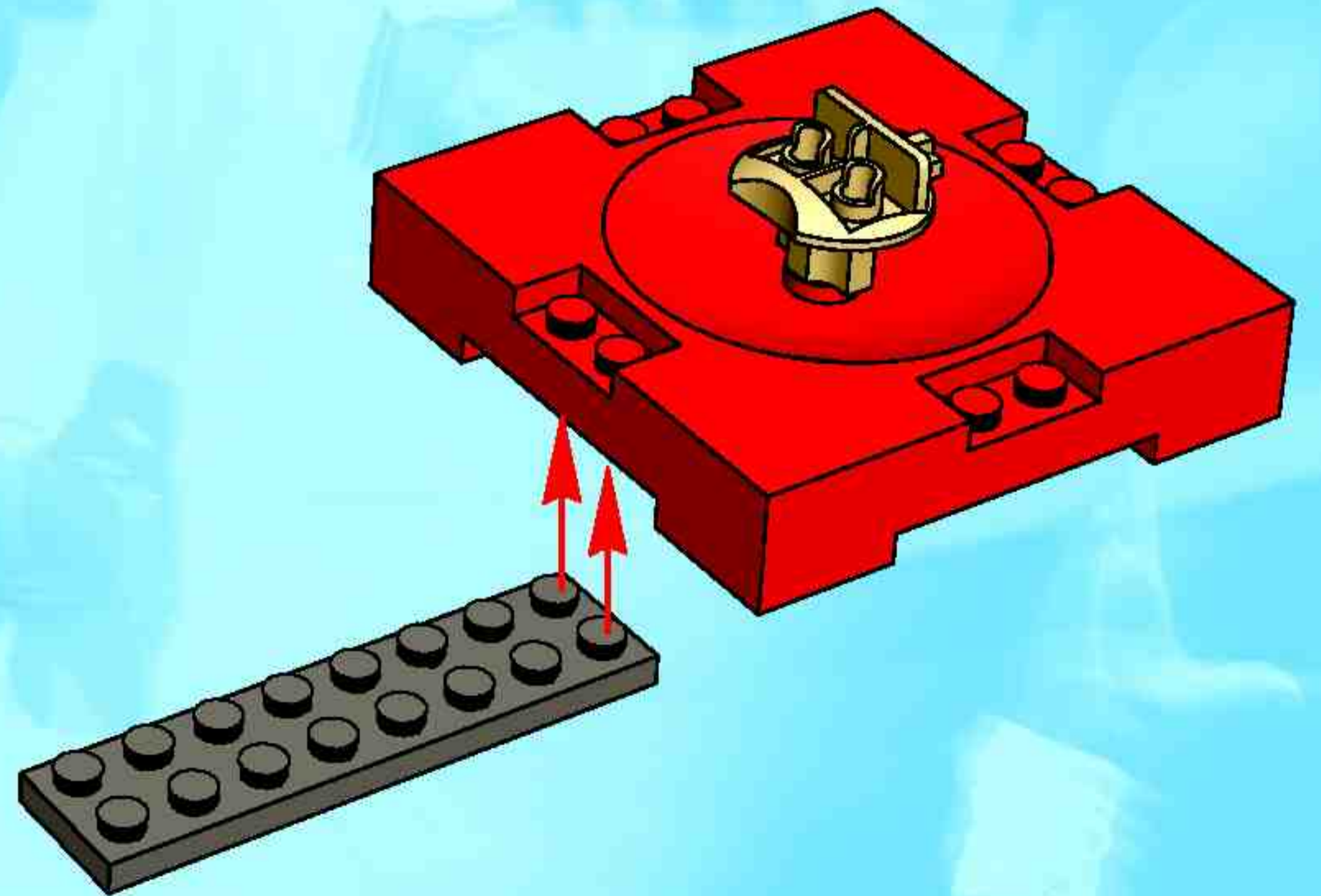

3

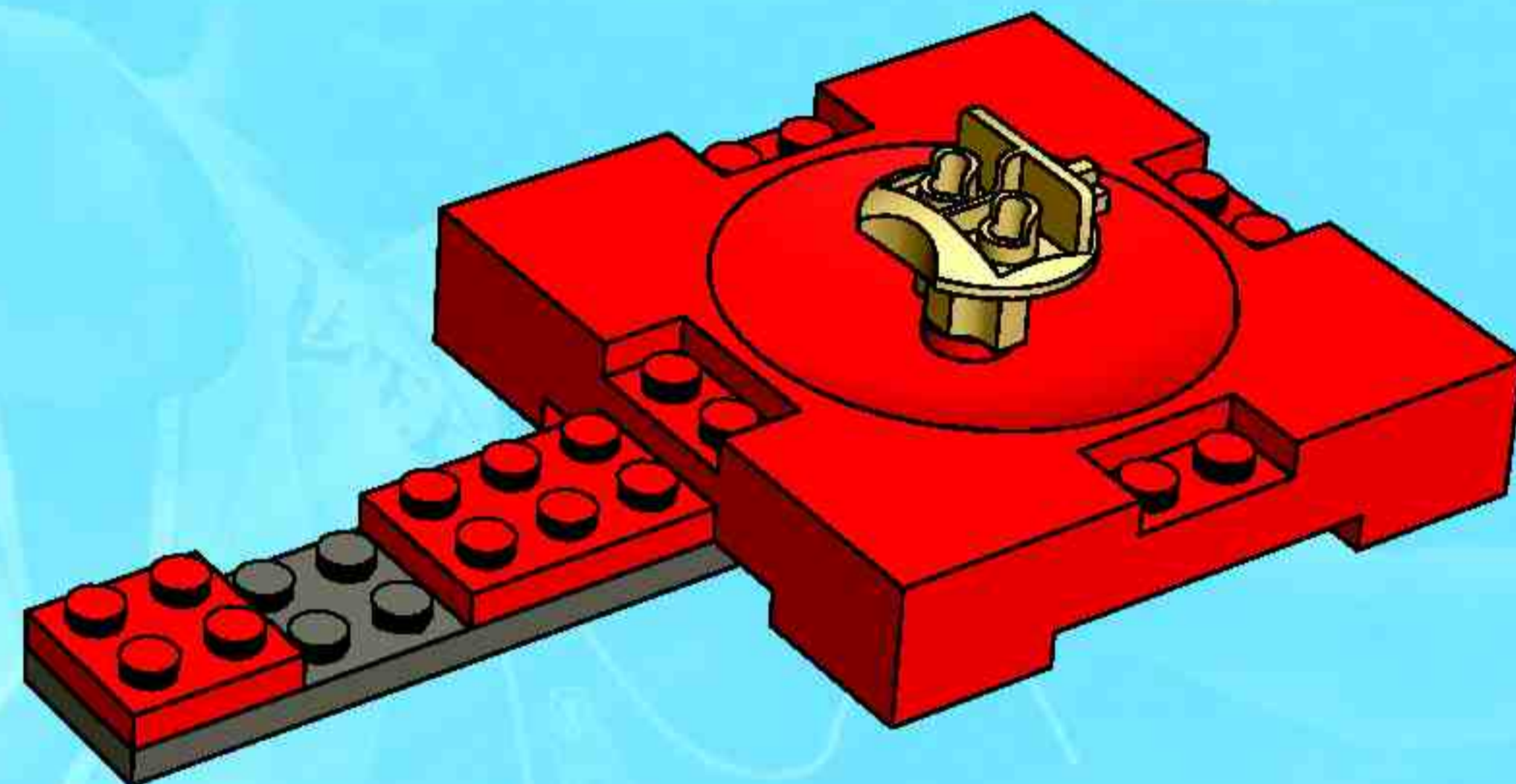

4

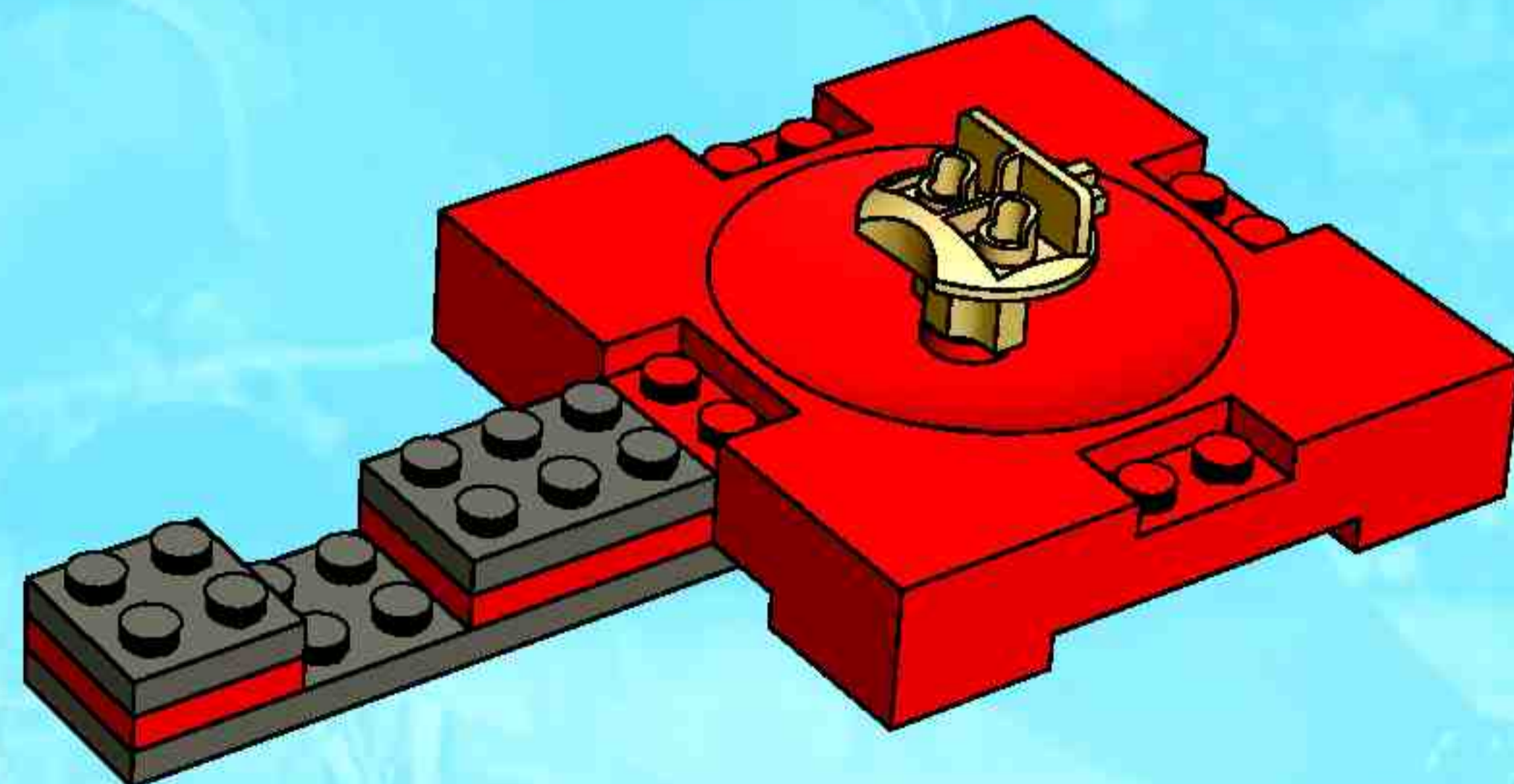

5

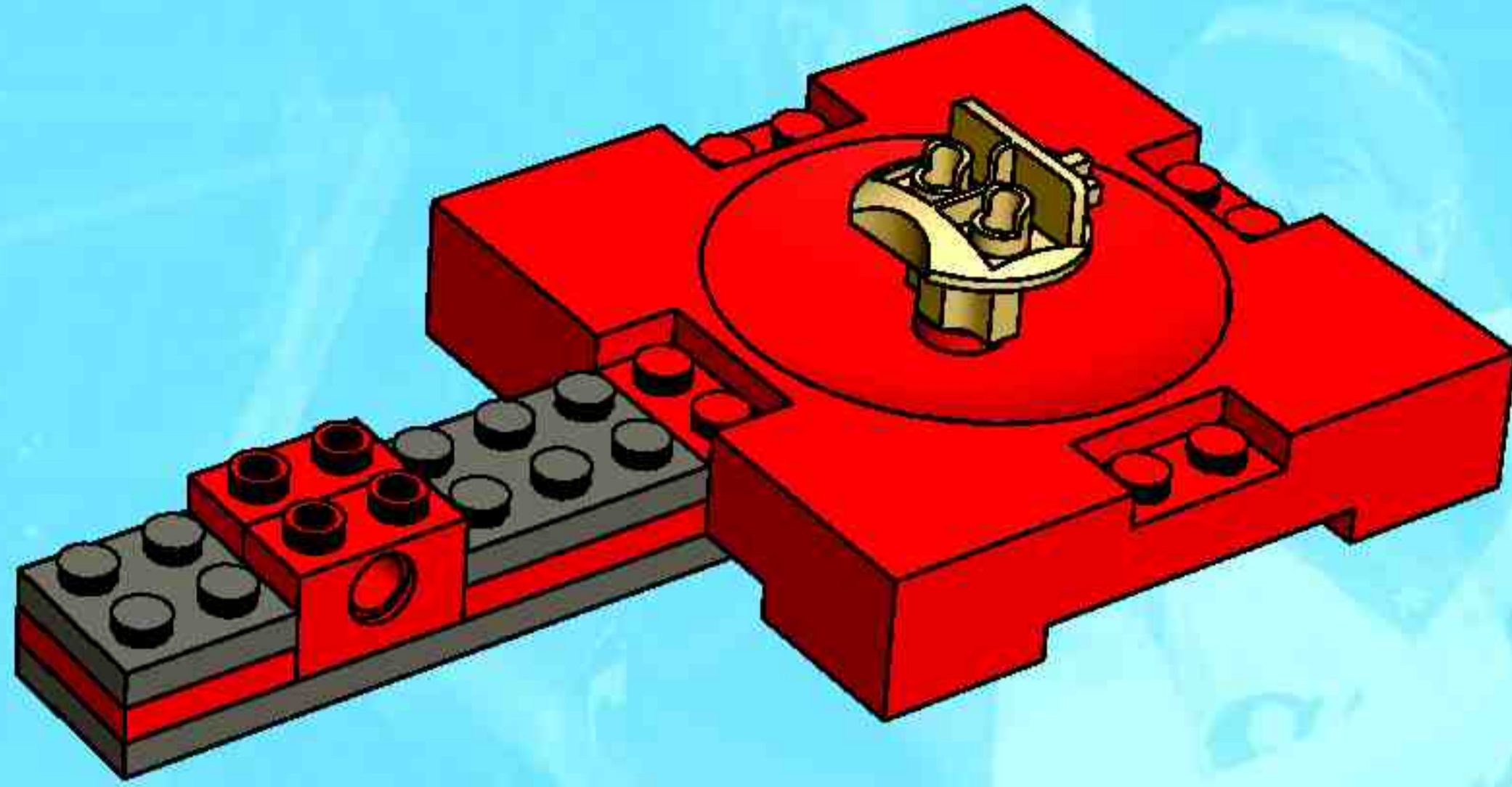

6

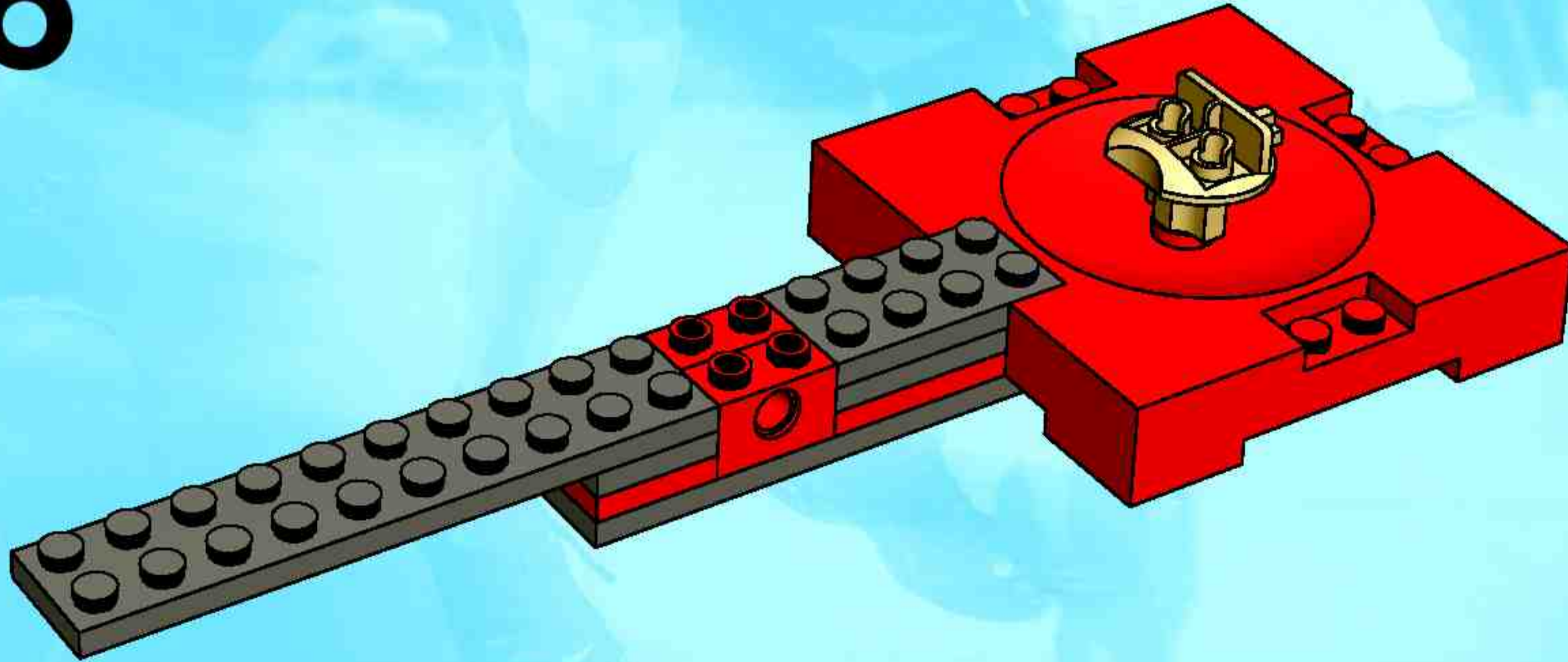

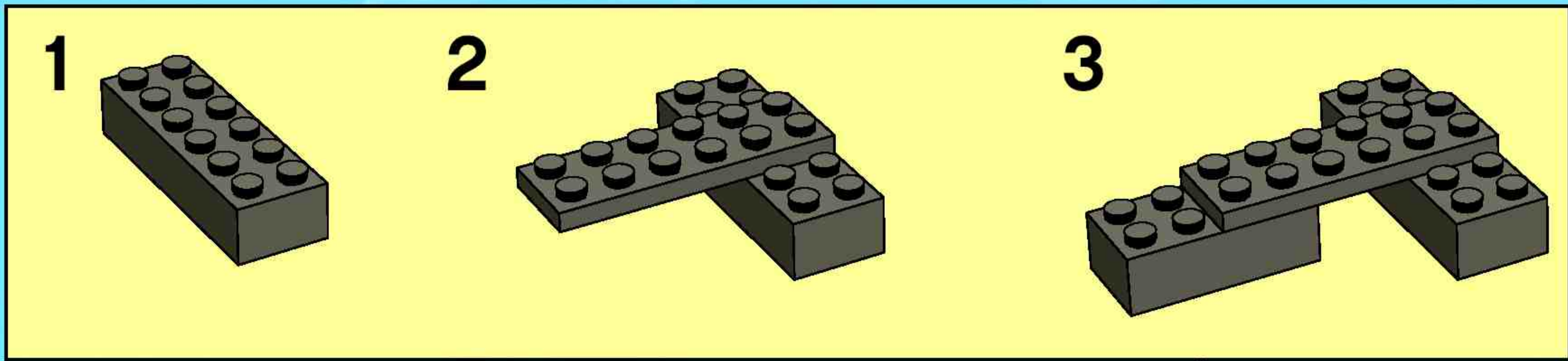

7

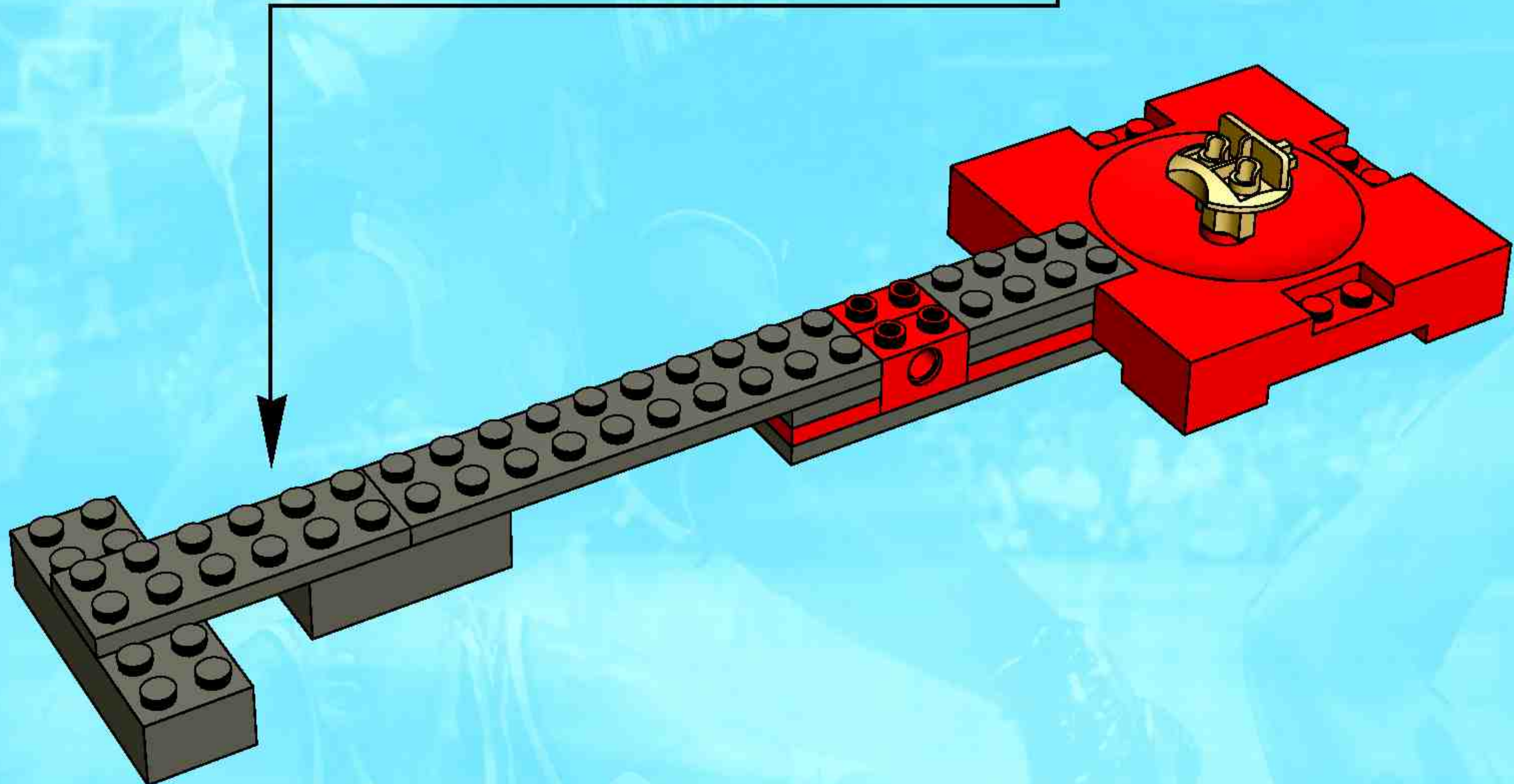

8

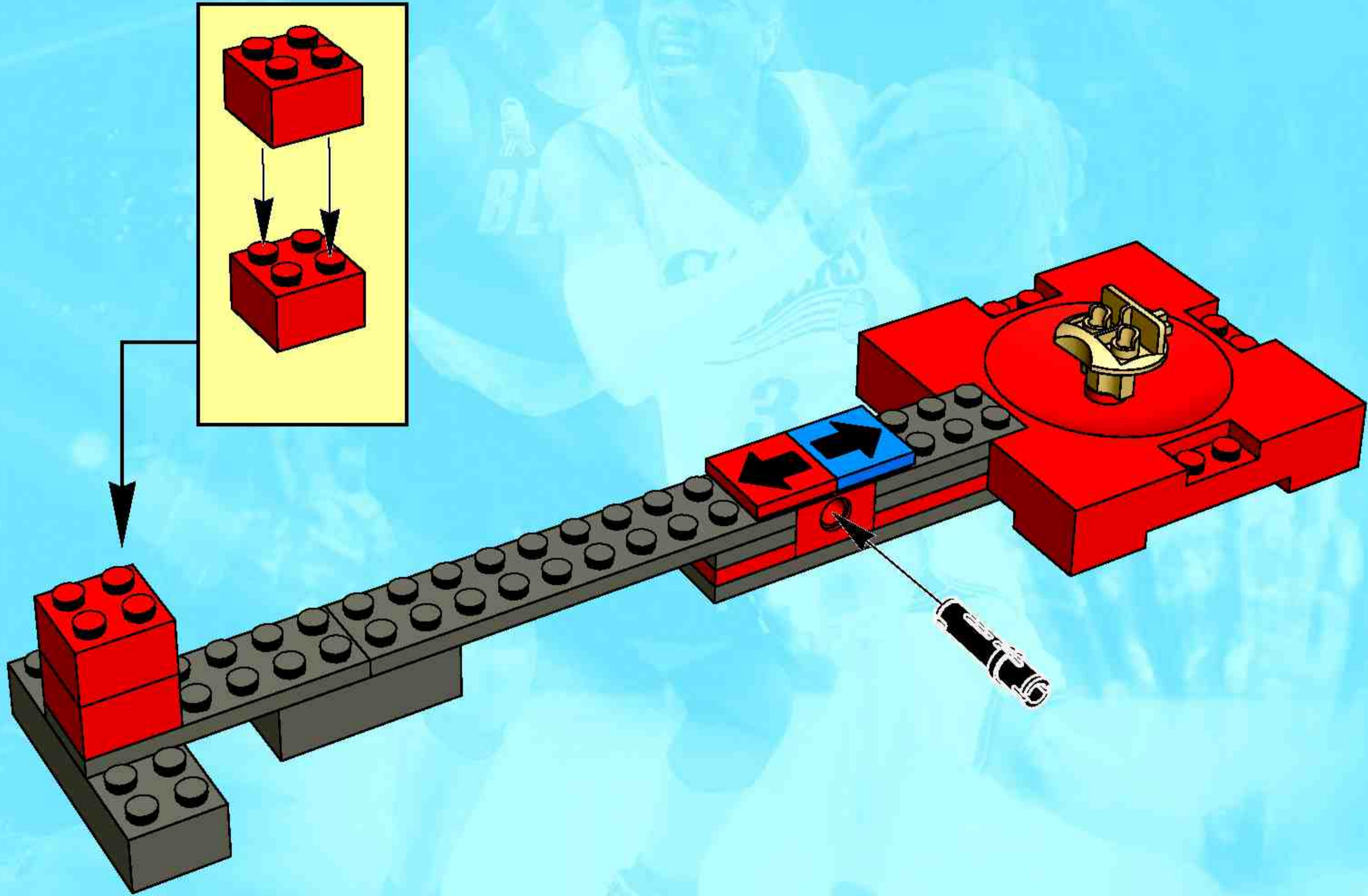

9

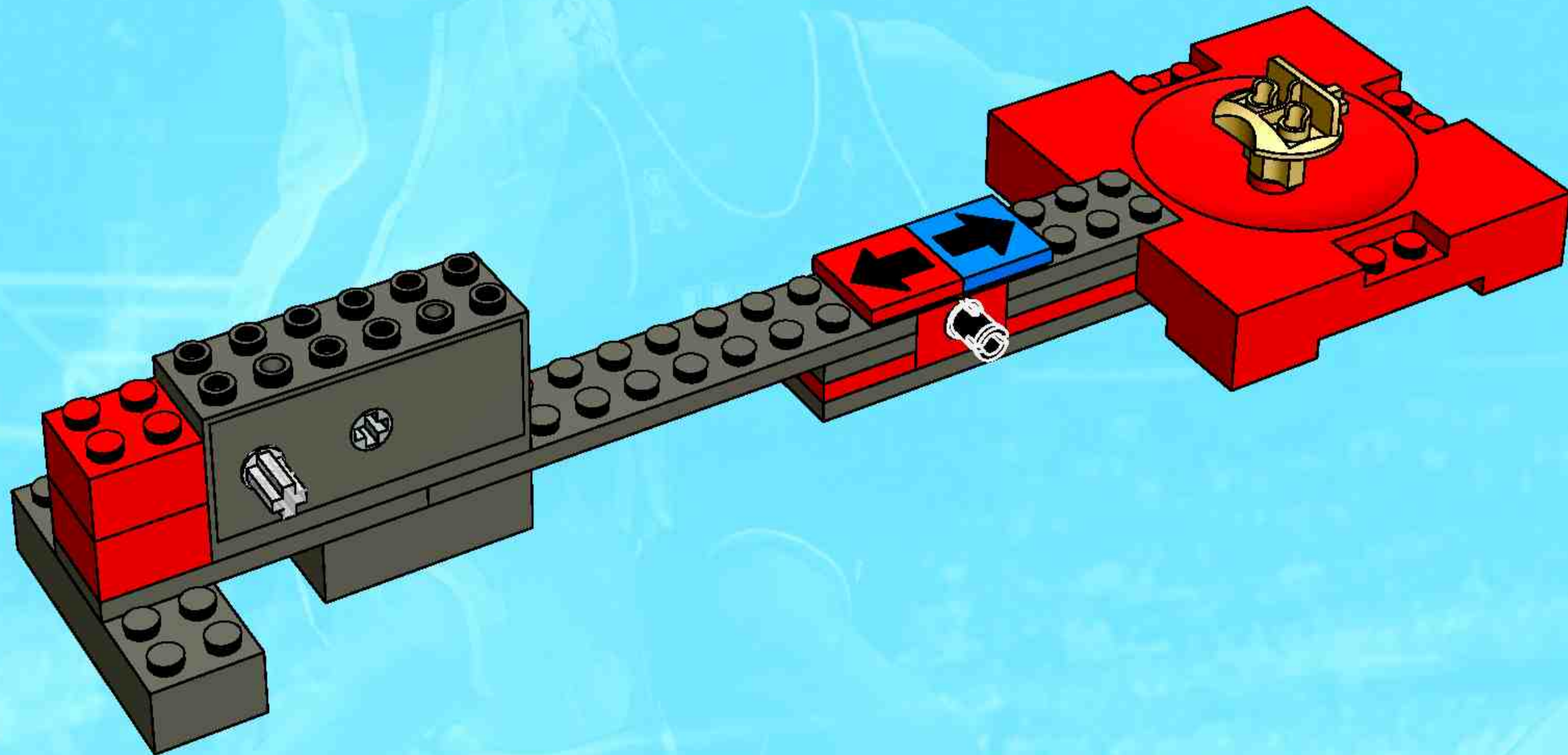

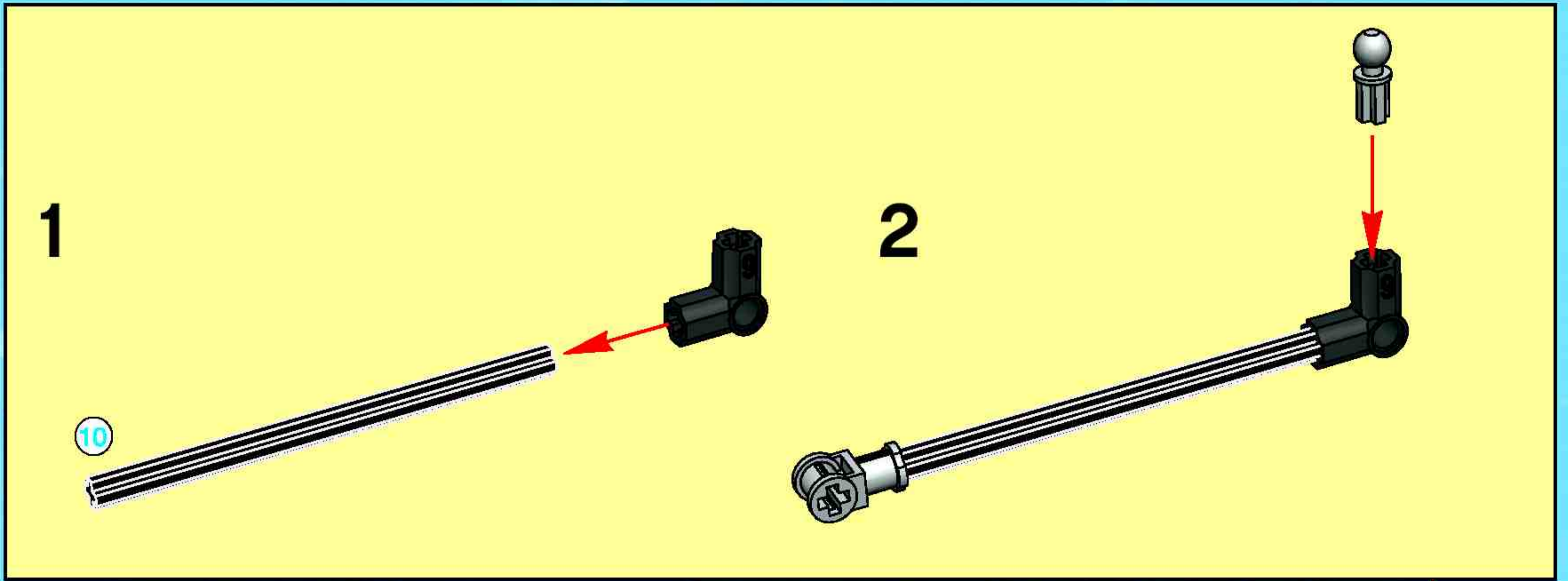

10

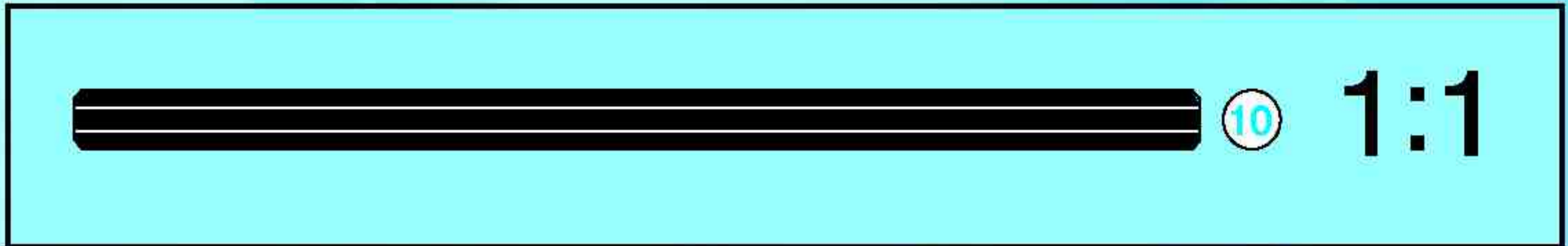
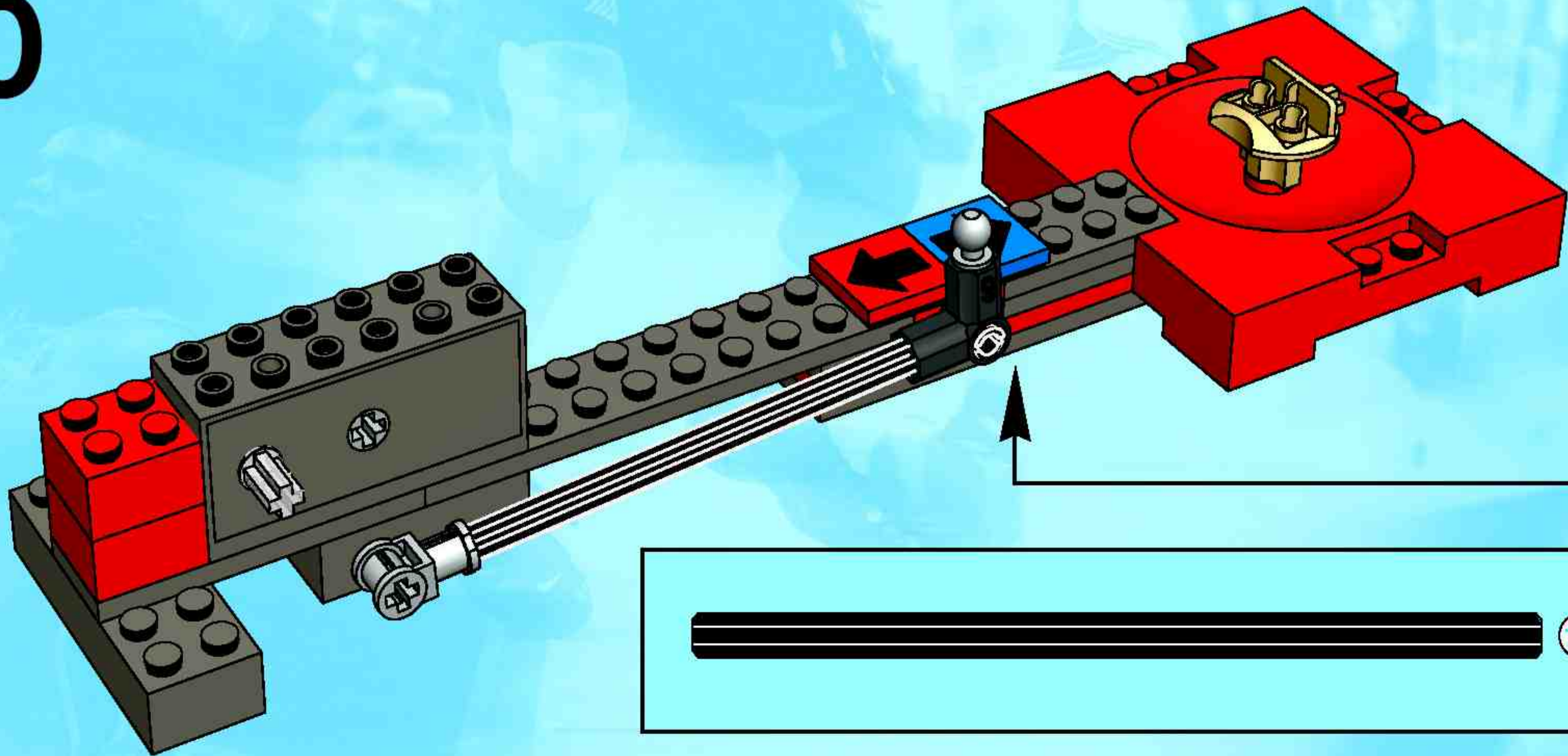

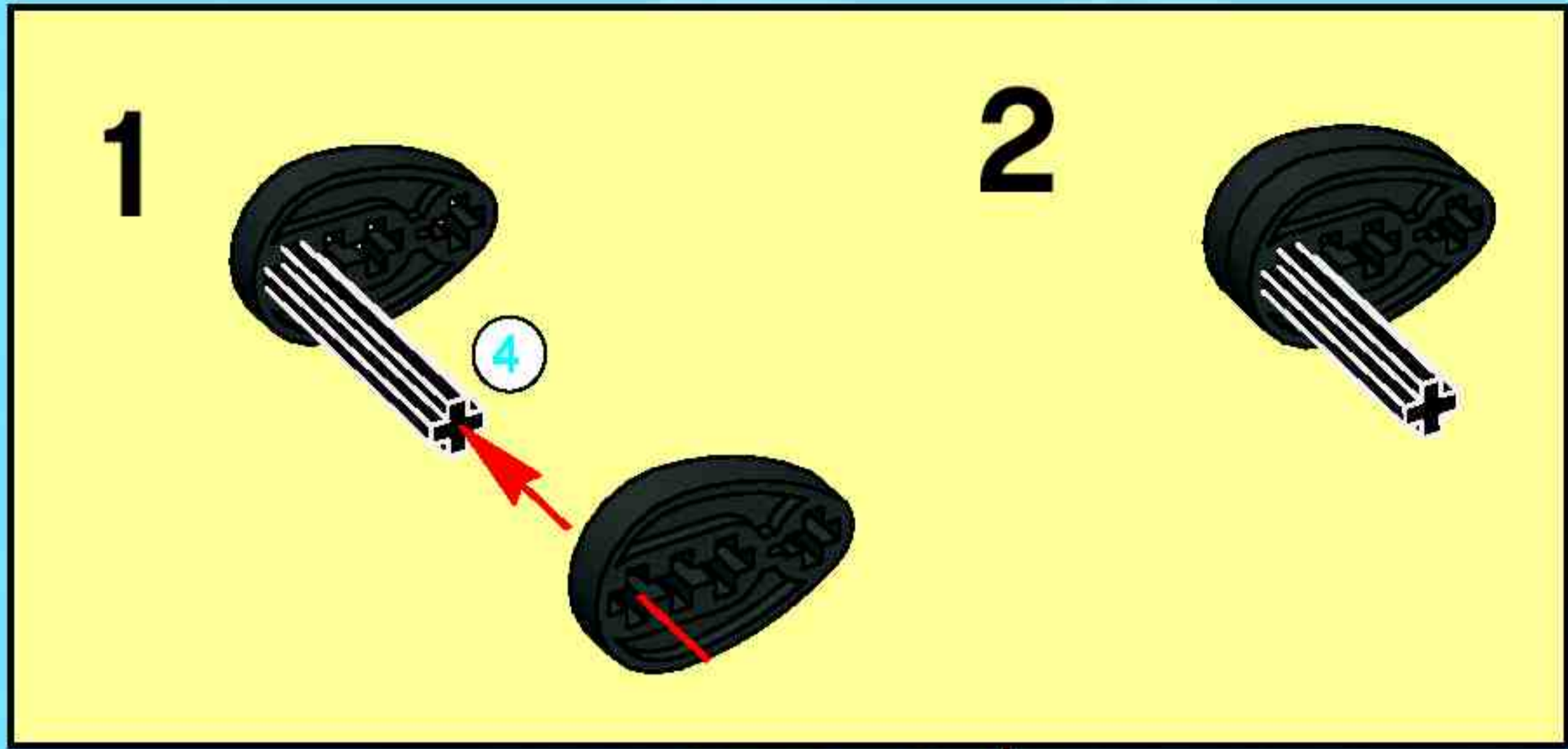

11

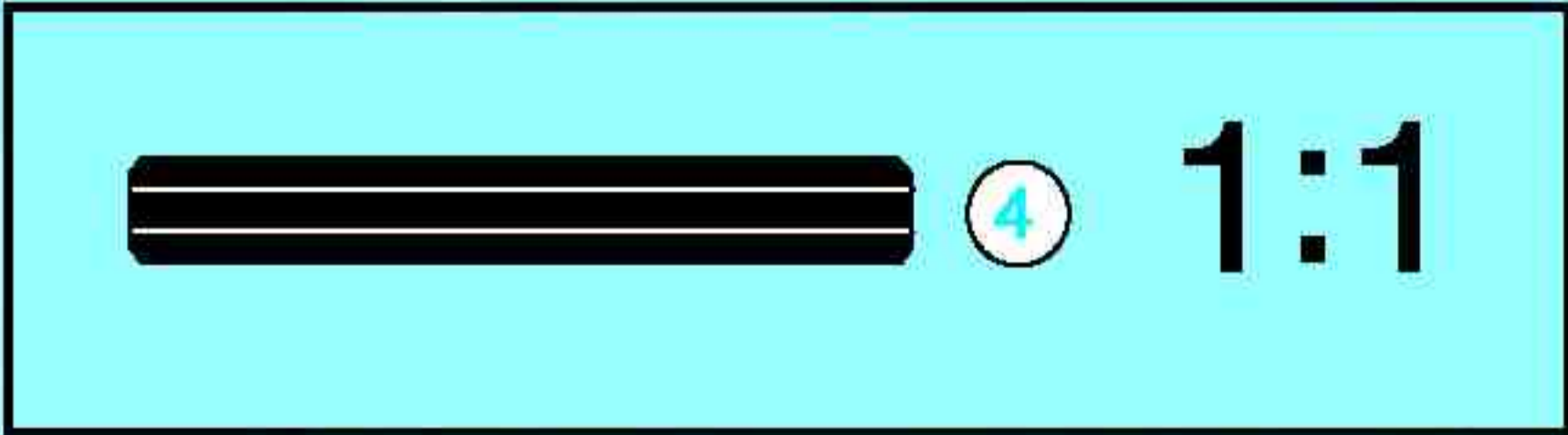
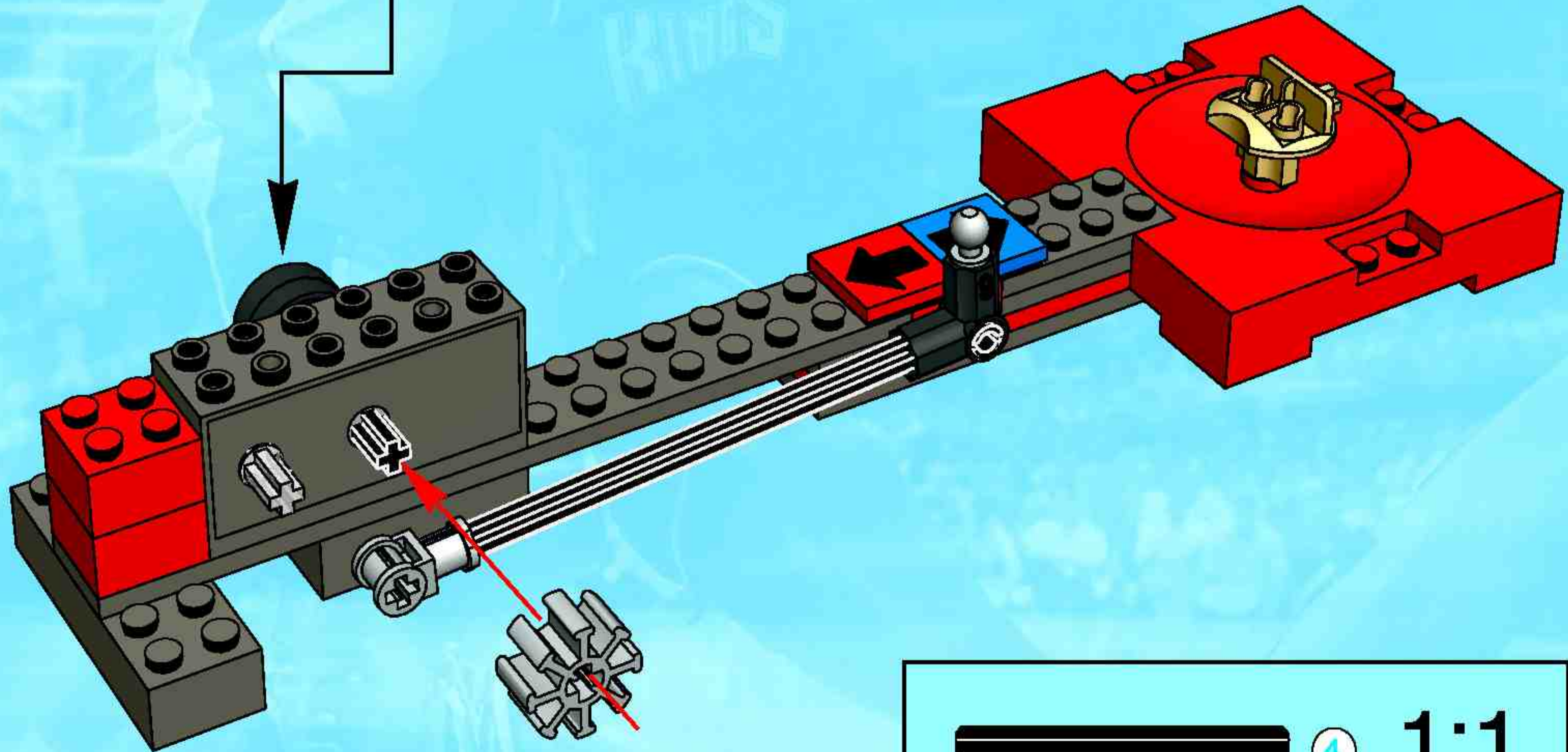

12

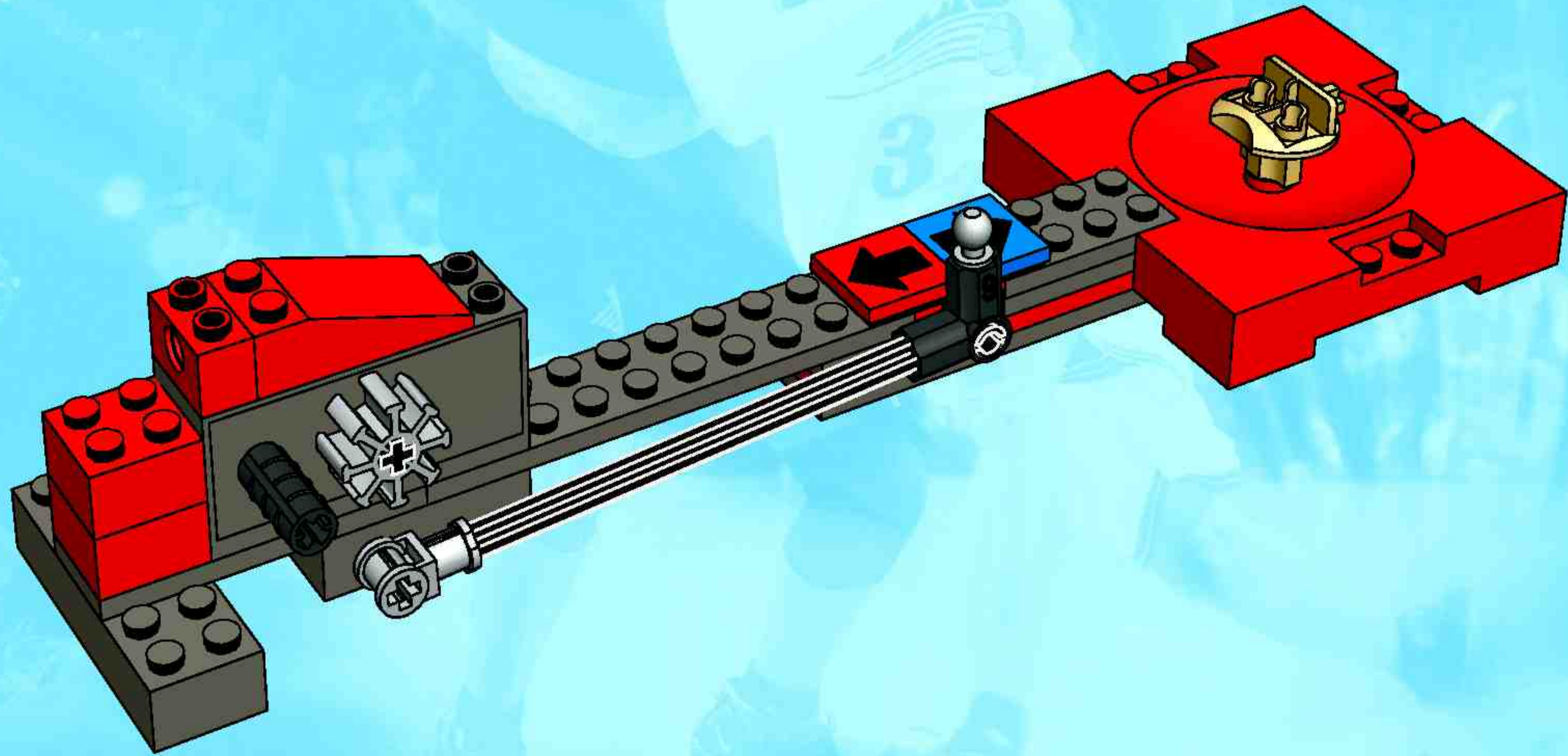

13

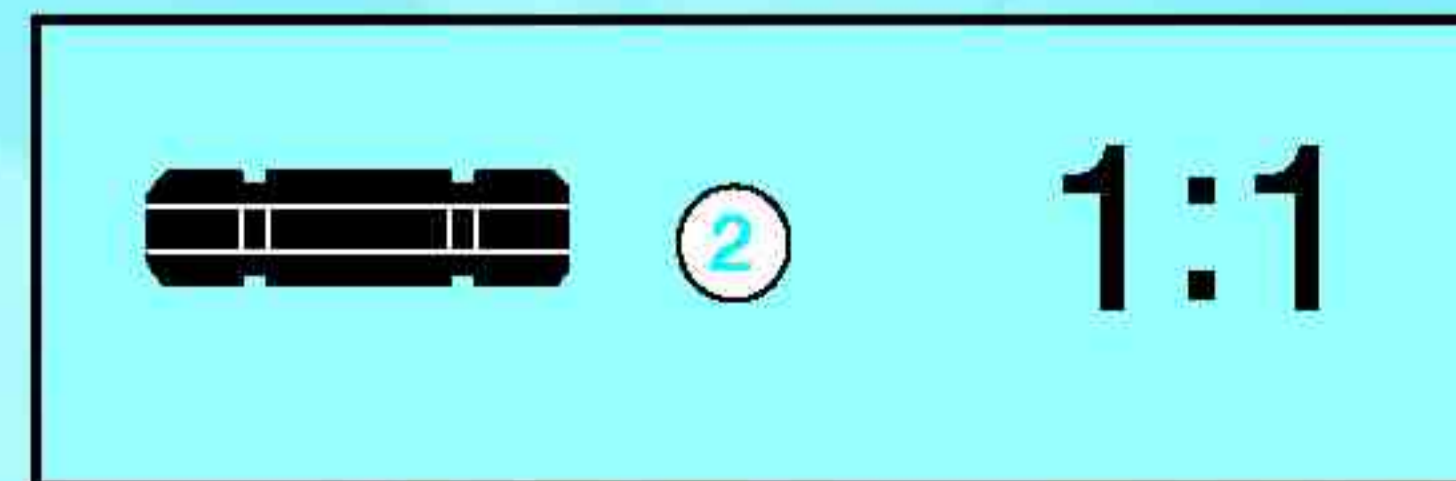
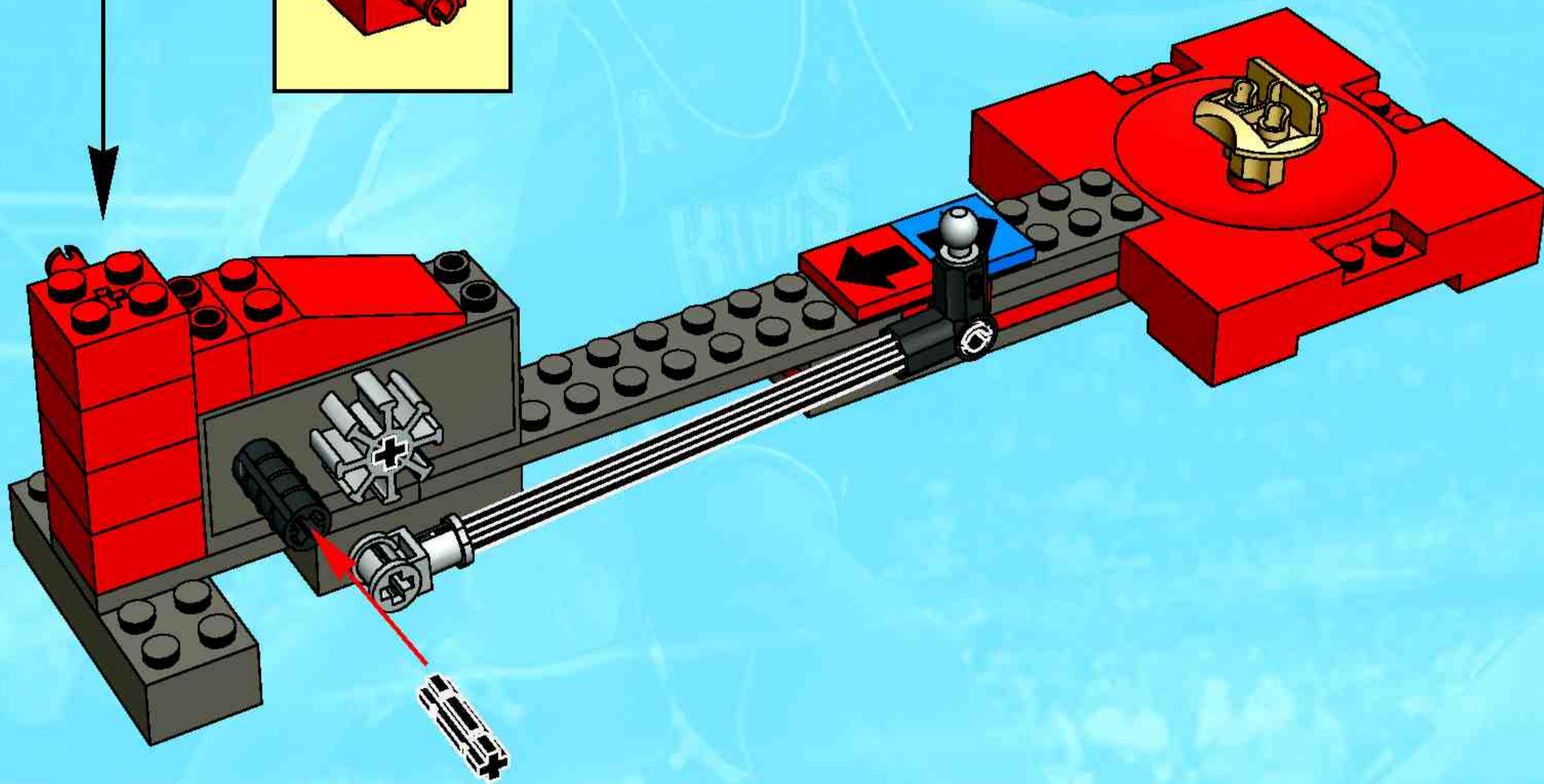
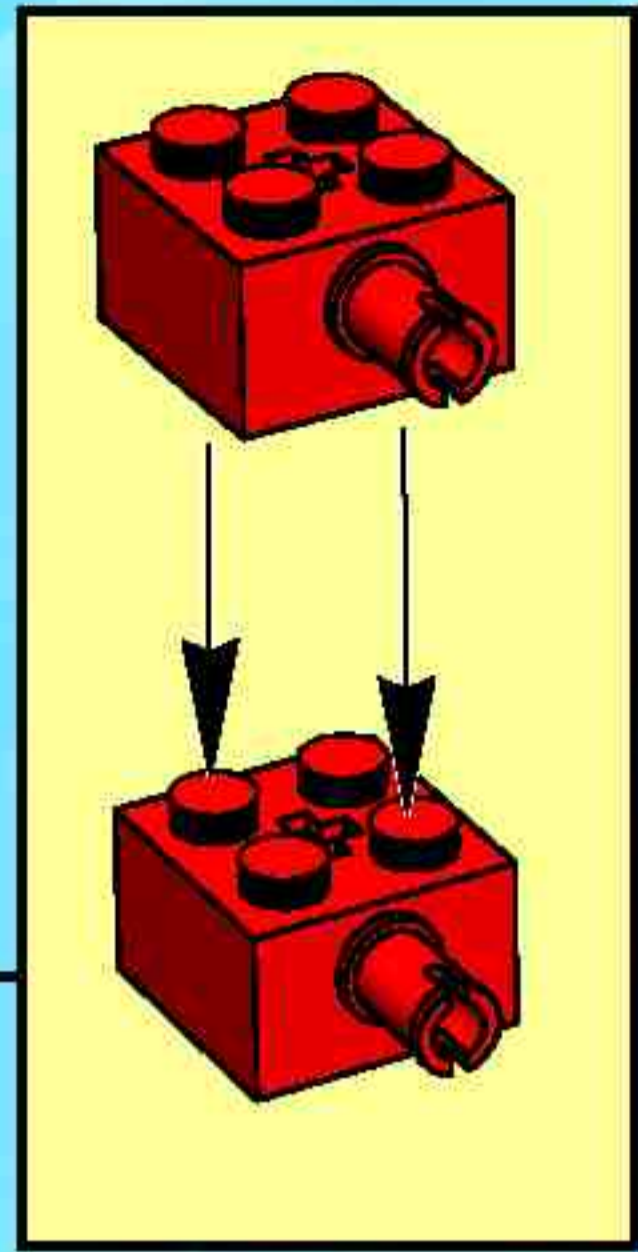

14

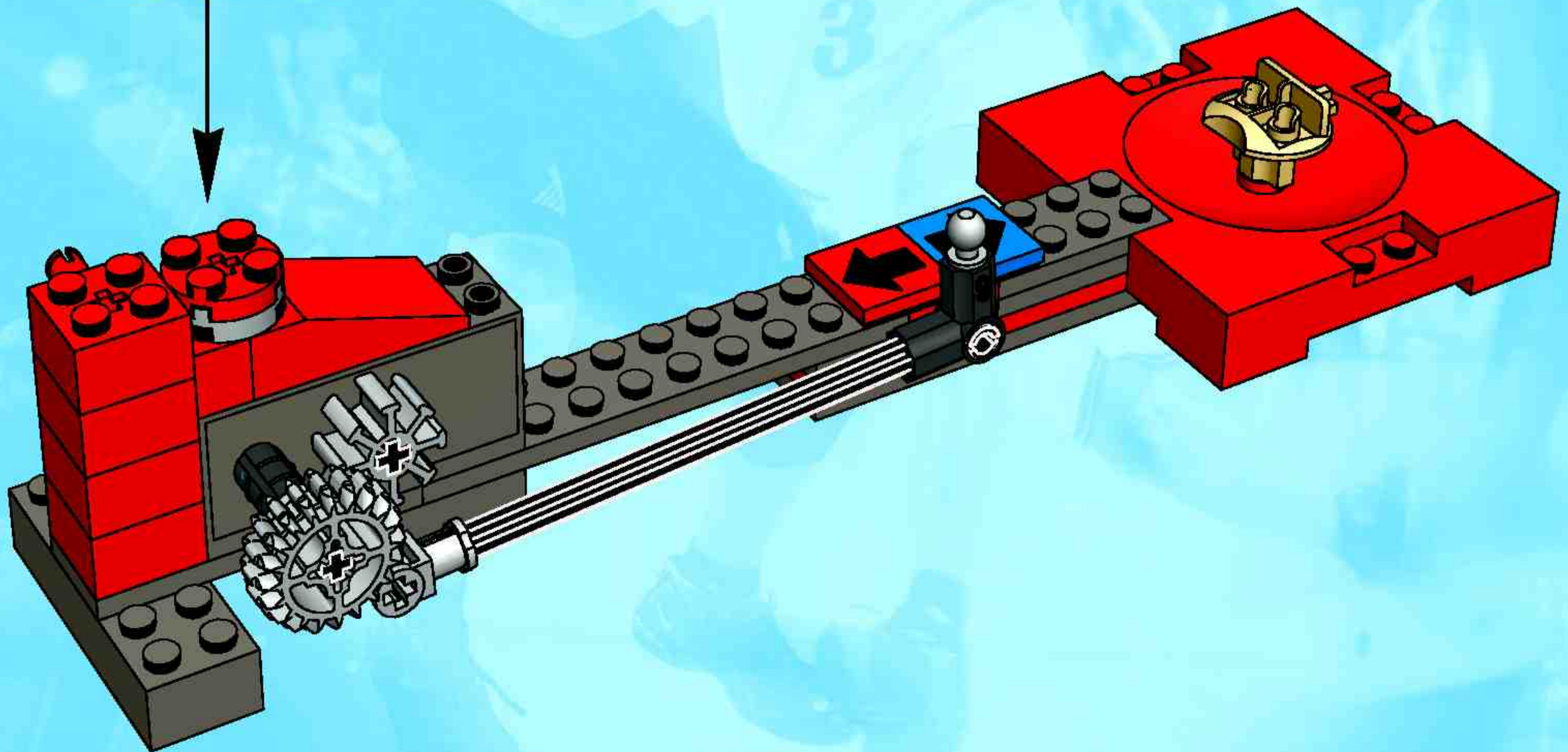
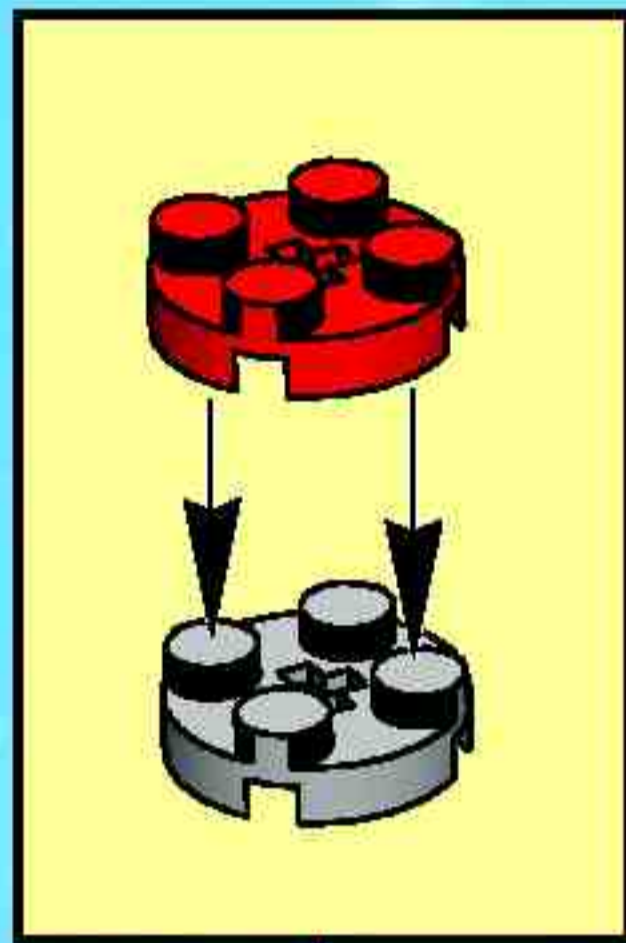

15

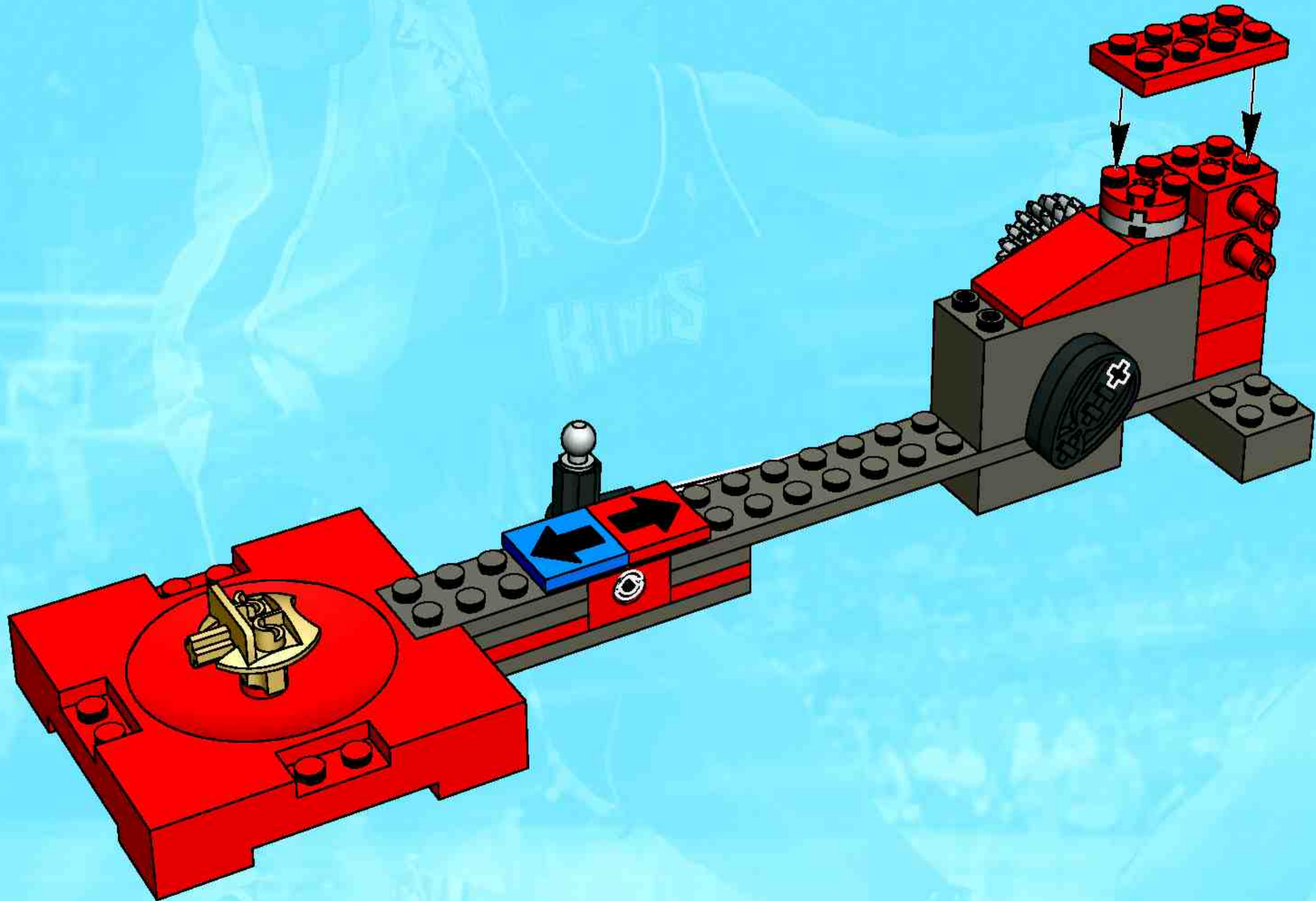

16

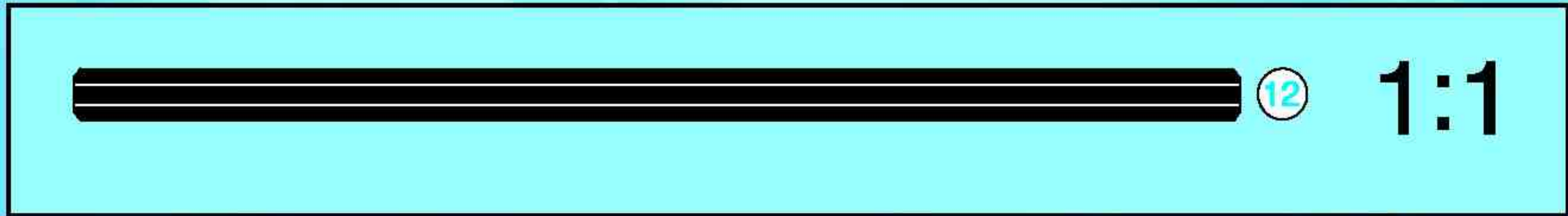
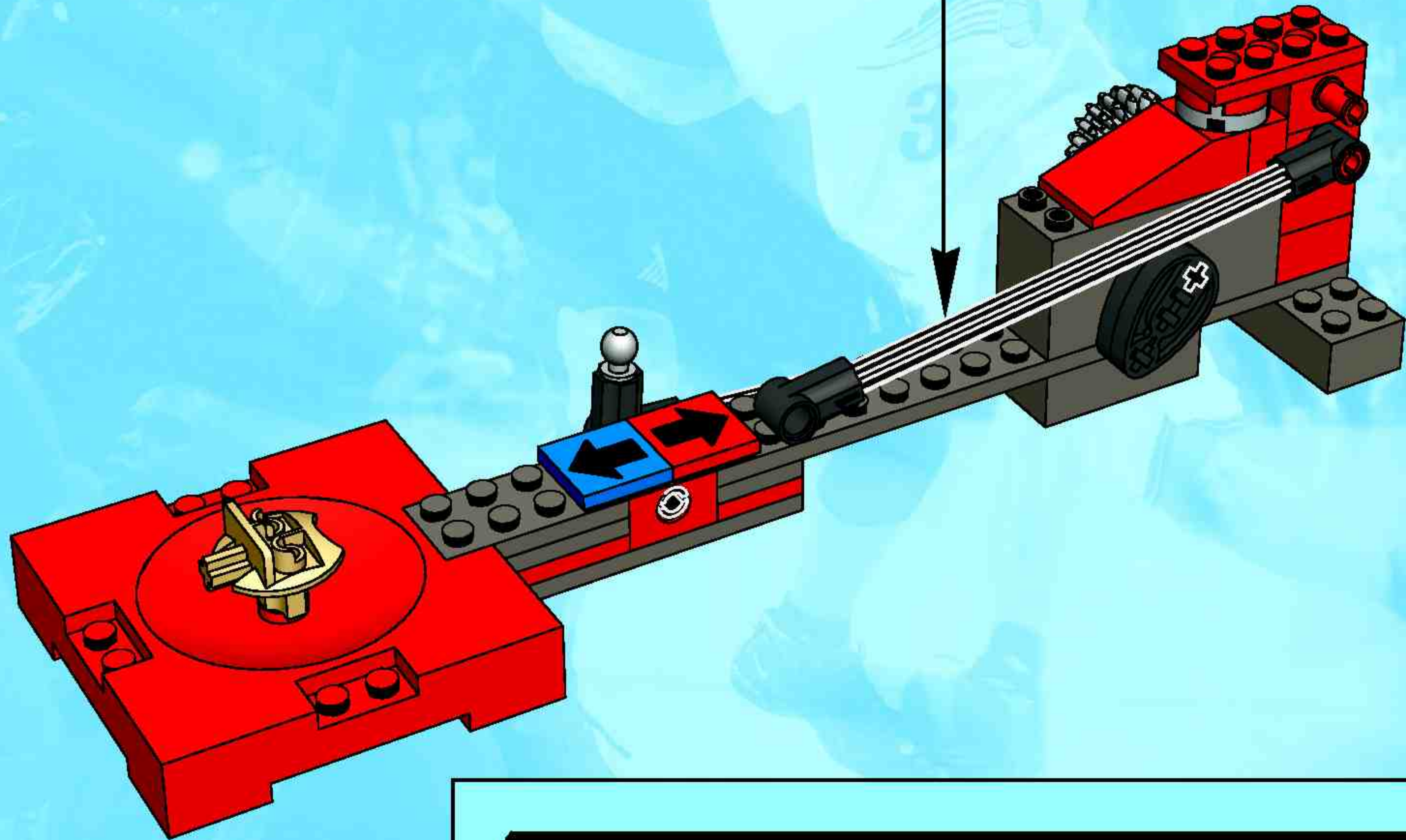
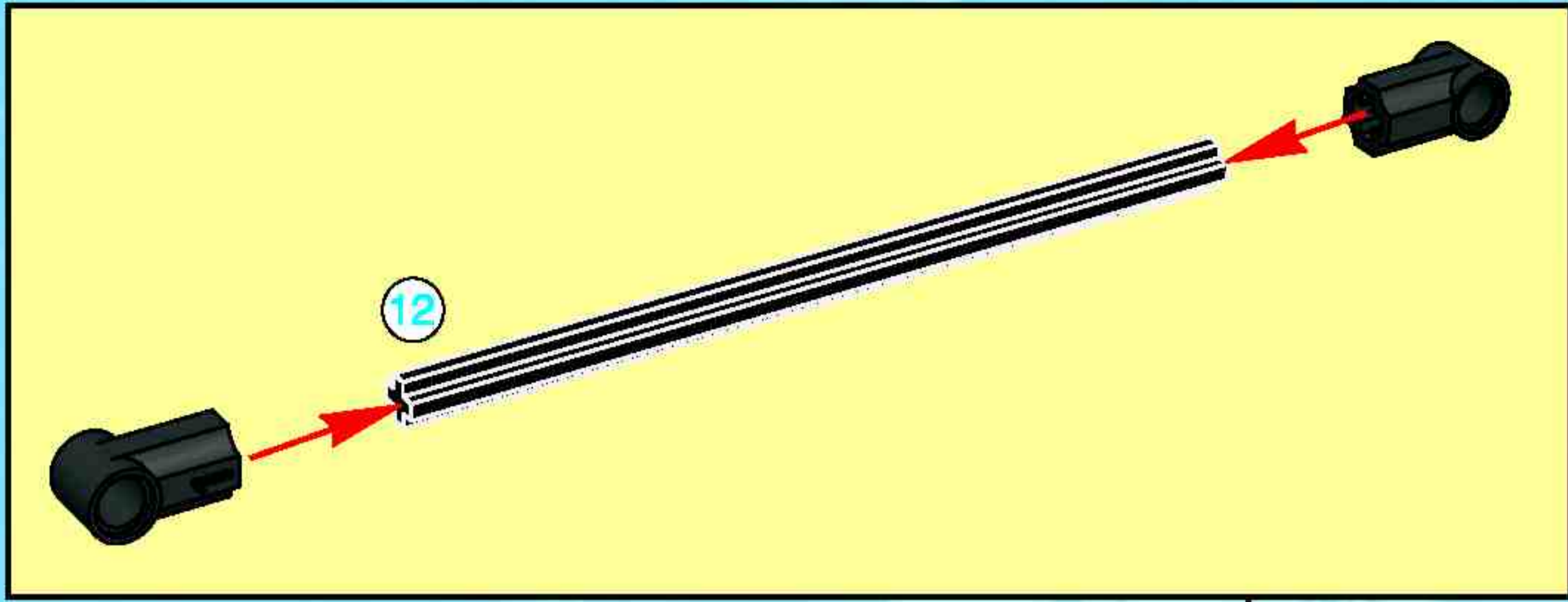

17

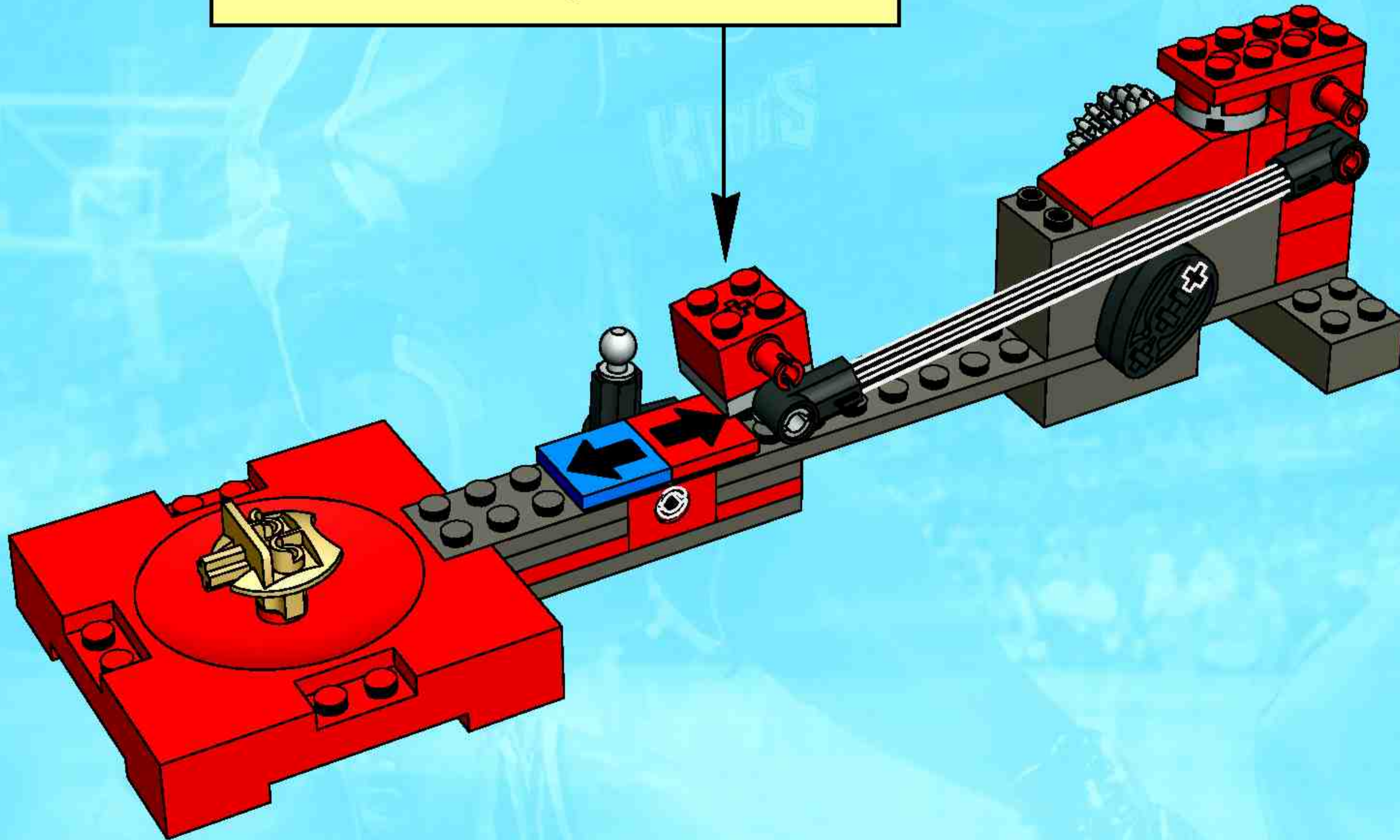
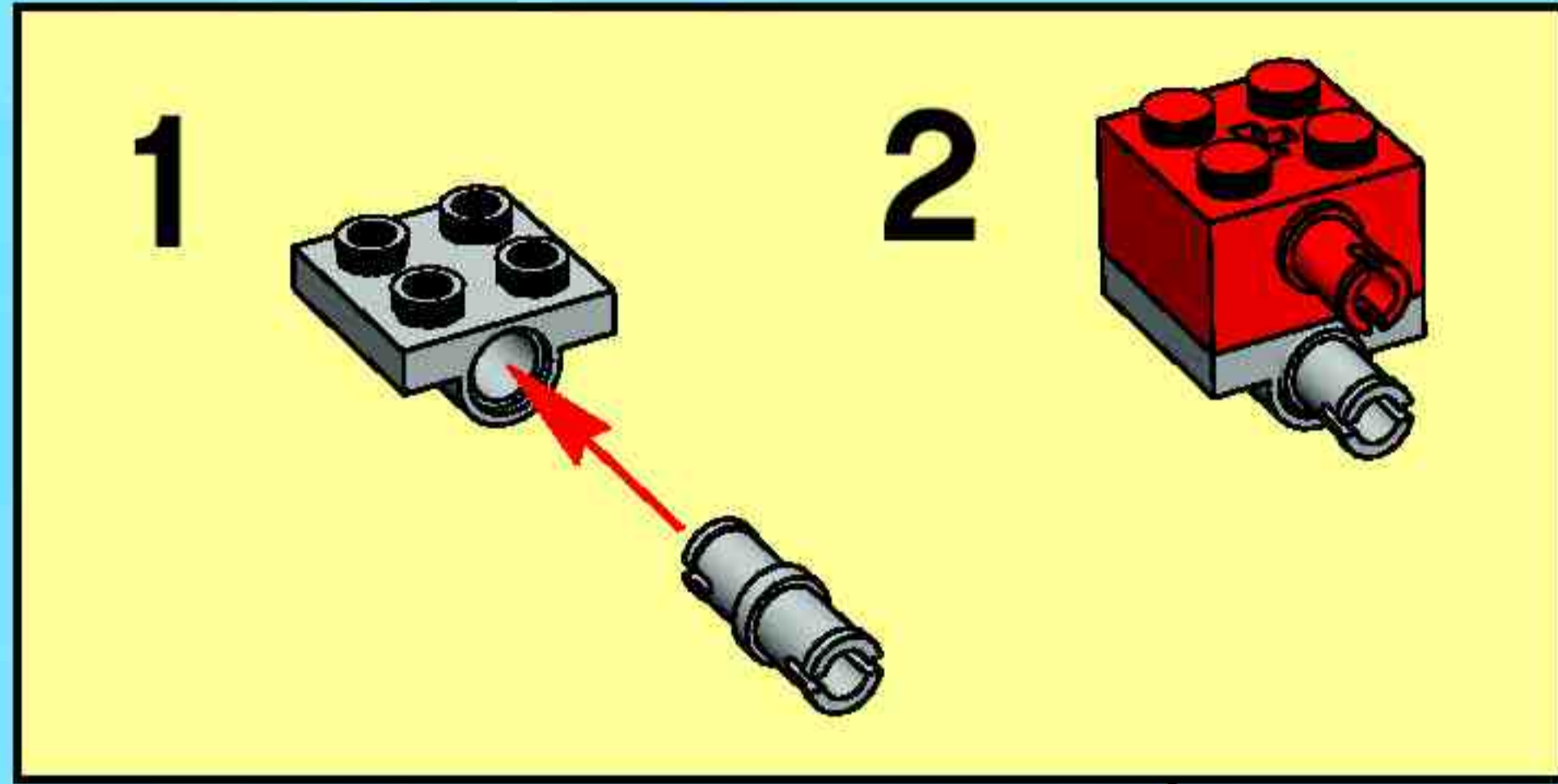

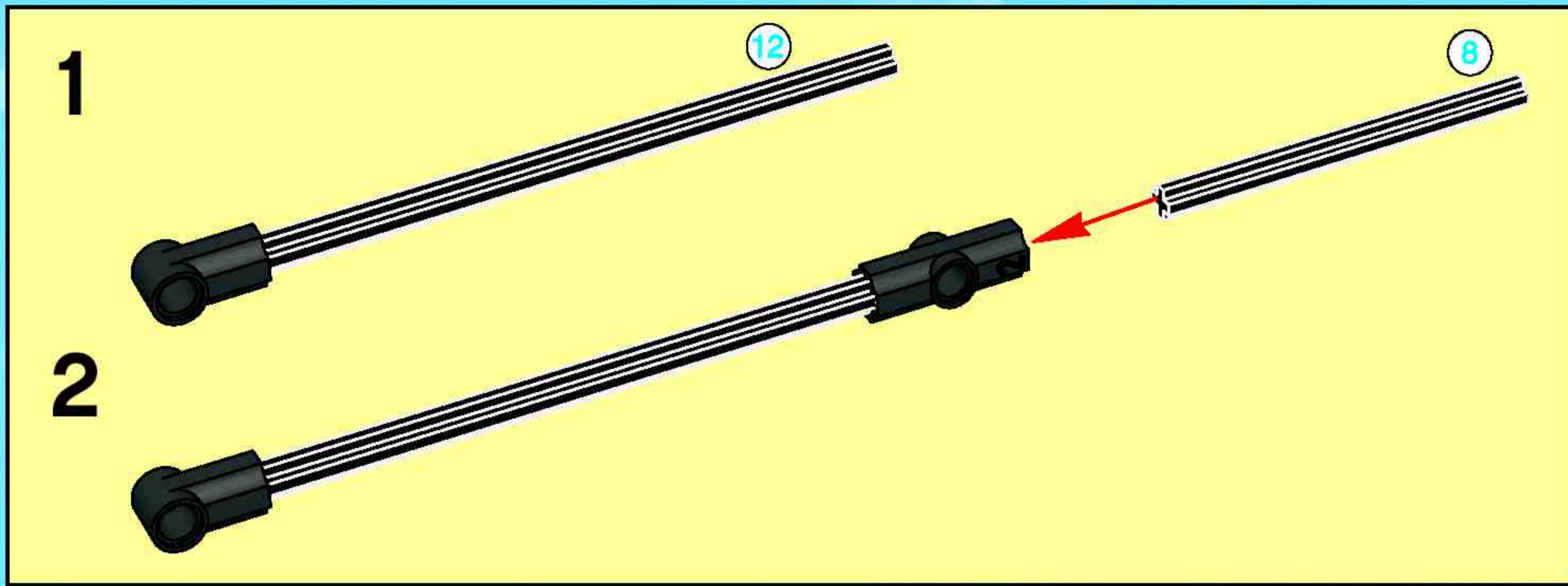

18

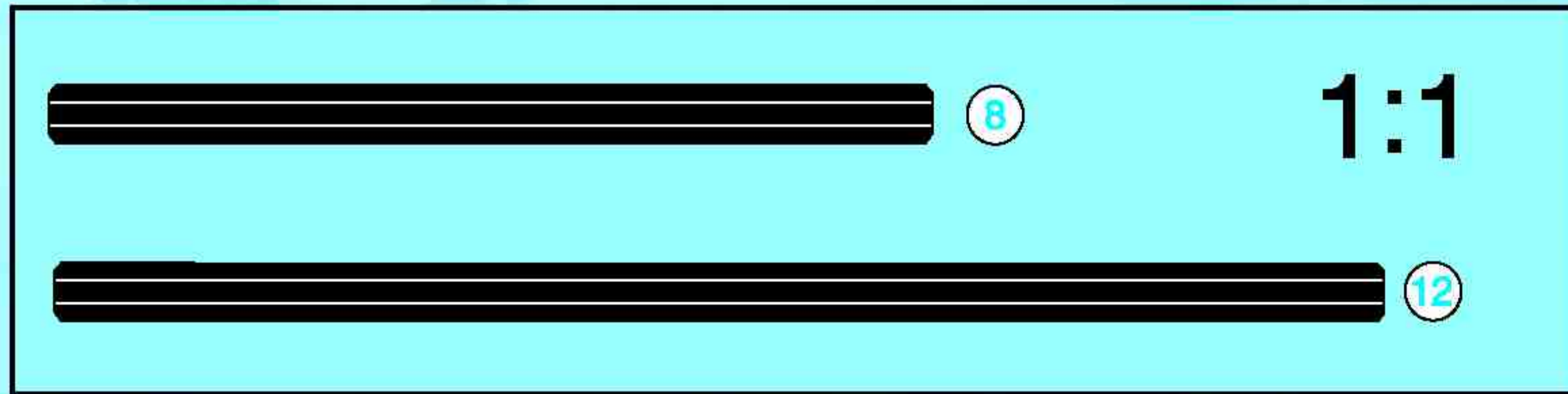
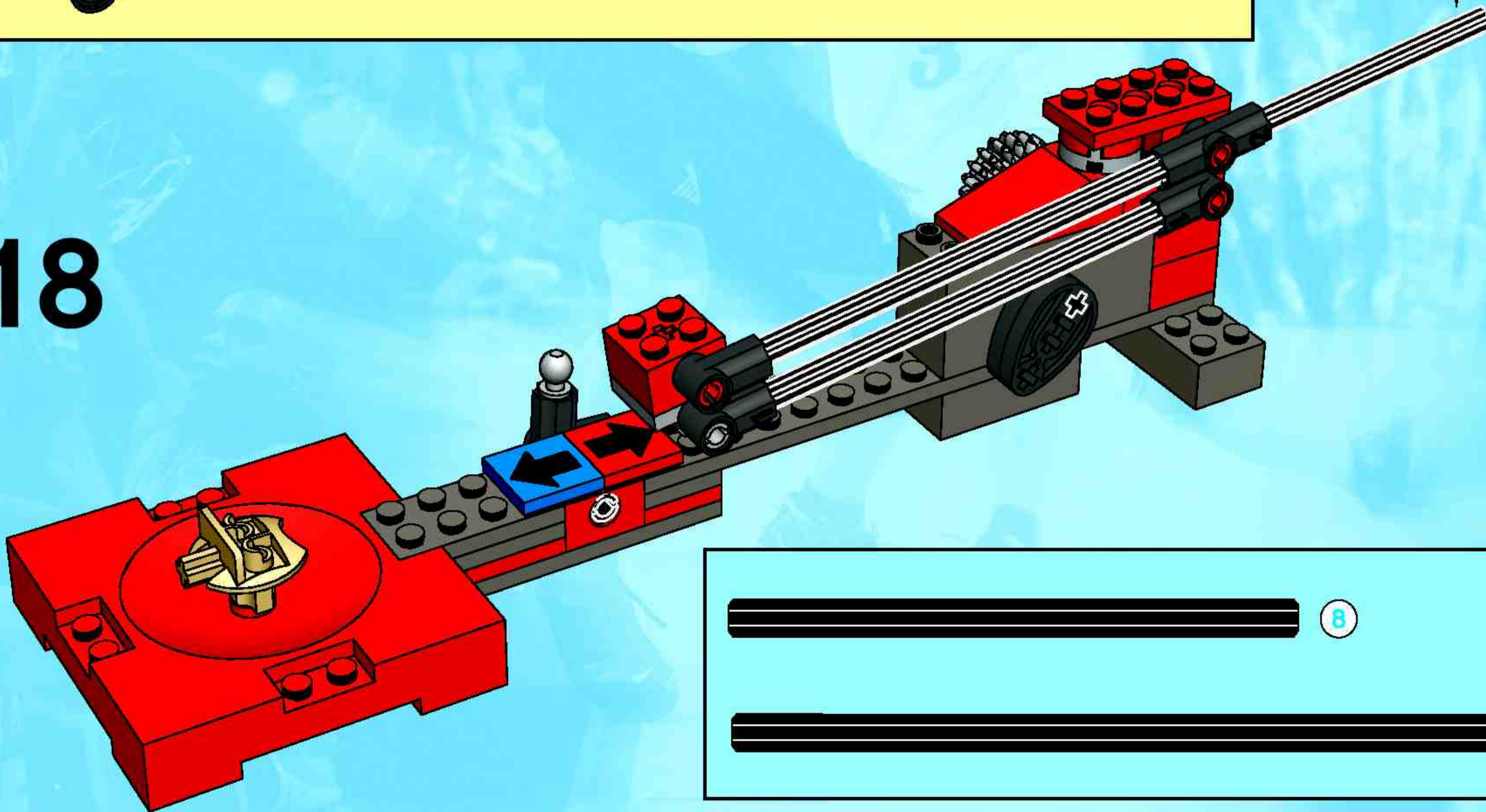

19

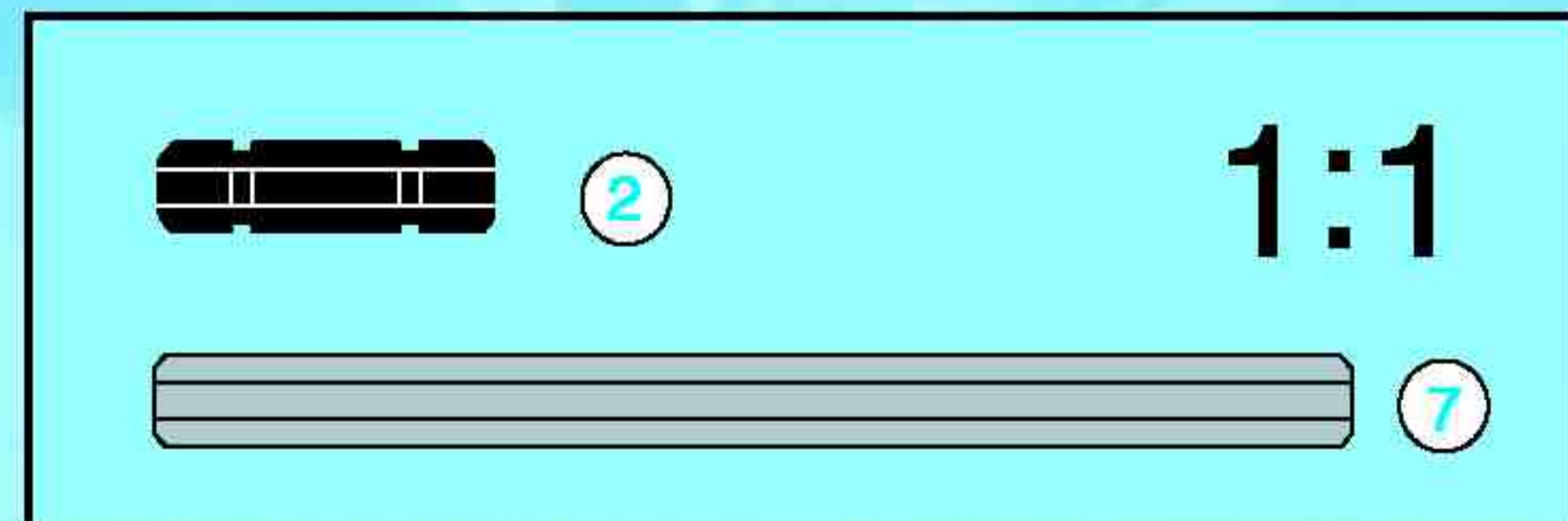
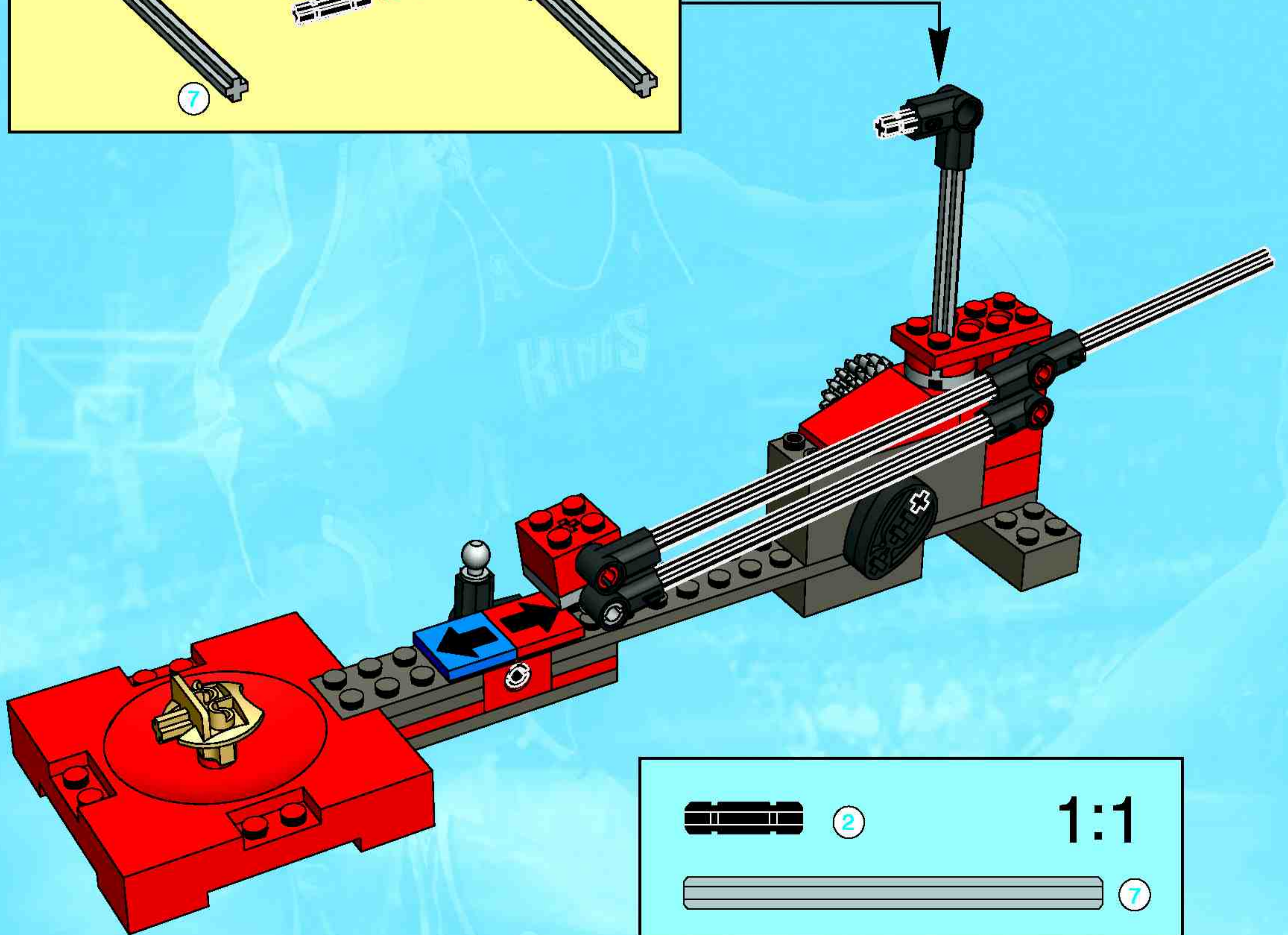
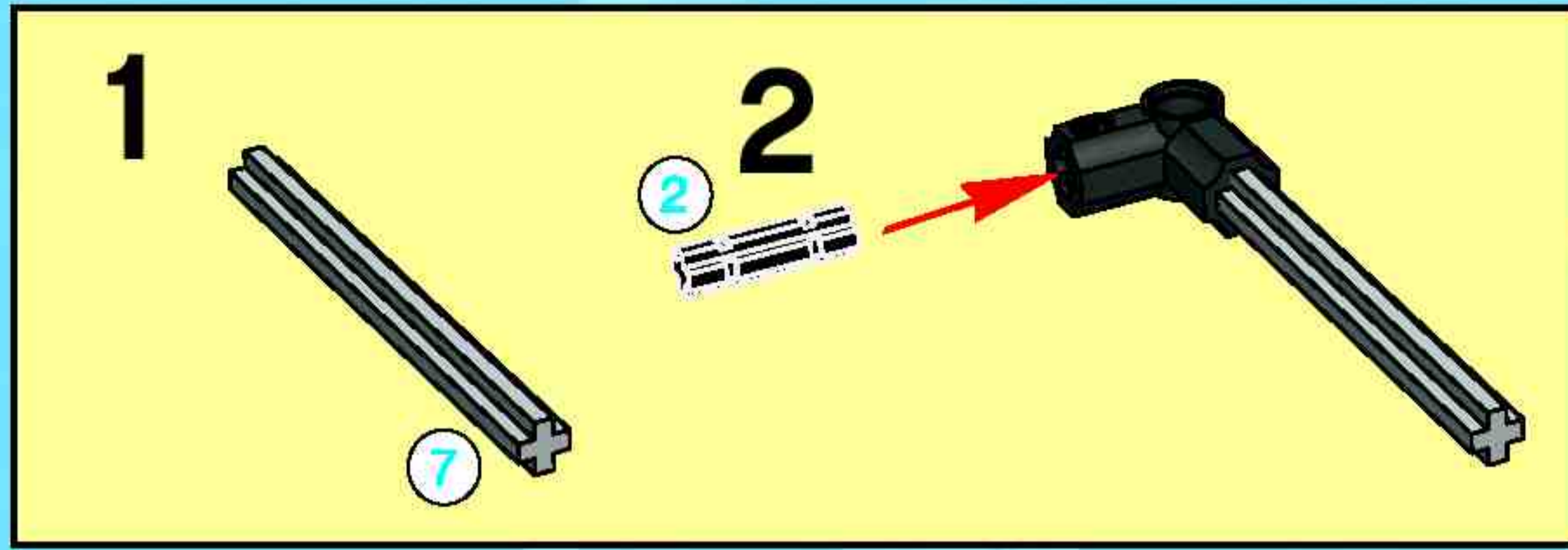

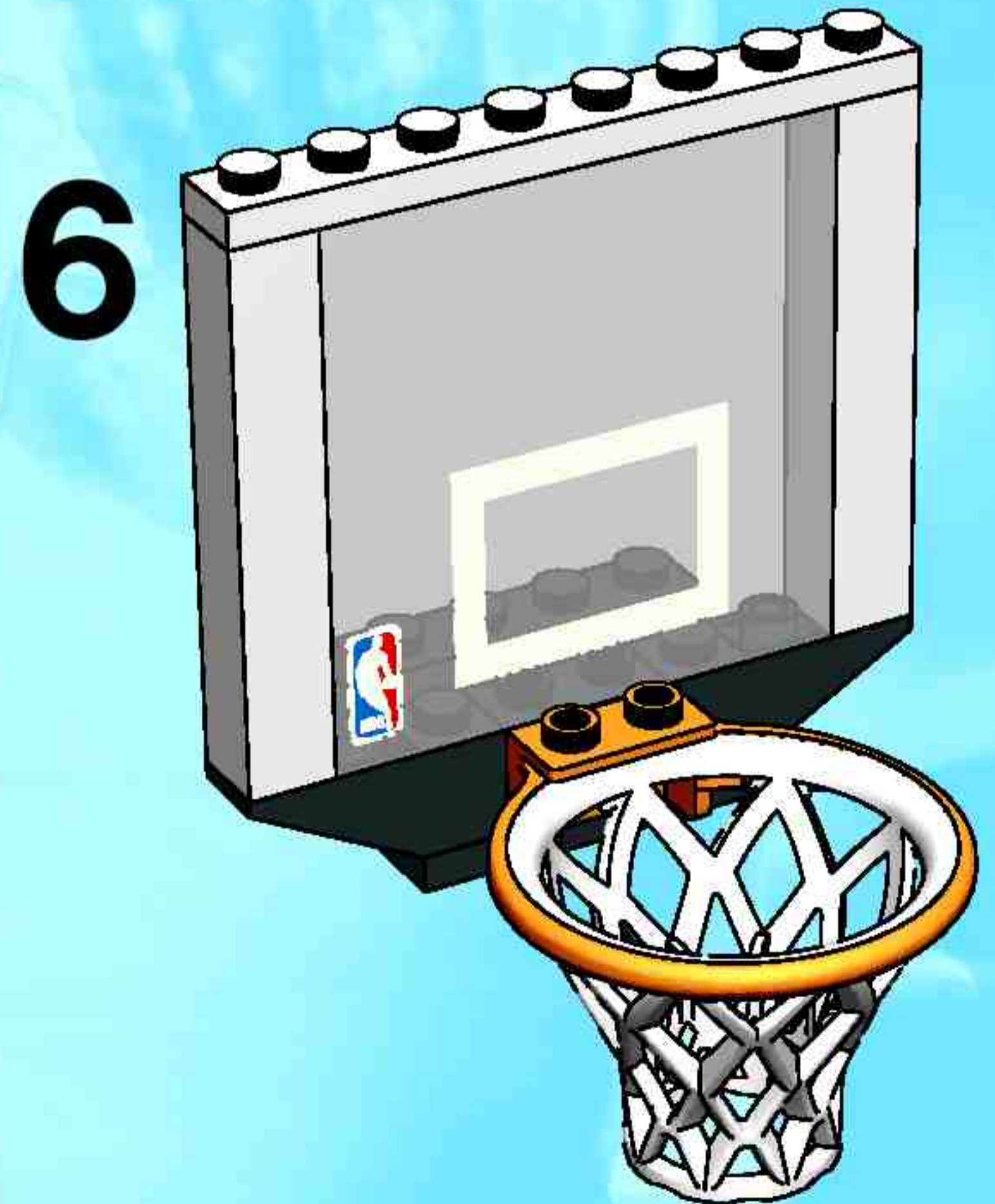
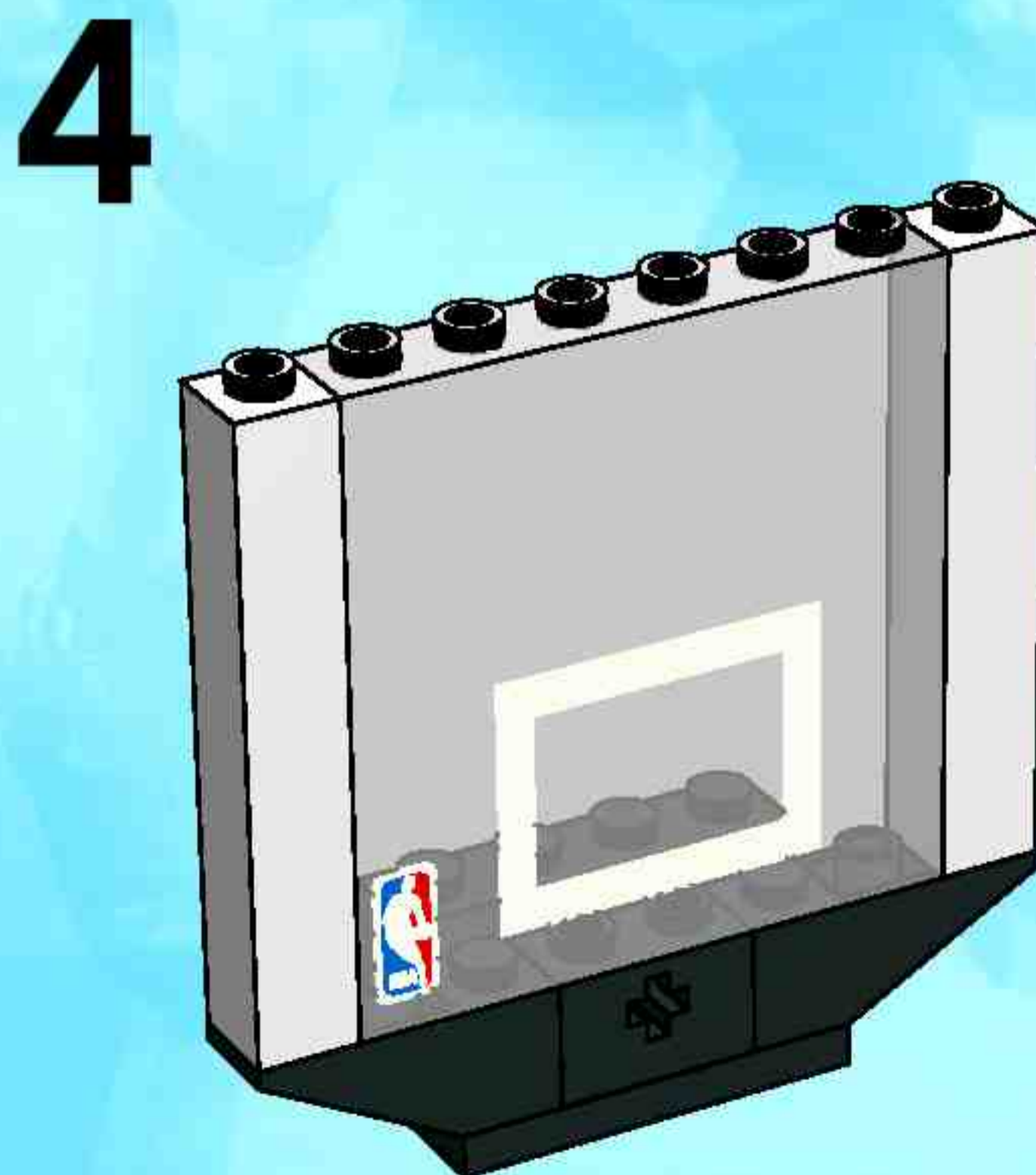
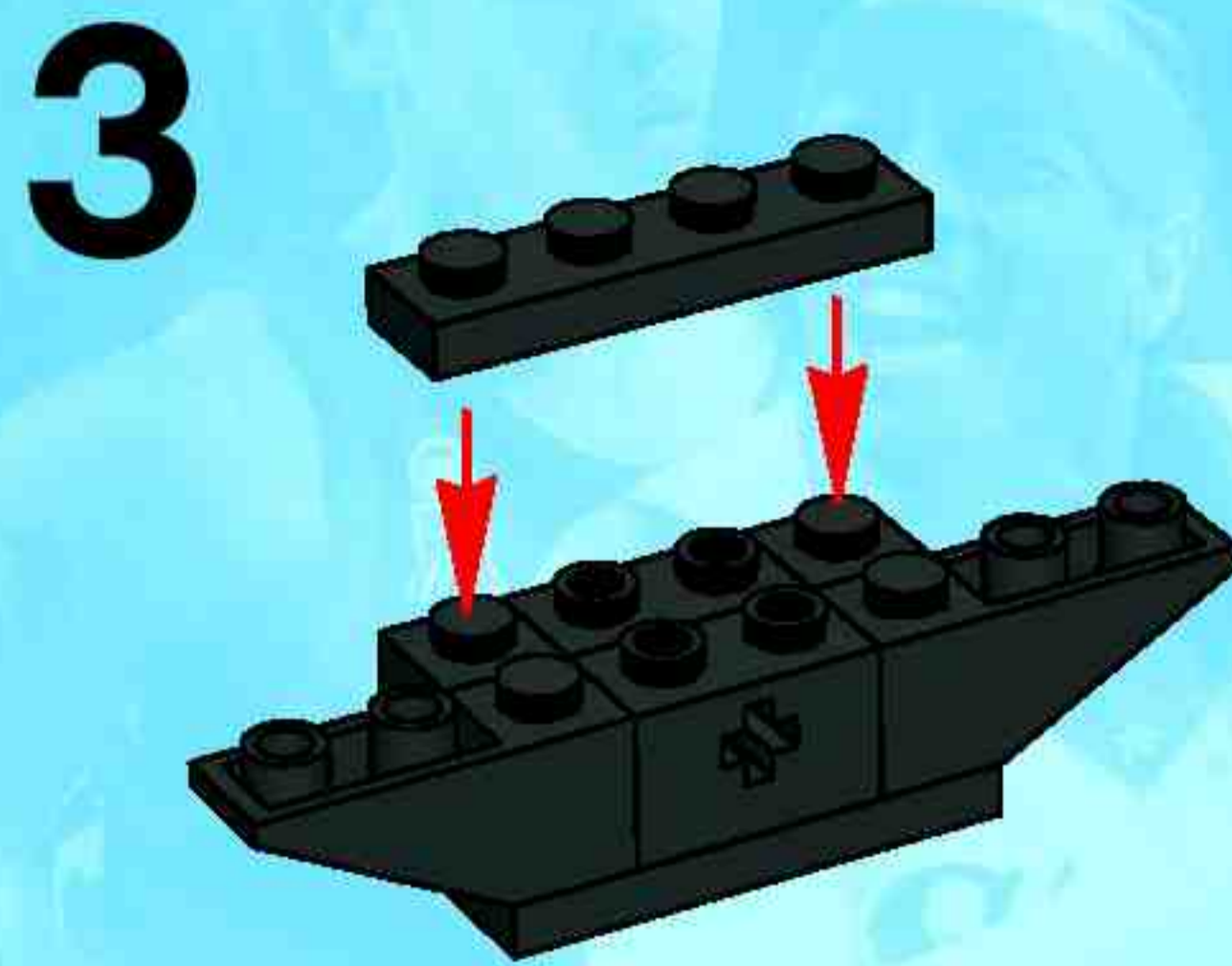
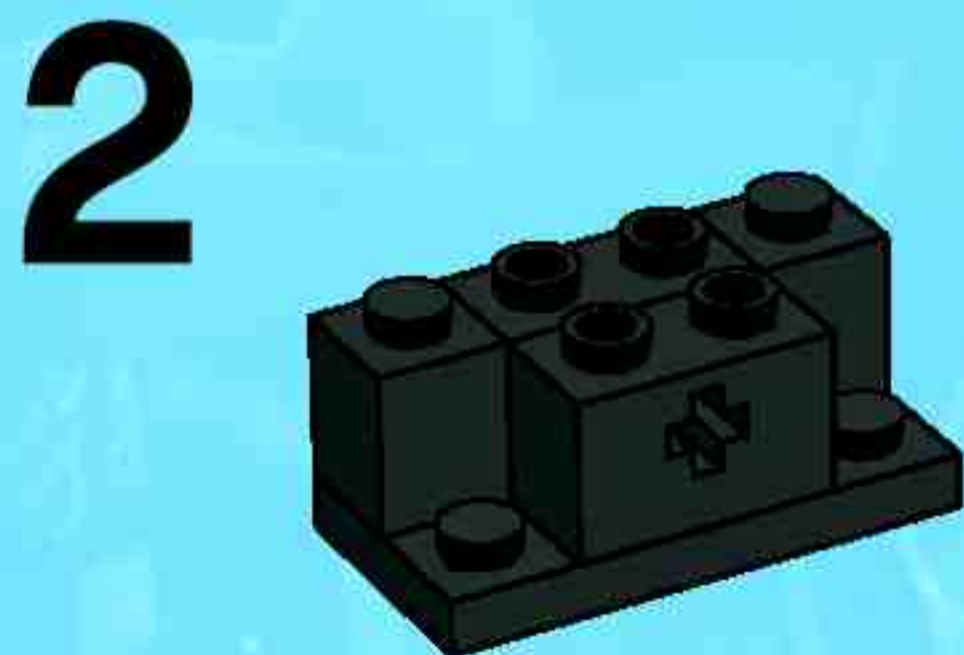
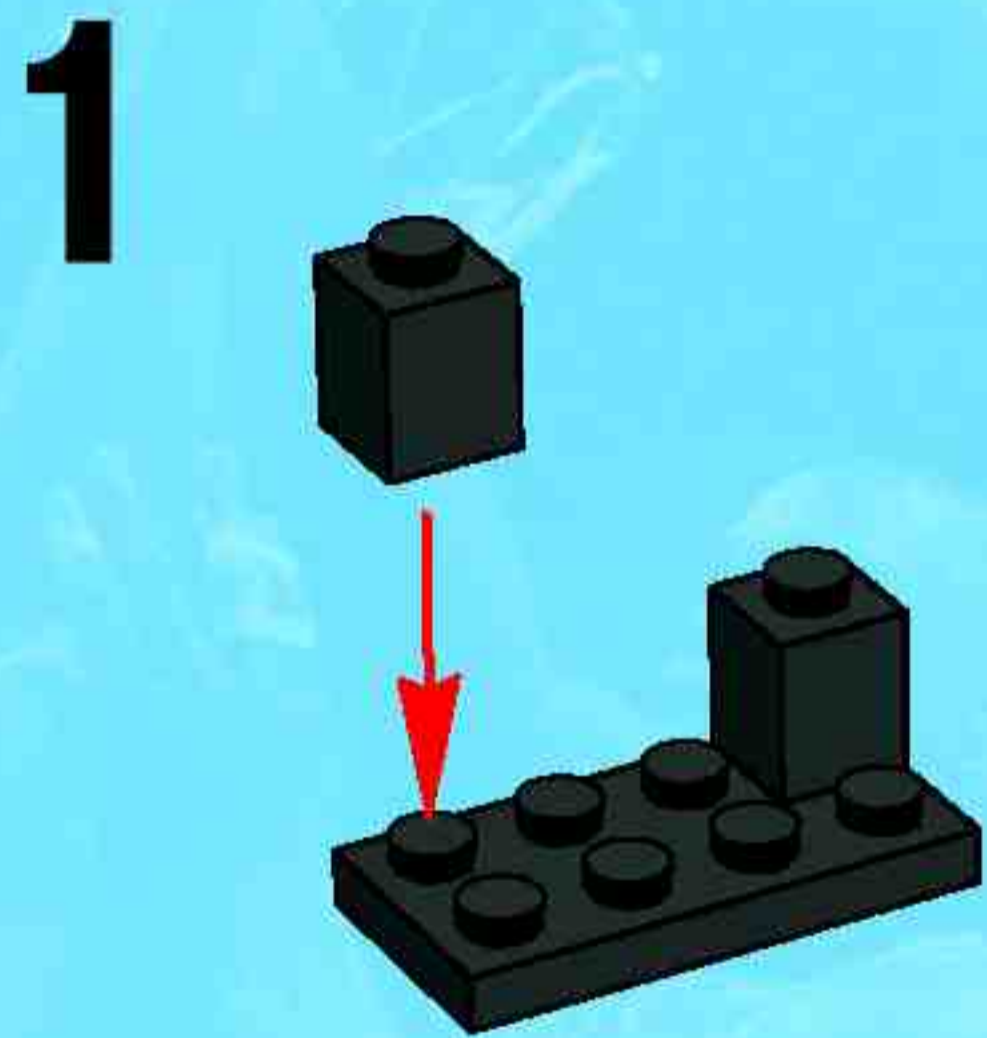
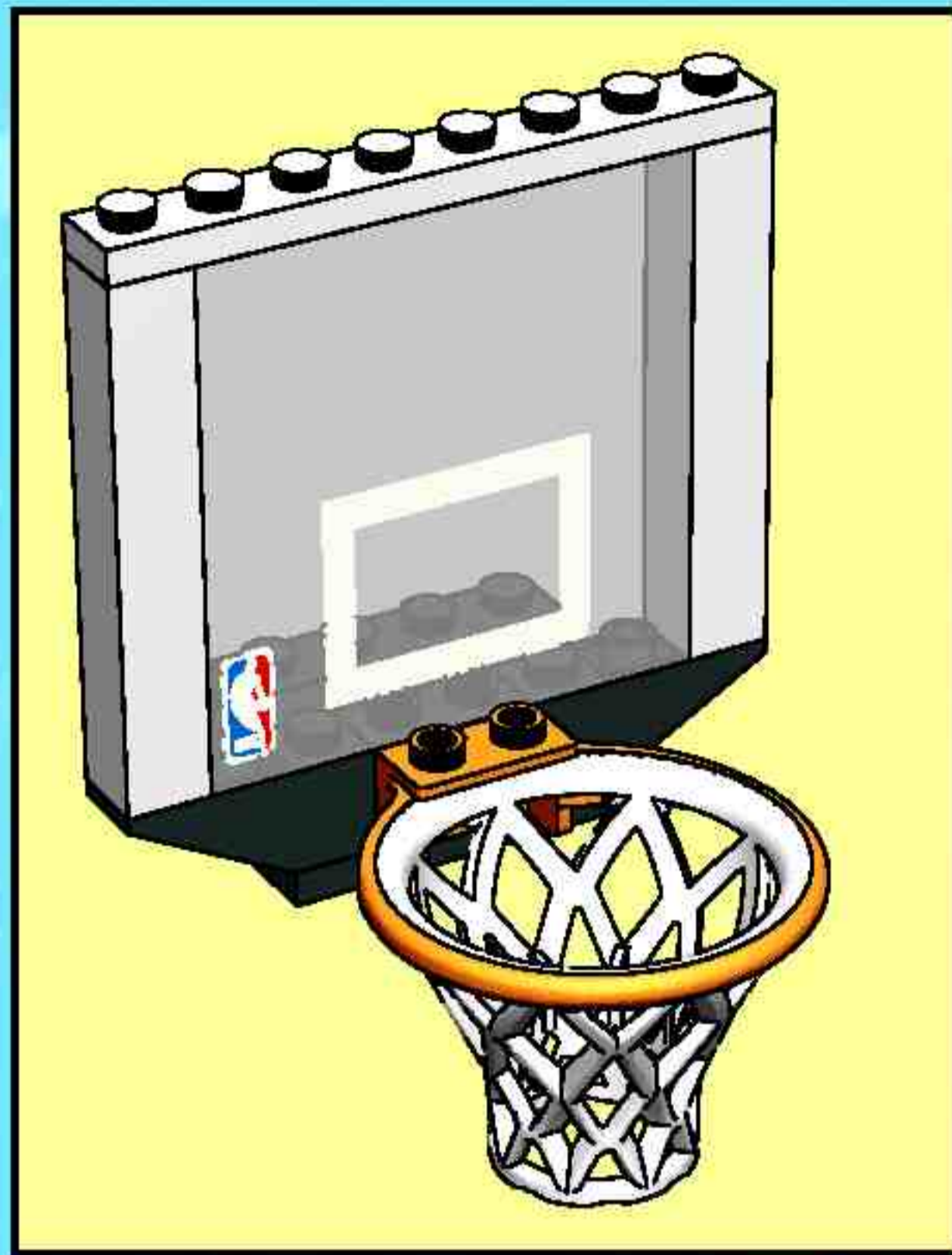

20

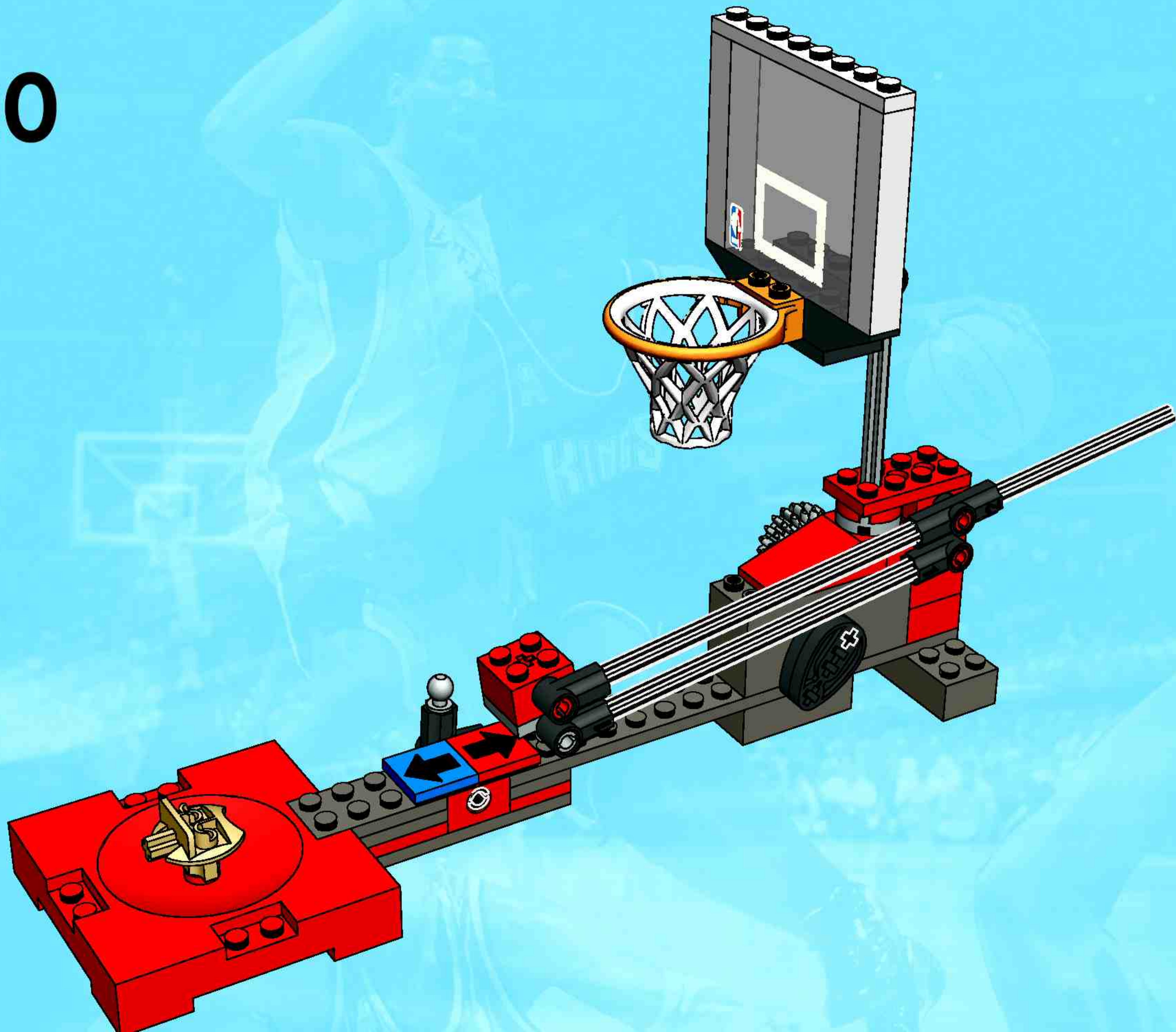

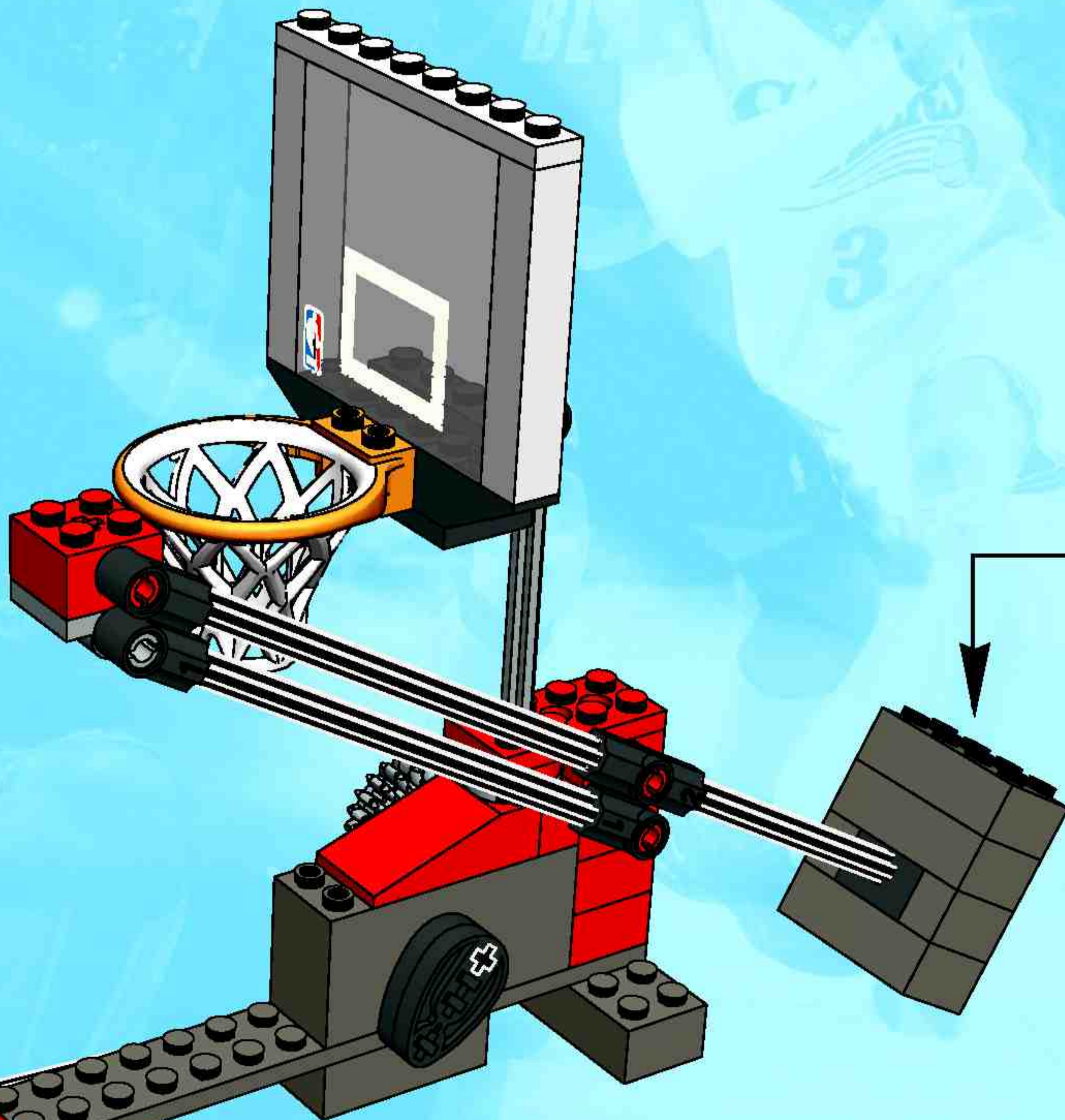

1

2

3

The inset diagram shows three steps of assembly. Step 1: A small black 1x2 Technic brick is being placed on top of a larger grey 1x6 Technic brick. Step 2: The small black brick is now attached to the top of the larger grey brick. Step 3: The assembly from step 2 is being placed on top of another larger grey 1x6 Technic brick.

22

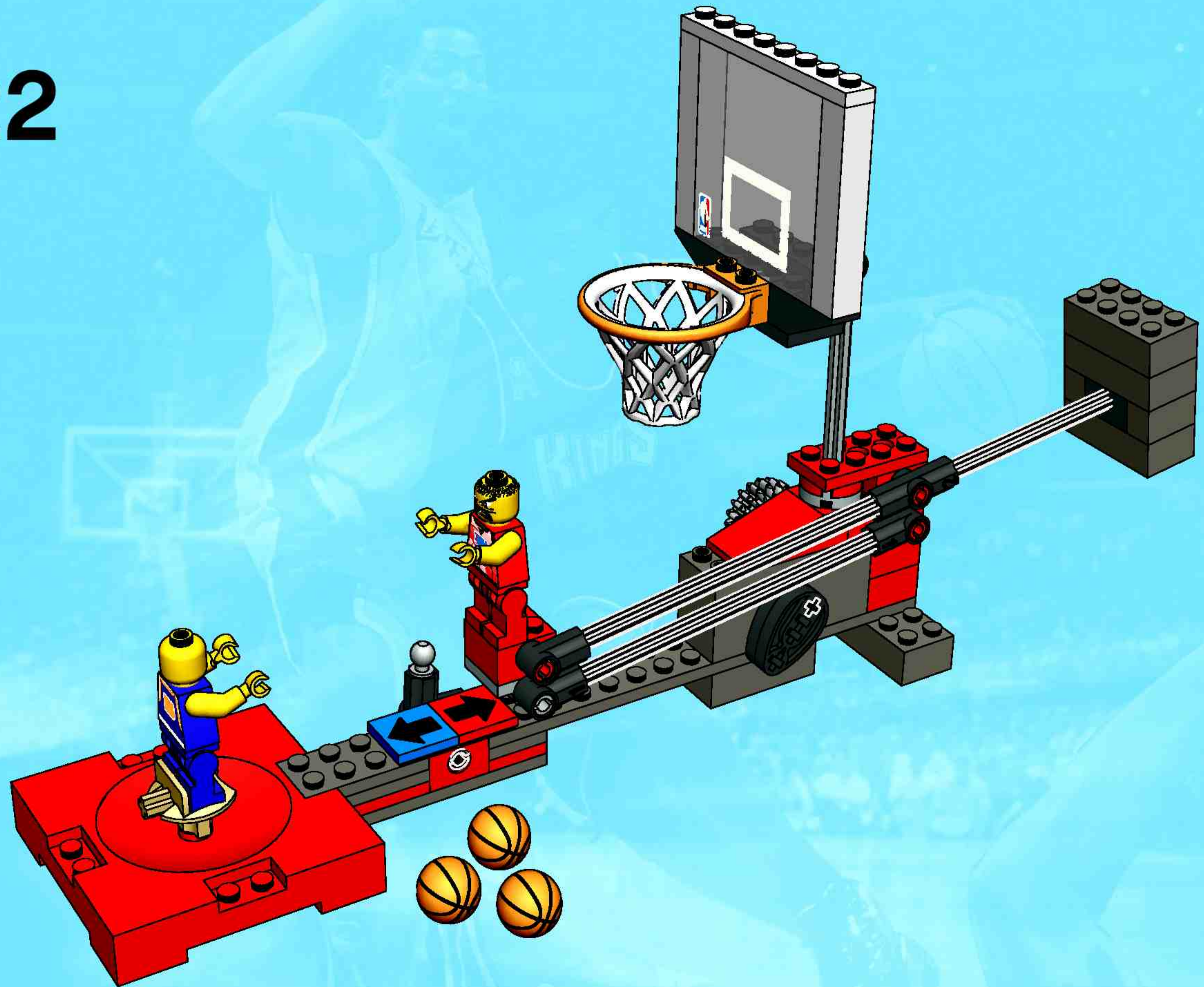



www.LEGO.com

NBA.COM





#3428

#3428

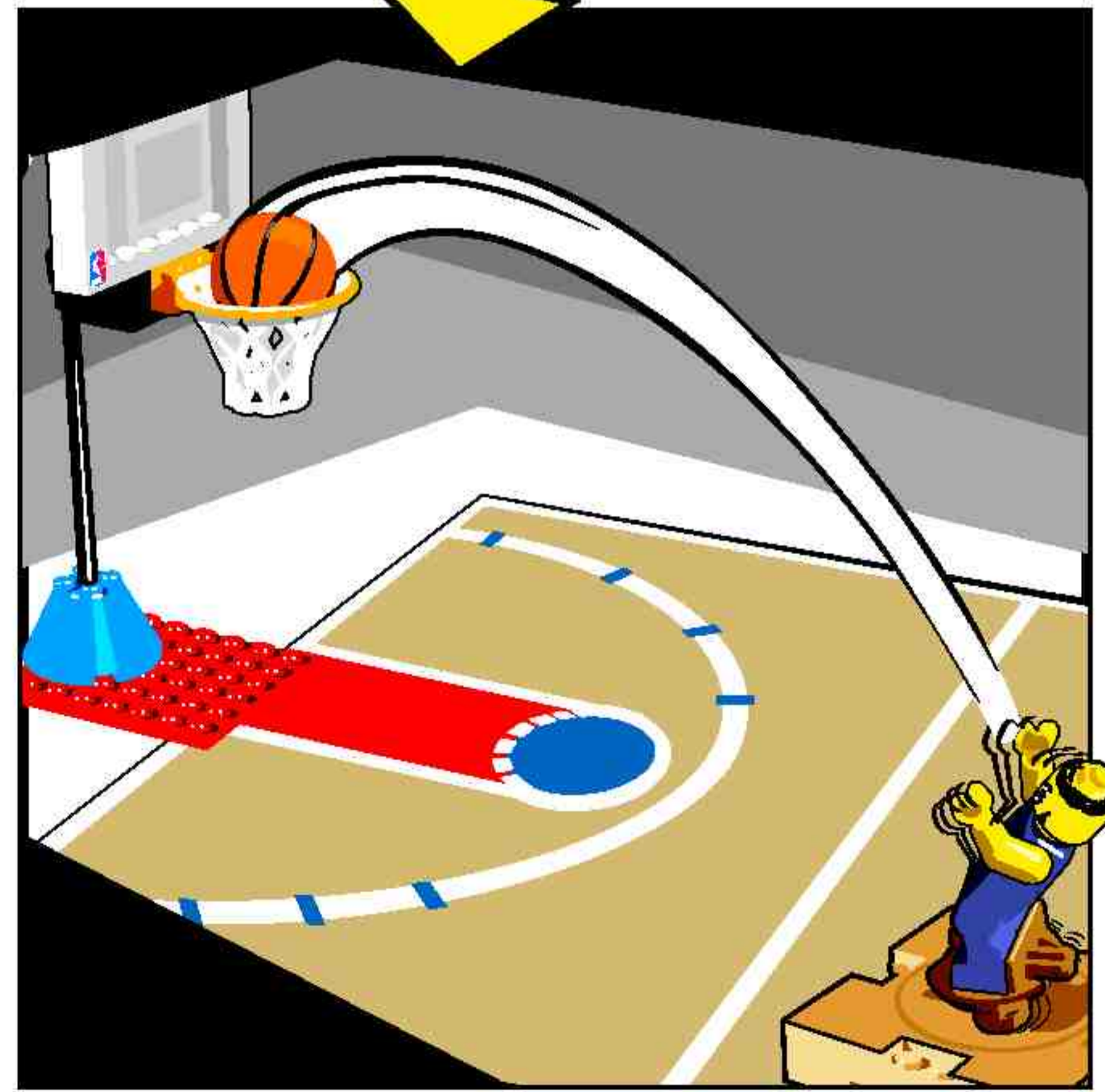



1

3428+3429

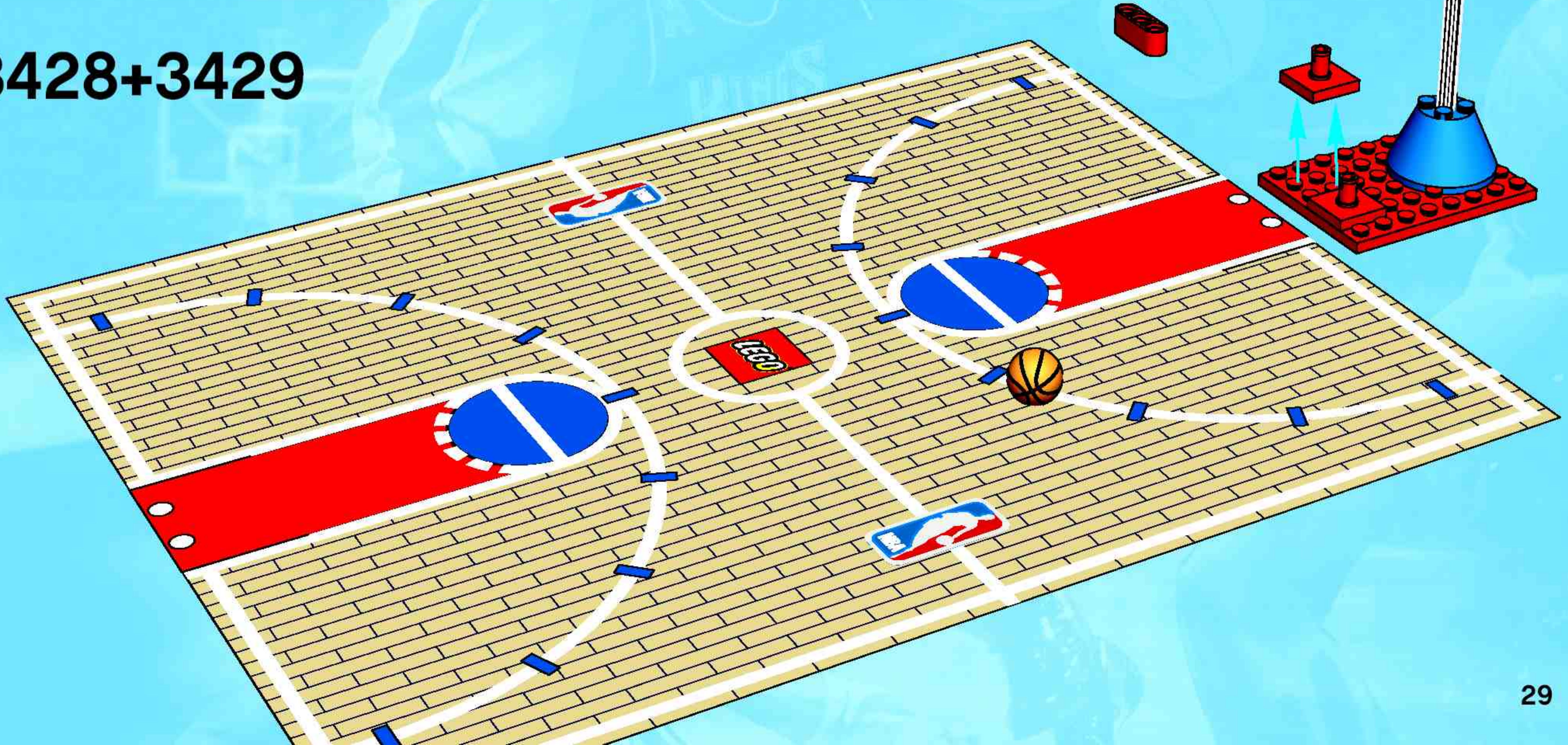

2

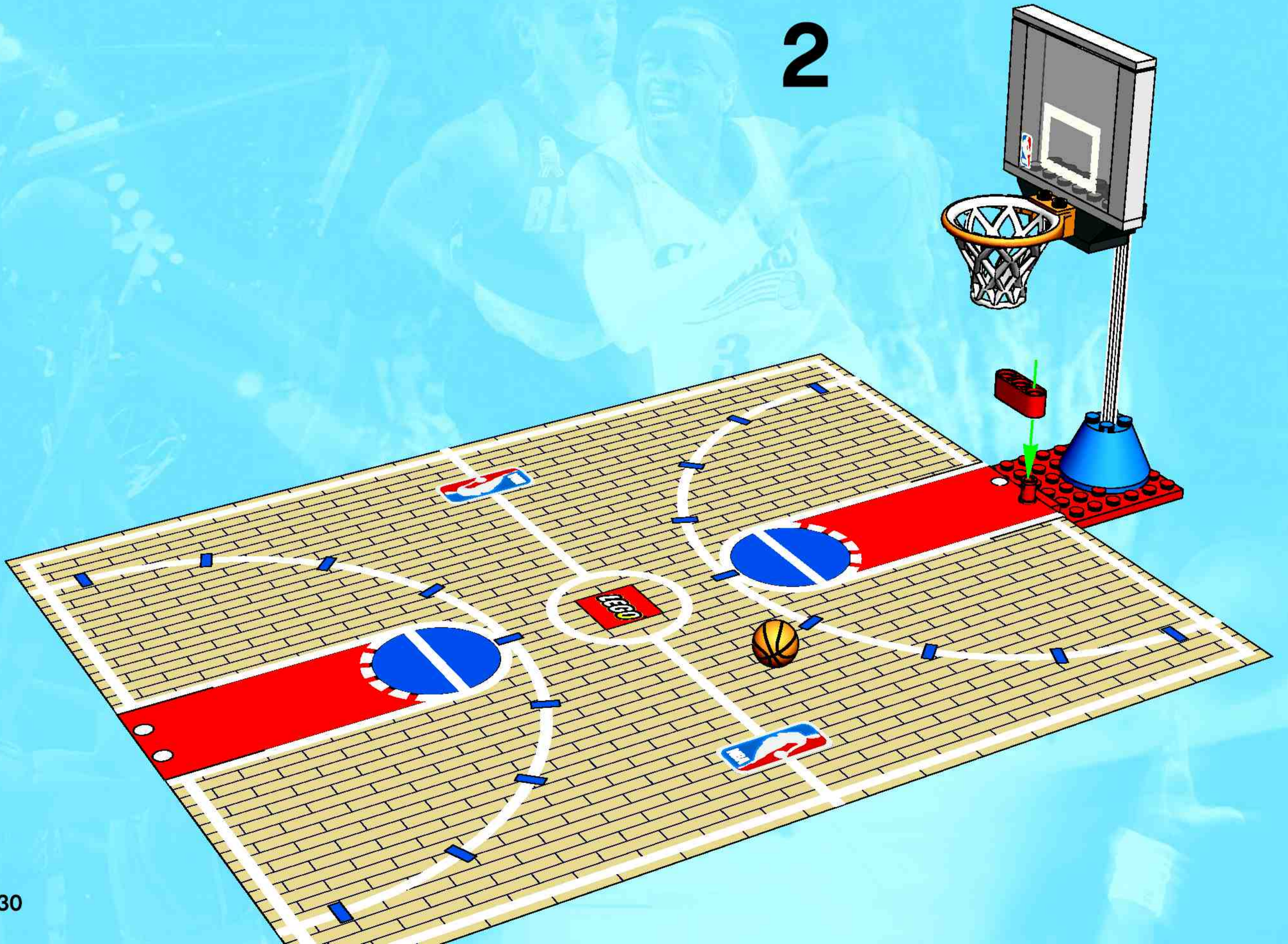



1

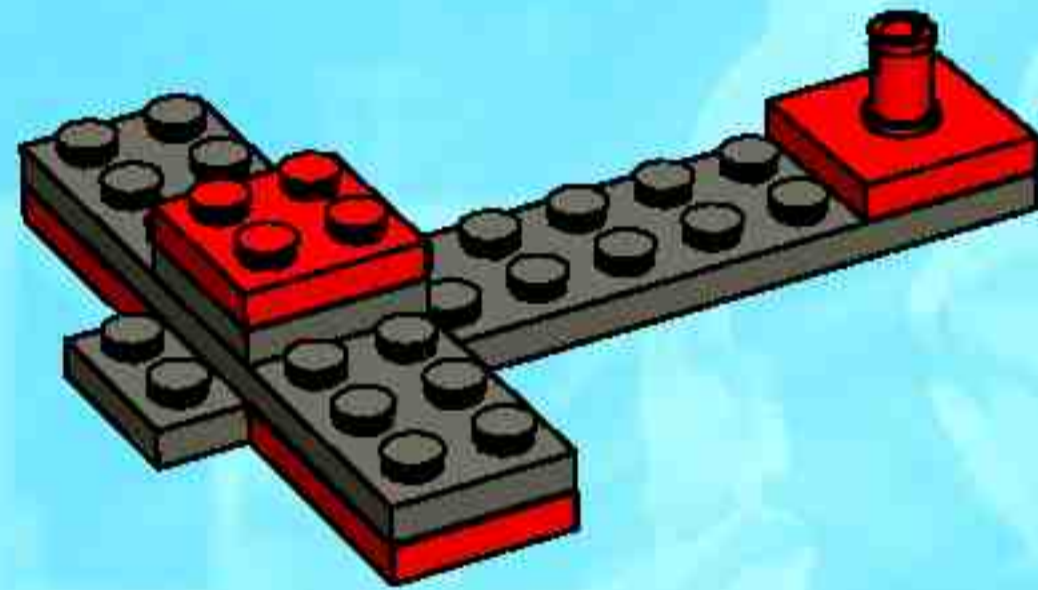

2

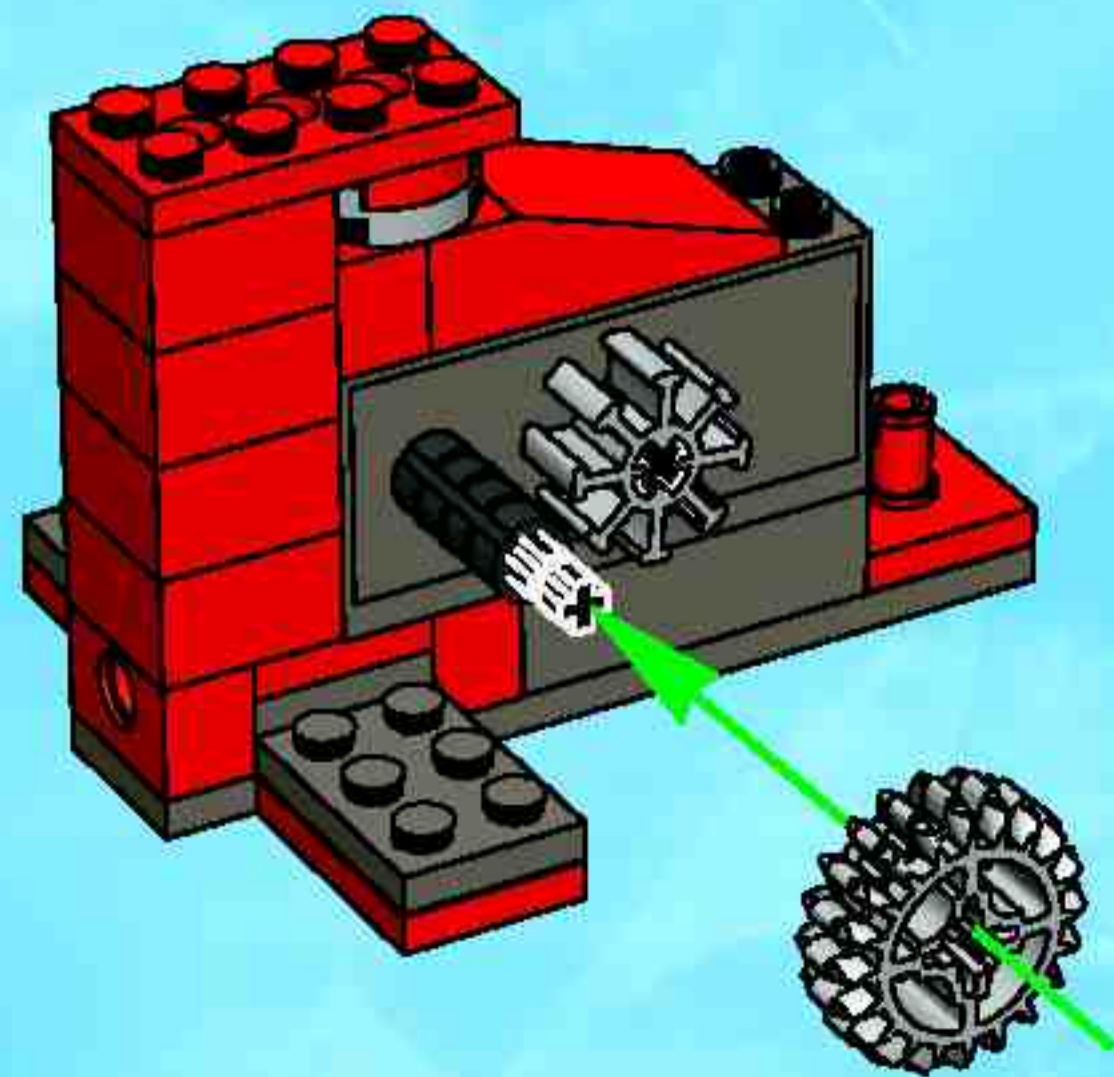

3

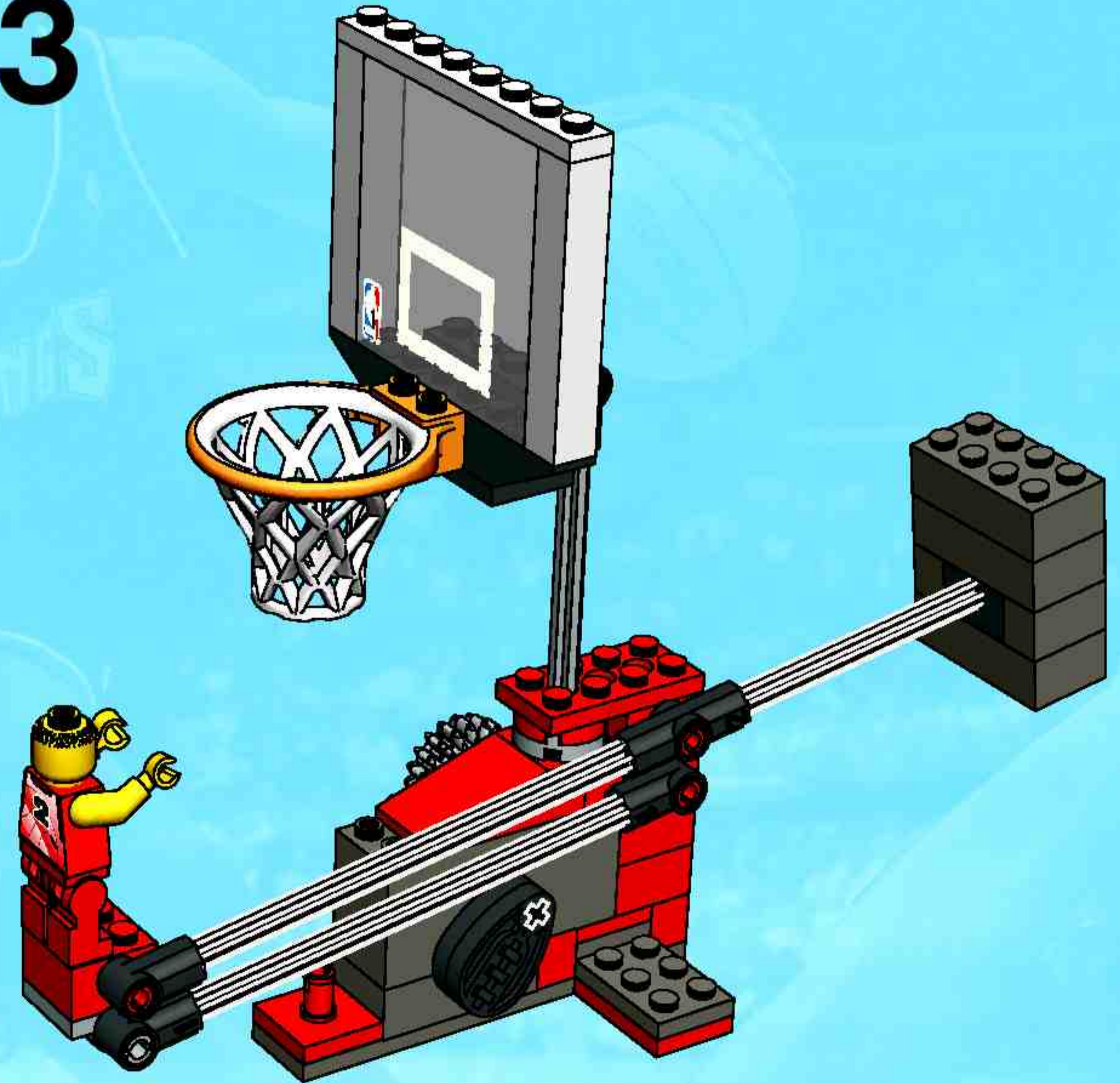

3



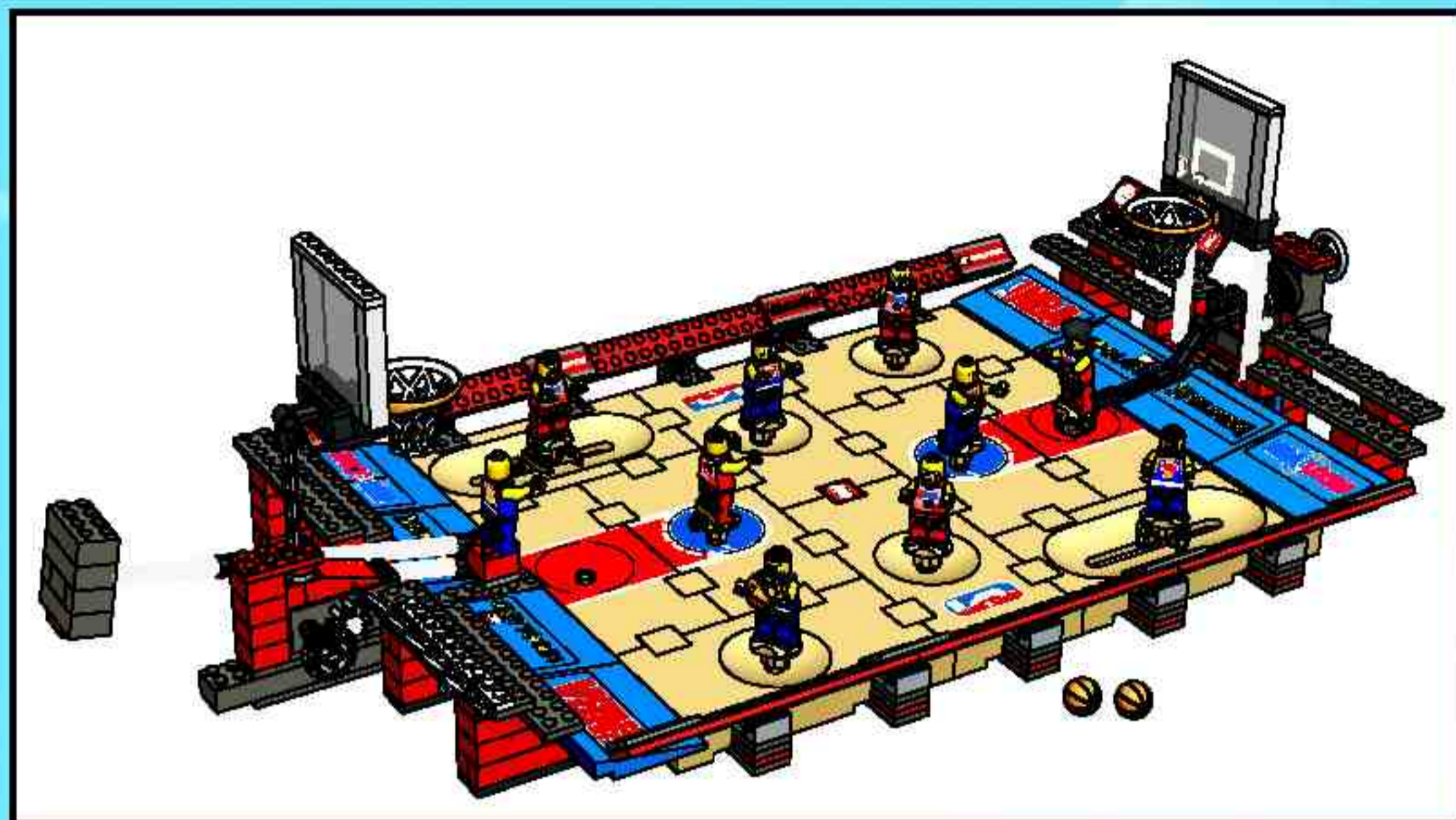

3429+3432

1

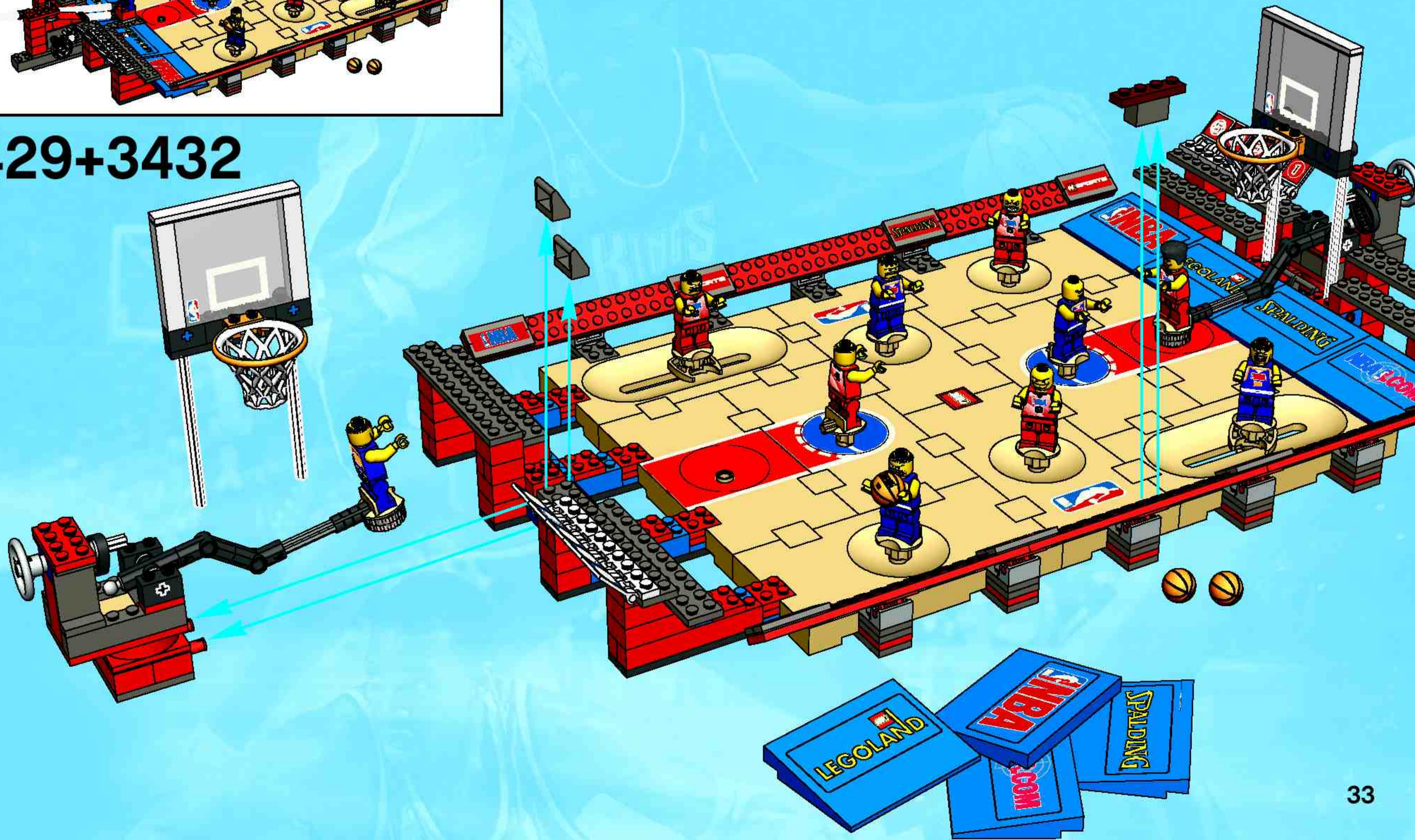

1

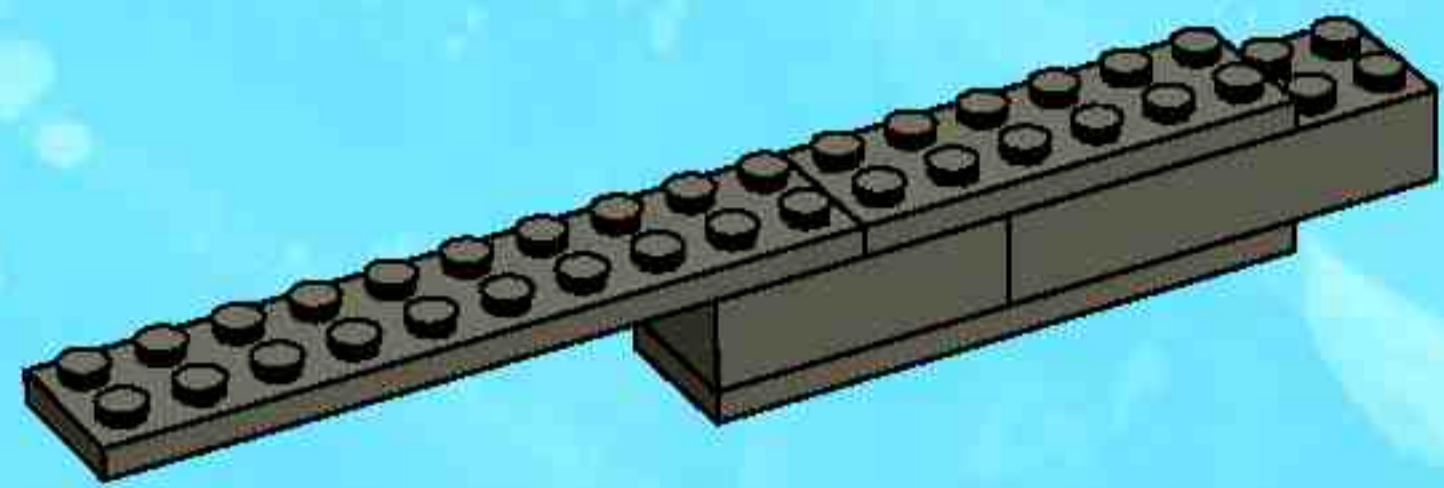

2

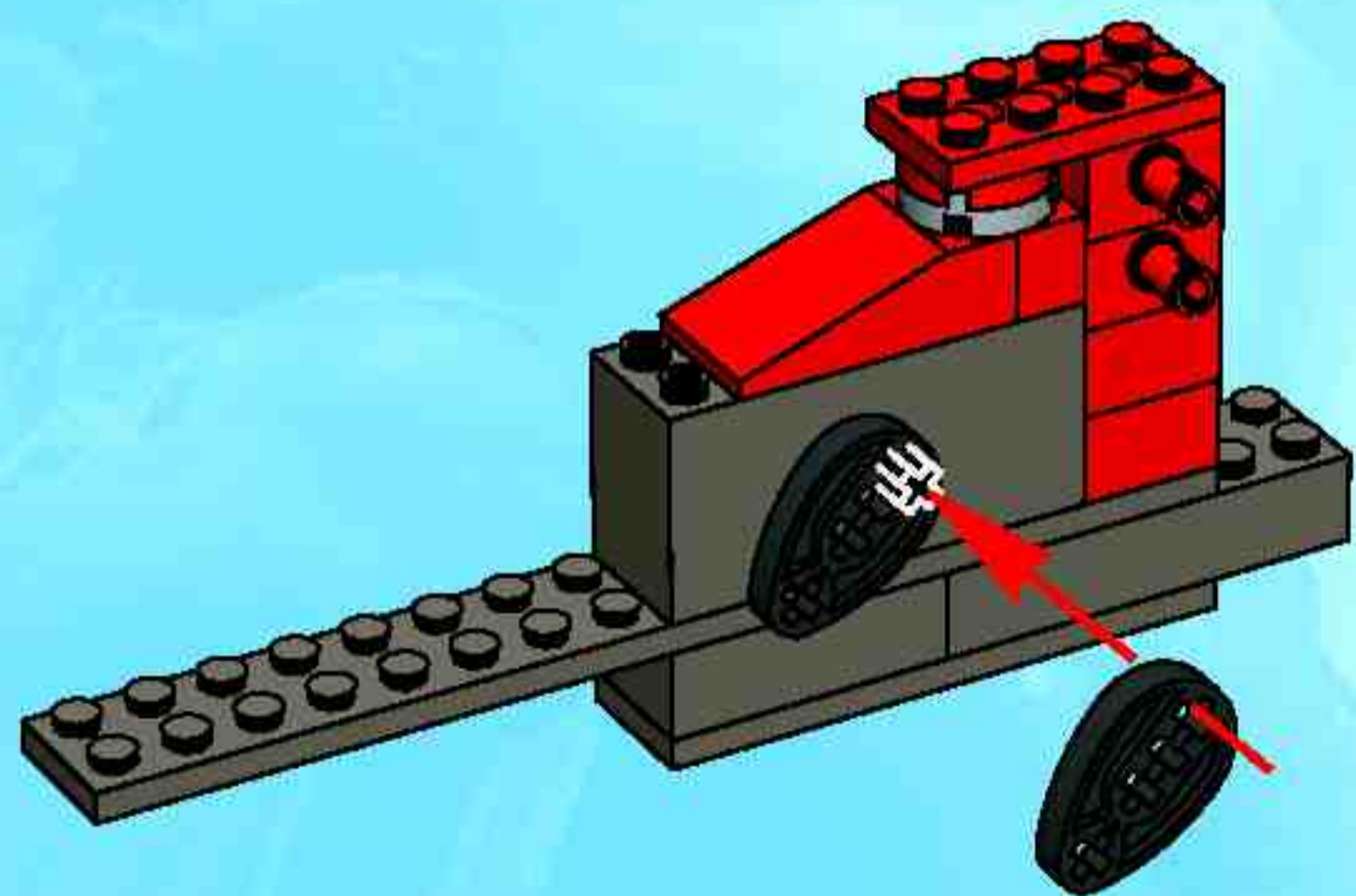

3

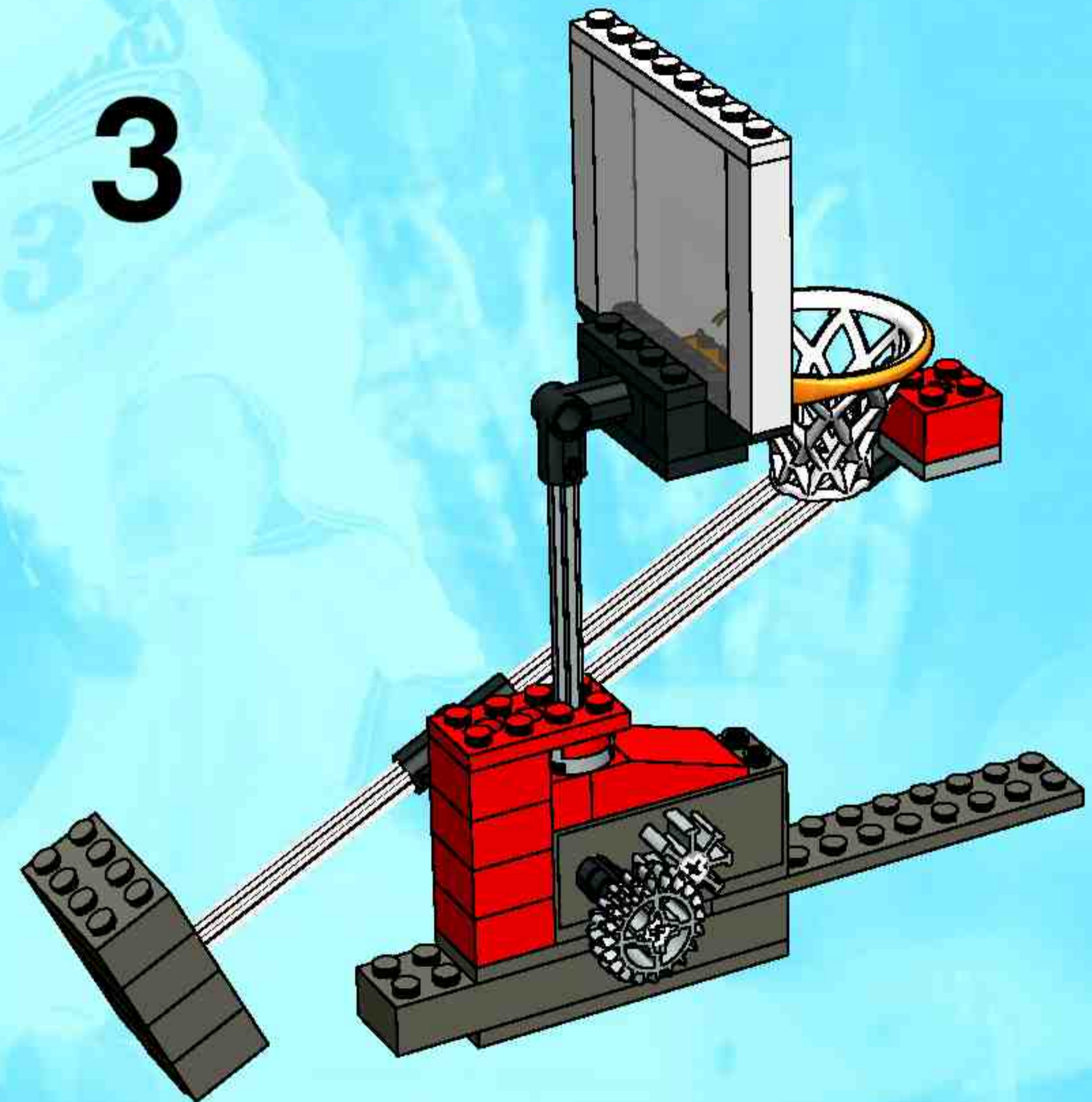

2

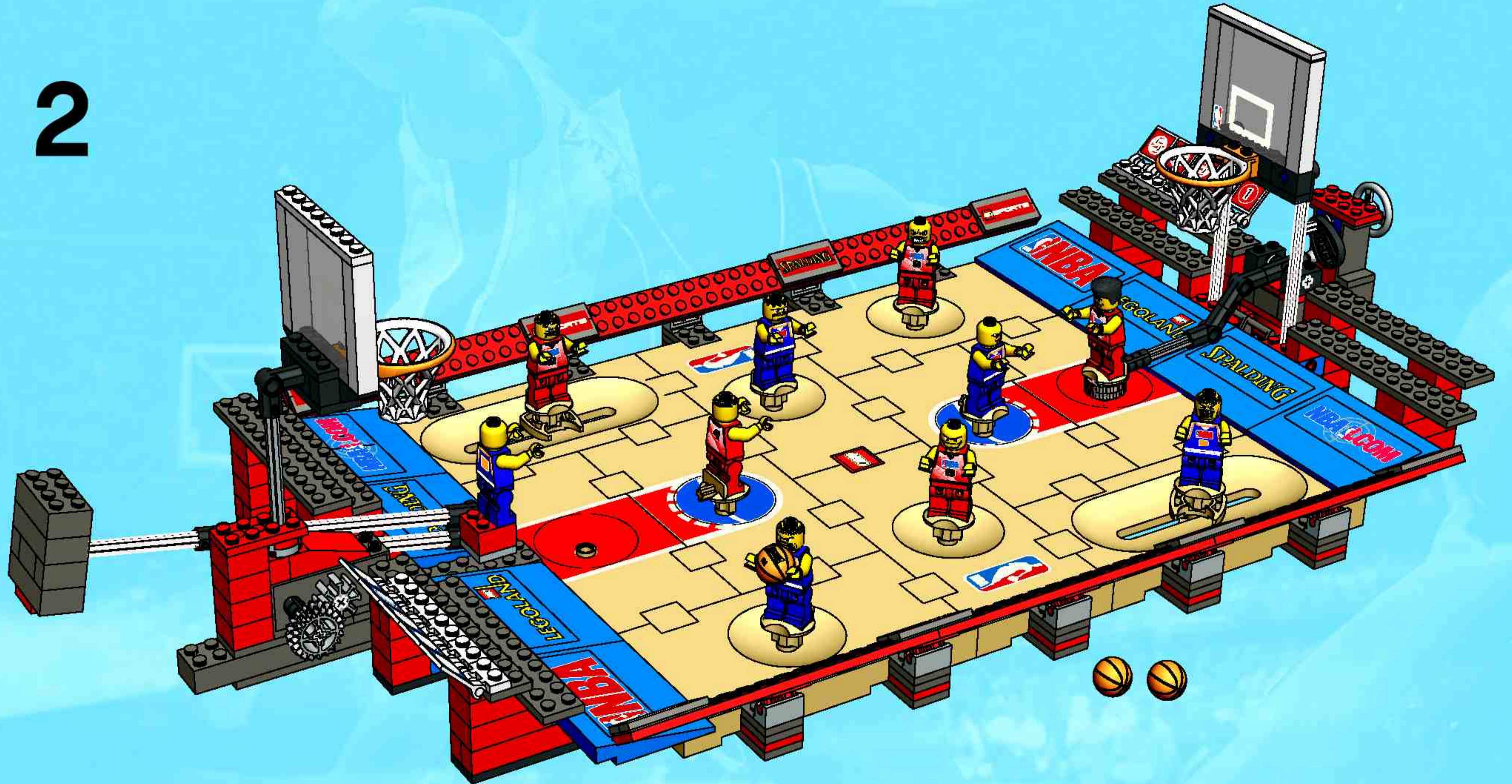

LEGO SPORTS



adidas, the adidas logo and the three stripe trademark are registered trademarks of the adidas-Salomon group, used with permission. Fevernova and the Trigon logo are trademarks of the adidas-Salomon group, used with permission.

 www.LEGO.com

SPALDING is a trademark of Spalding Sports Worldwide, Inc. or Lisco Sports, Inc., a Spalding affiliate. © Spalding Sports Worldwide, Inc. 2002

NBA identifications depicted are the exclusive property of NBA Properties, Inc. and/or the NBA Member Teams, and are used with permission.

LEGO and the LEGO logo are trademarks of the LEGO Group. ©2002 The LEGO Group.

