

3428

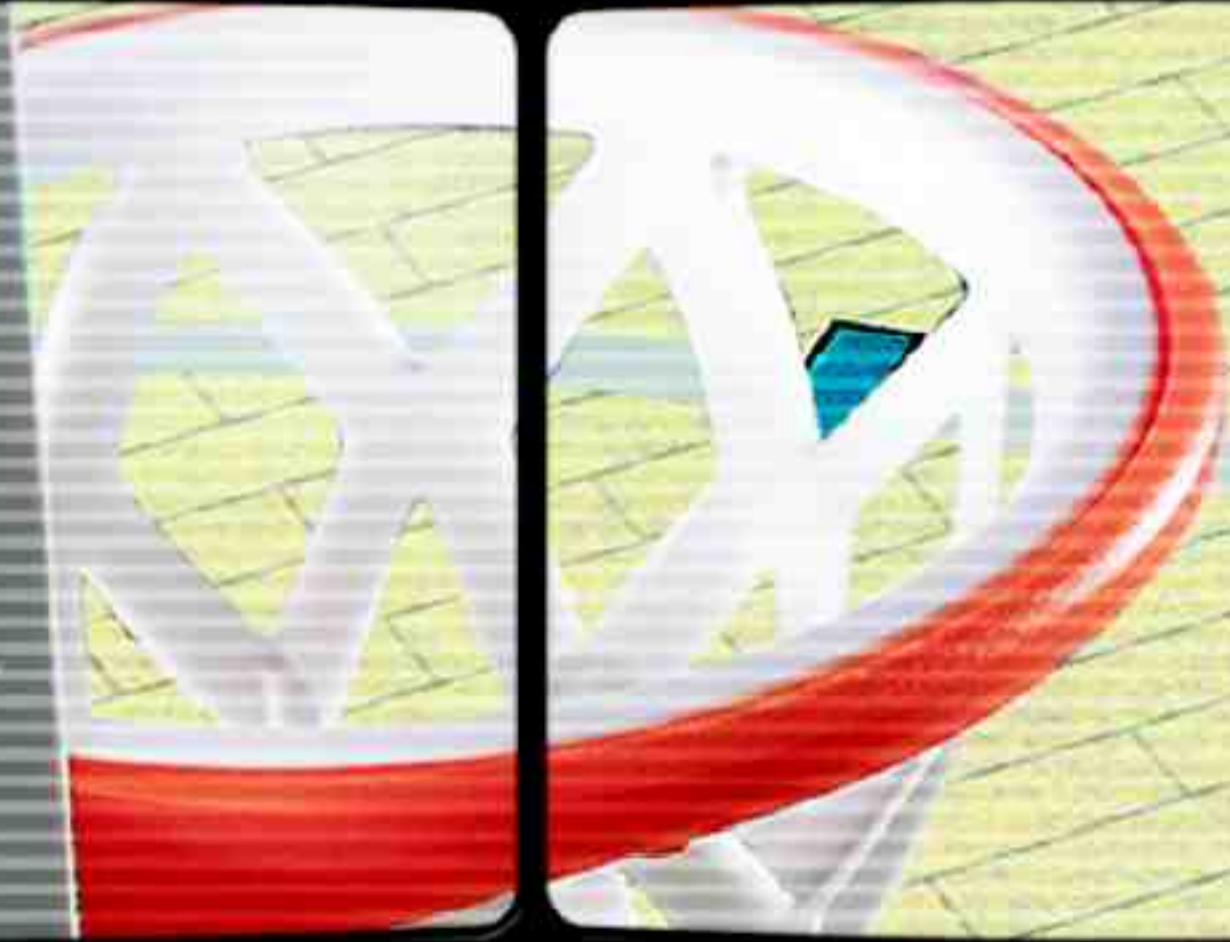

SPORTS

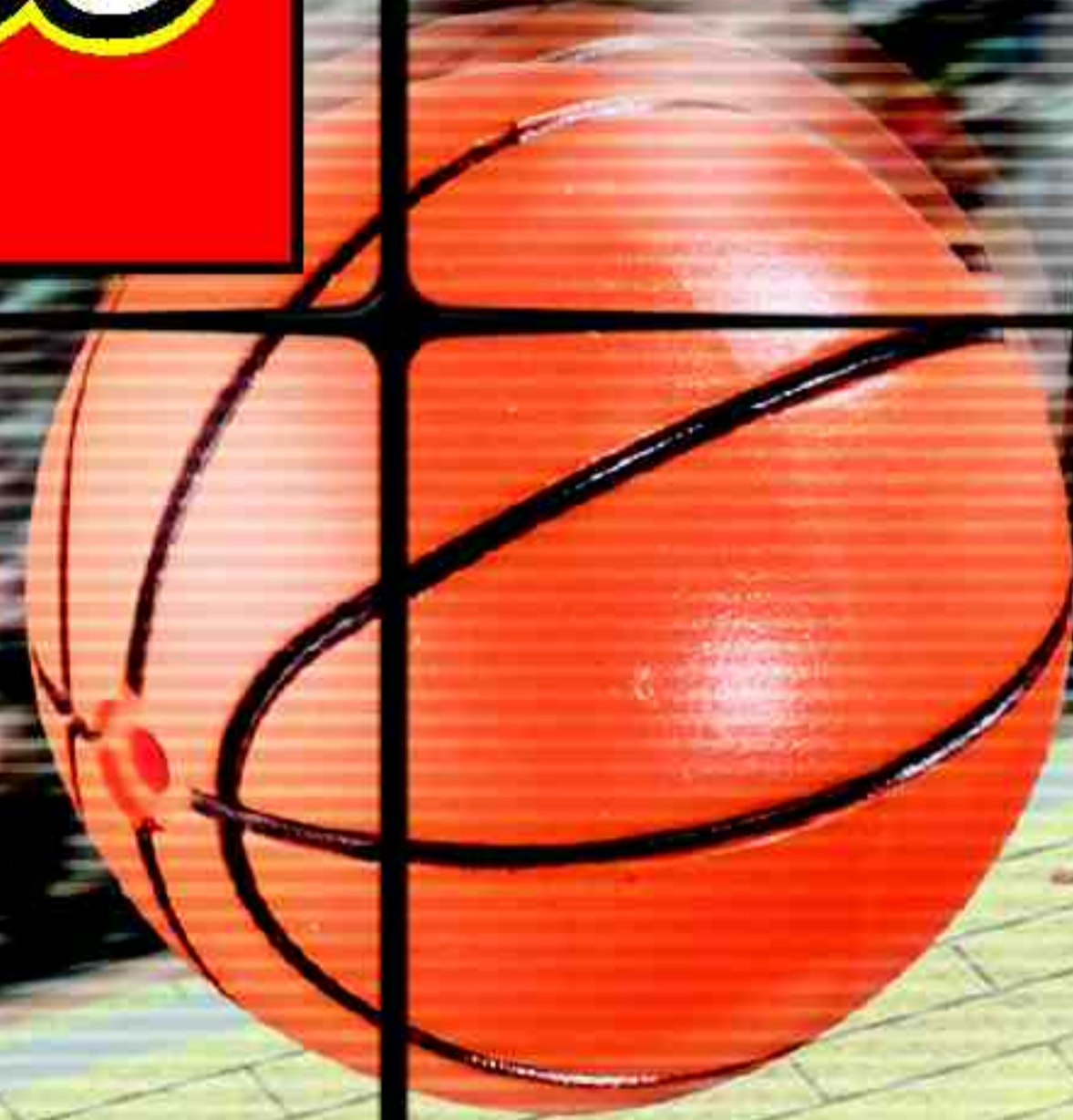

4195740





3560



3561



3562



3563



3564



3565



3566



3567



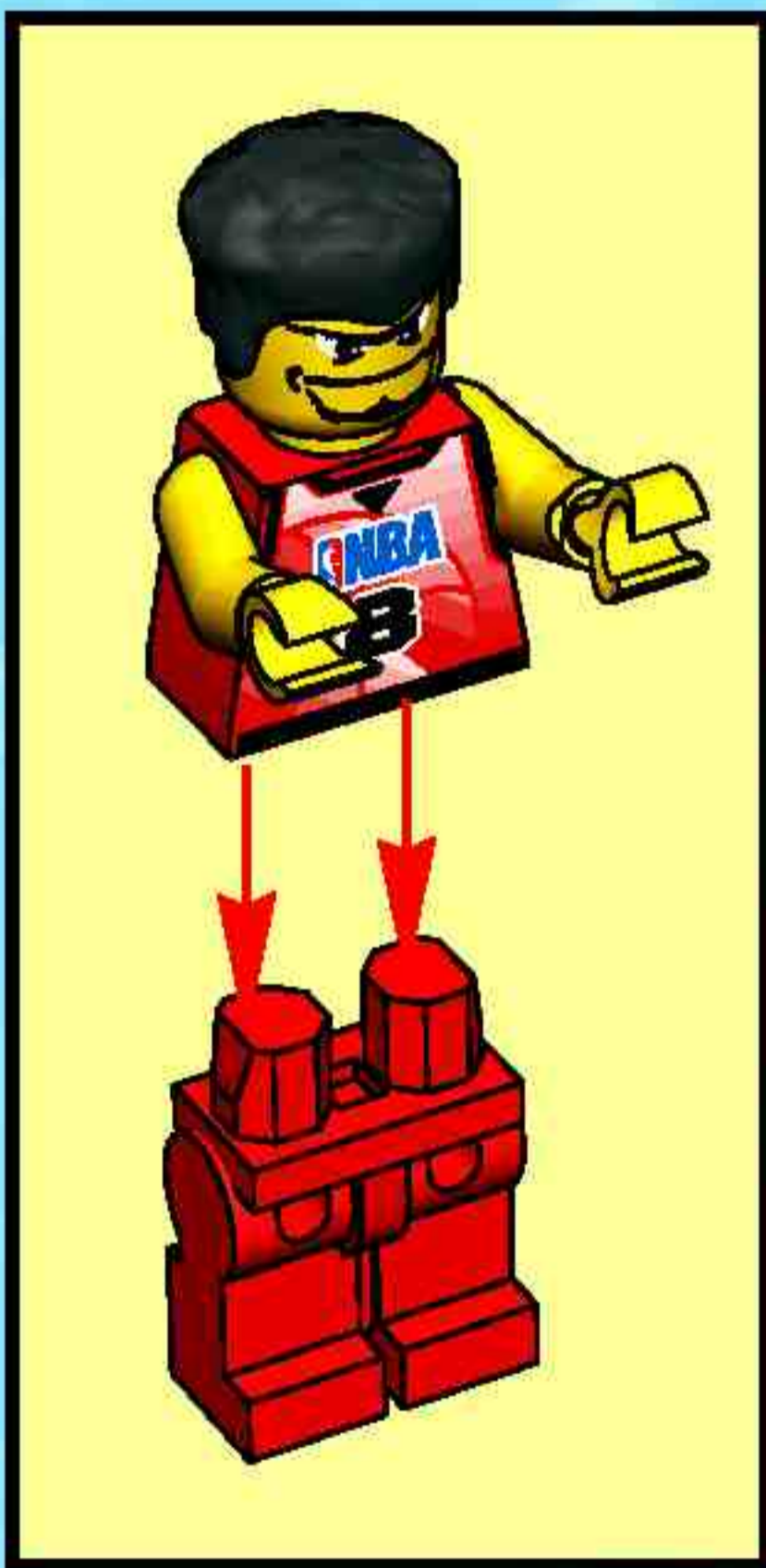

1

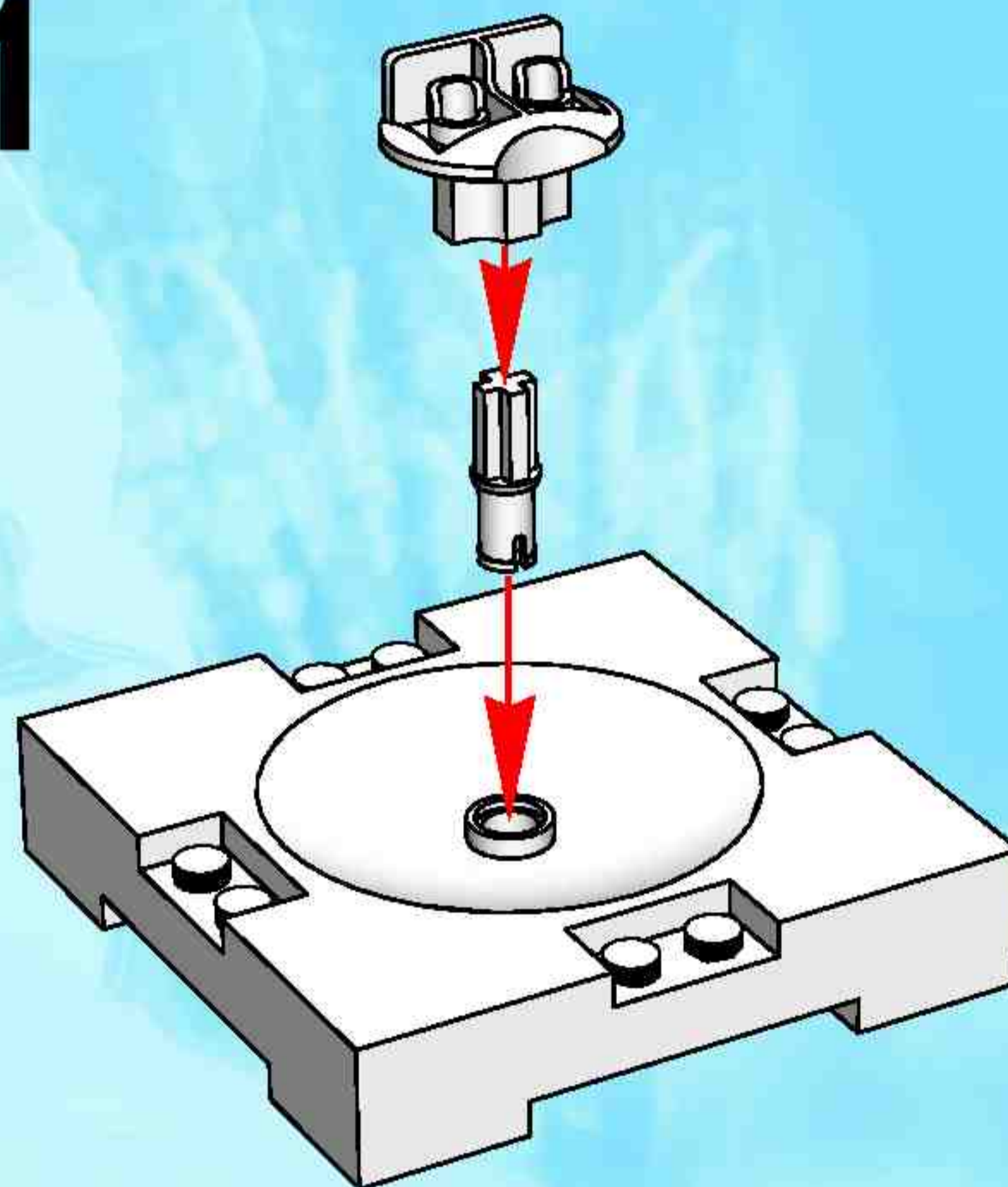

2

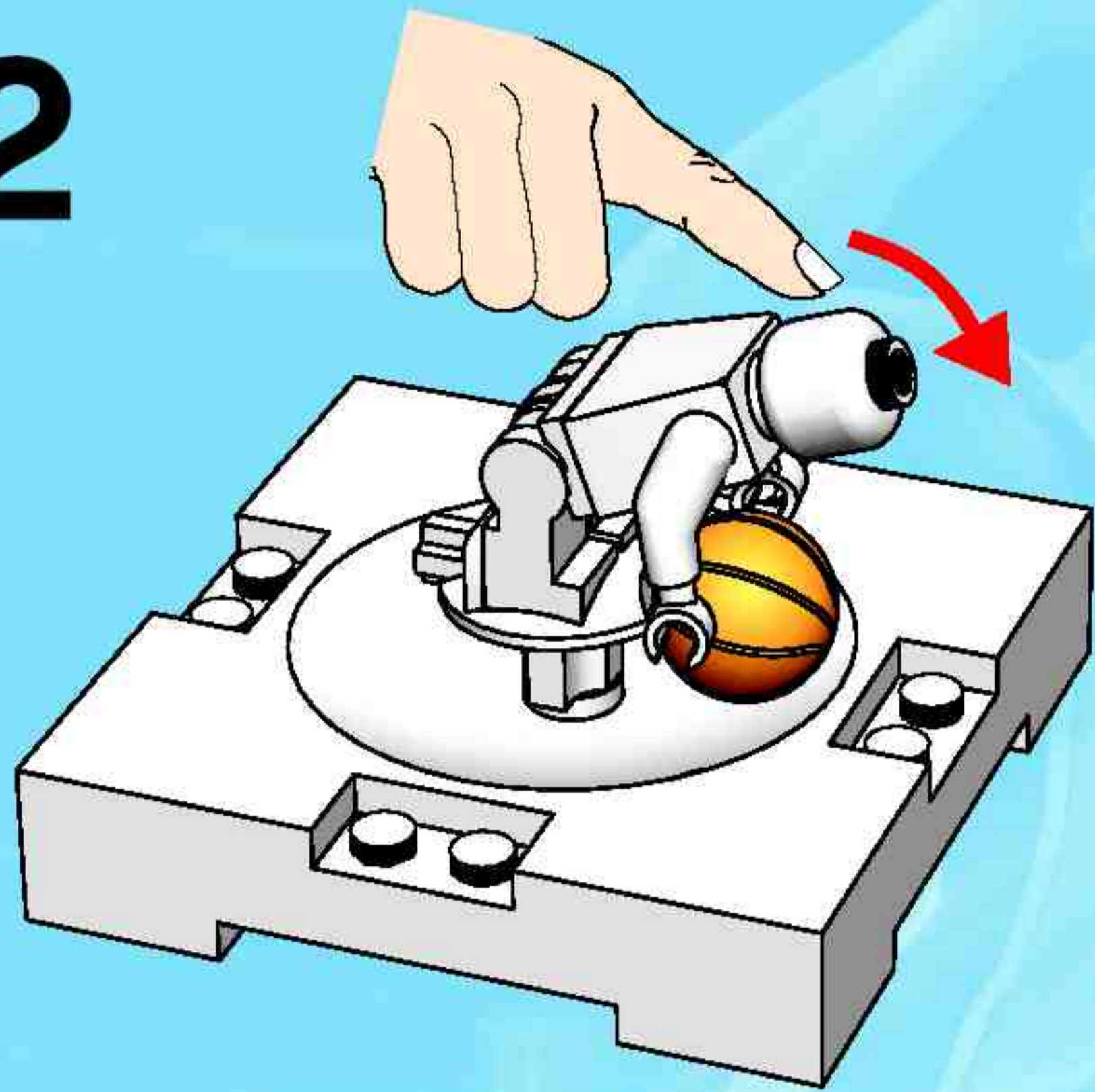

3

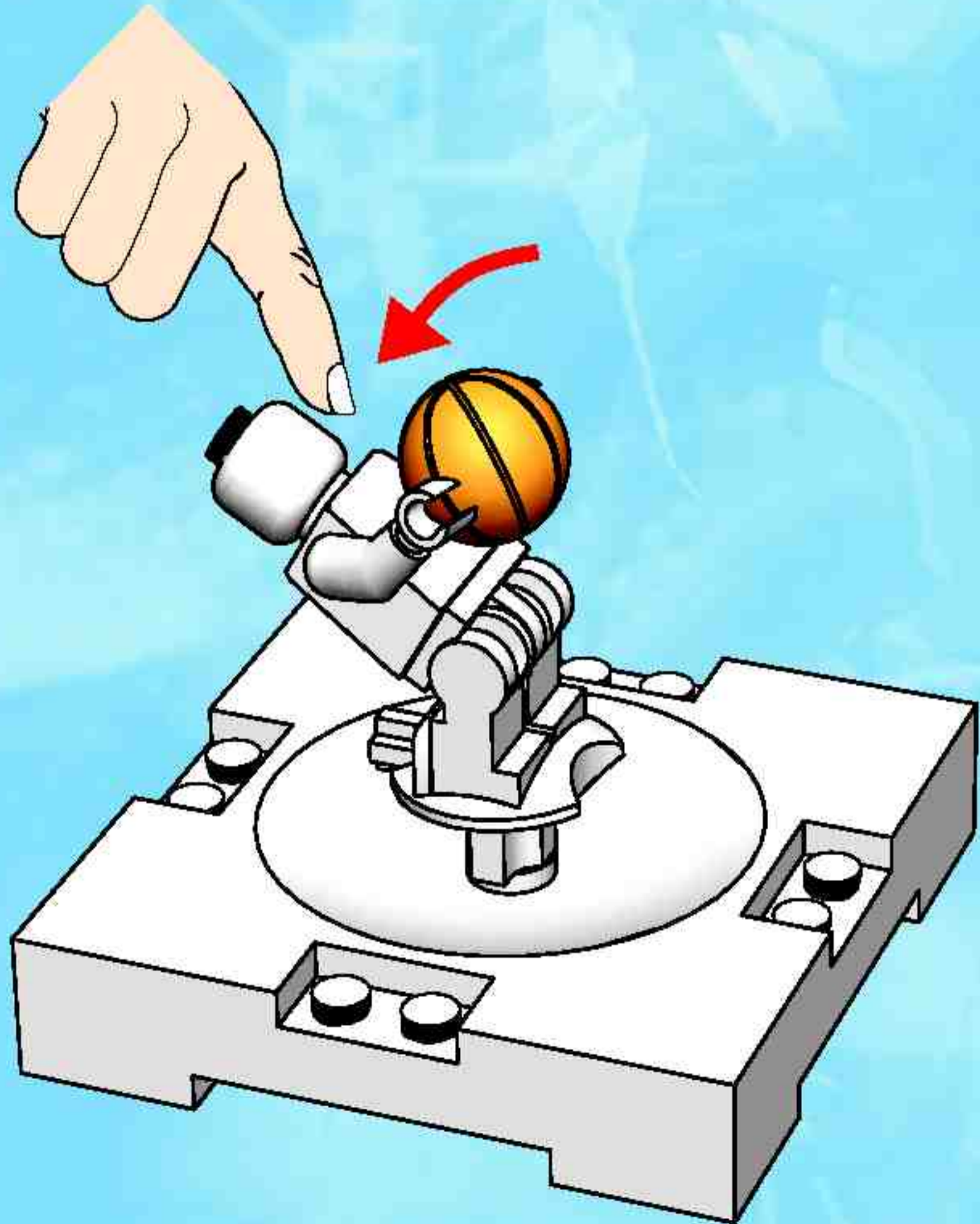

4

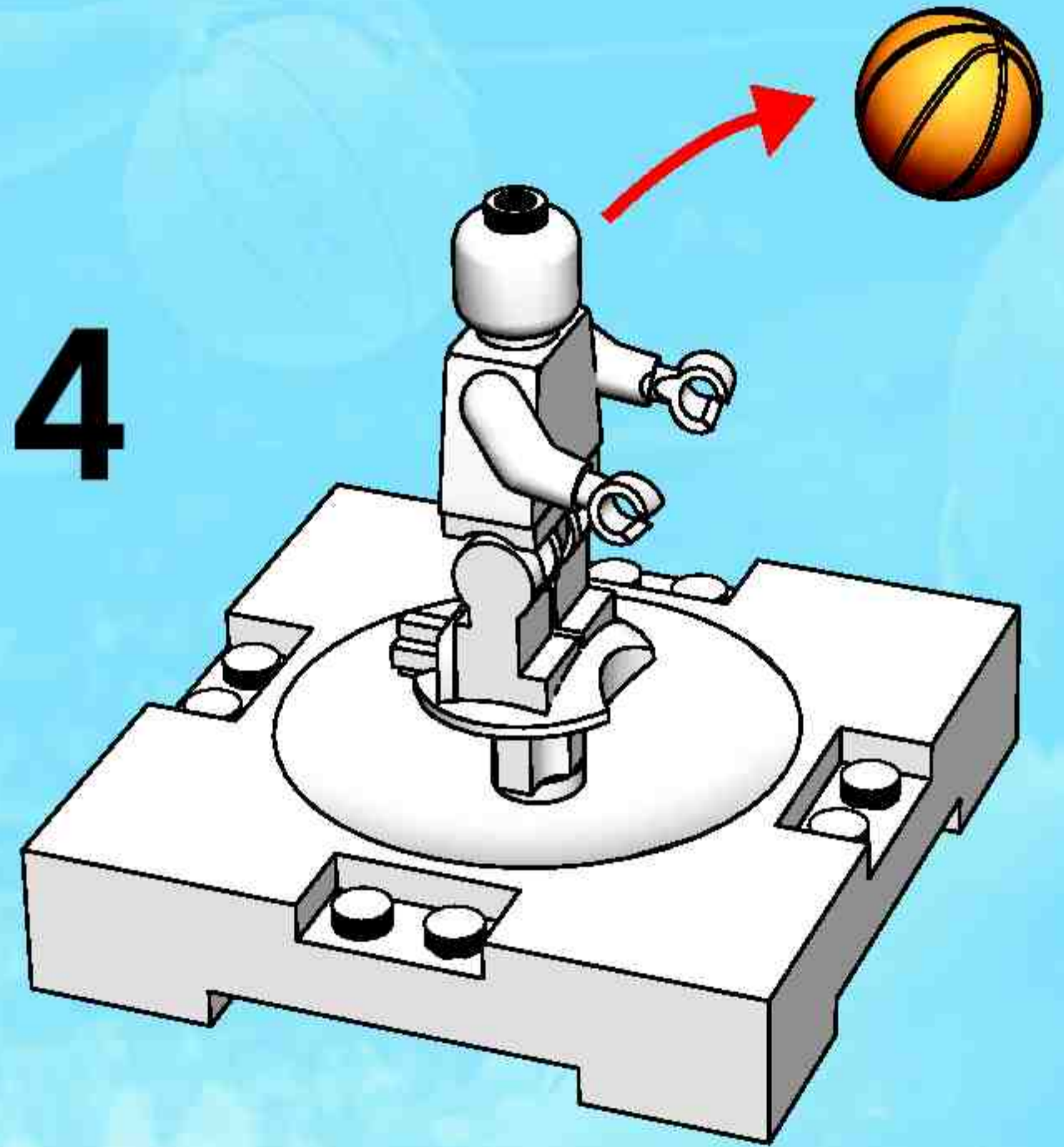

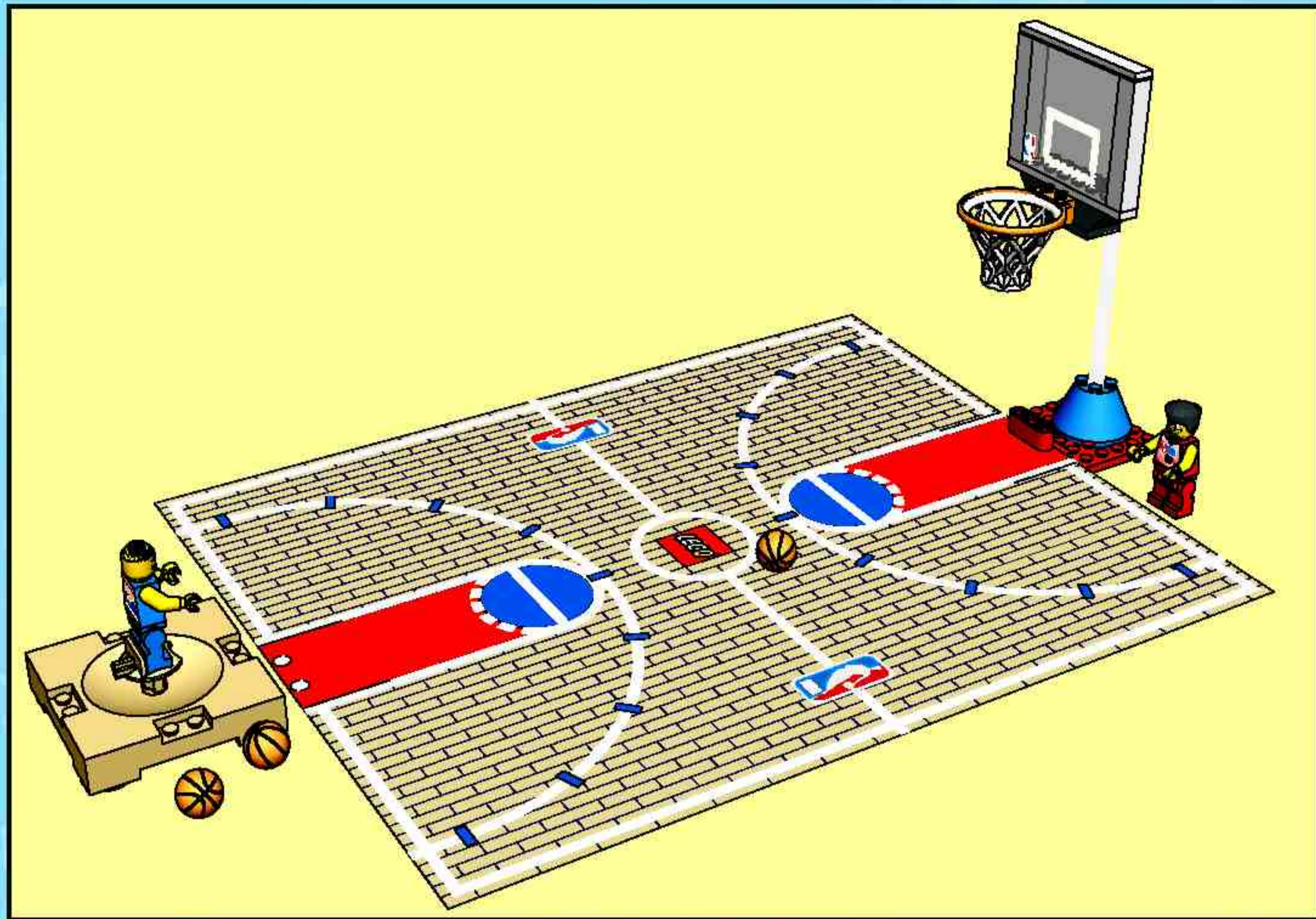

1

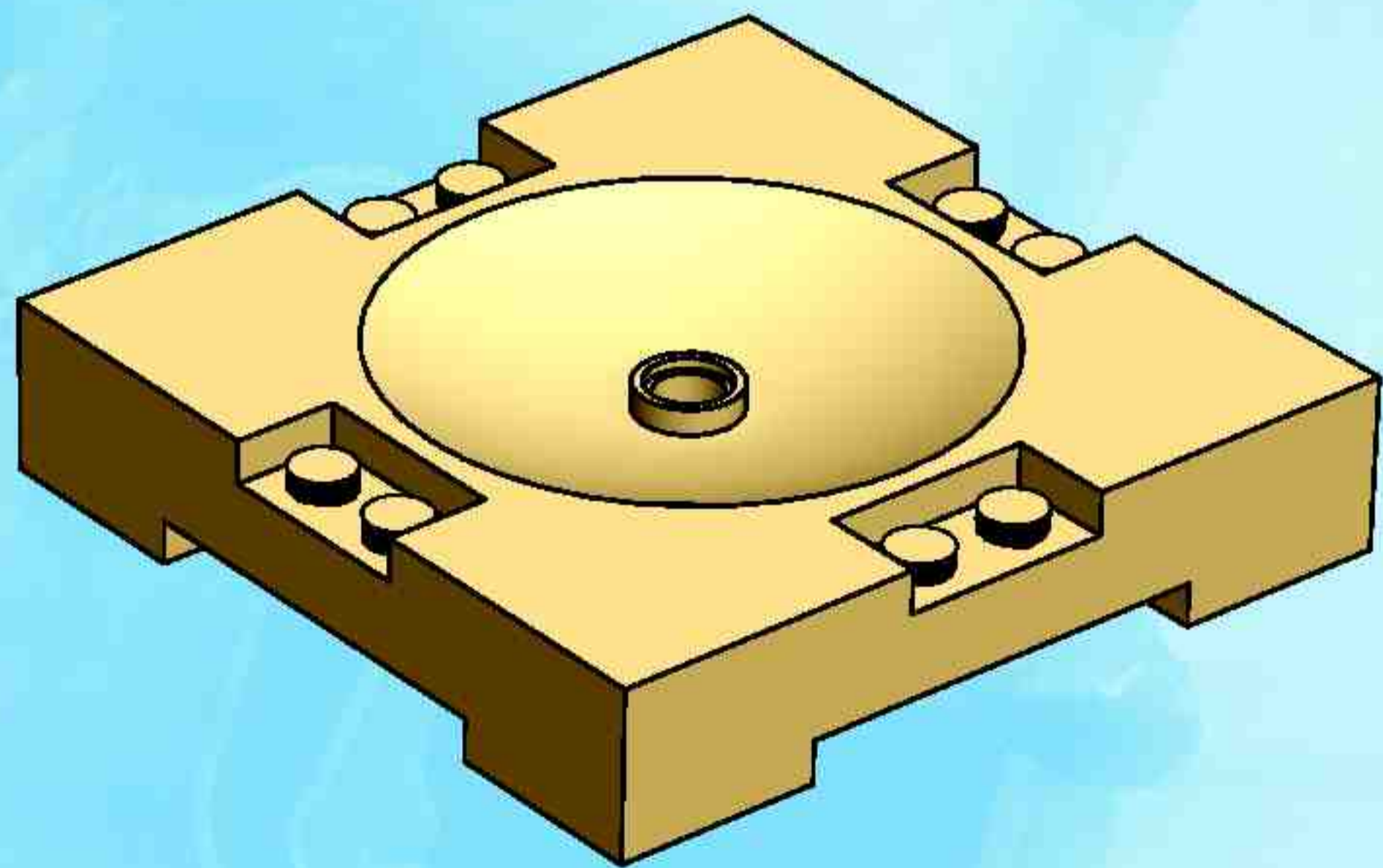

2

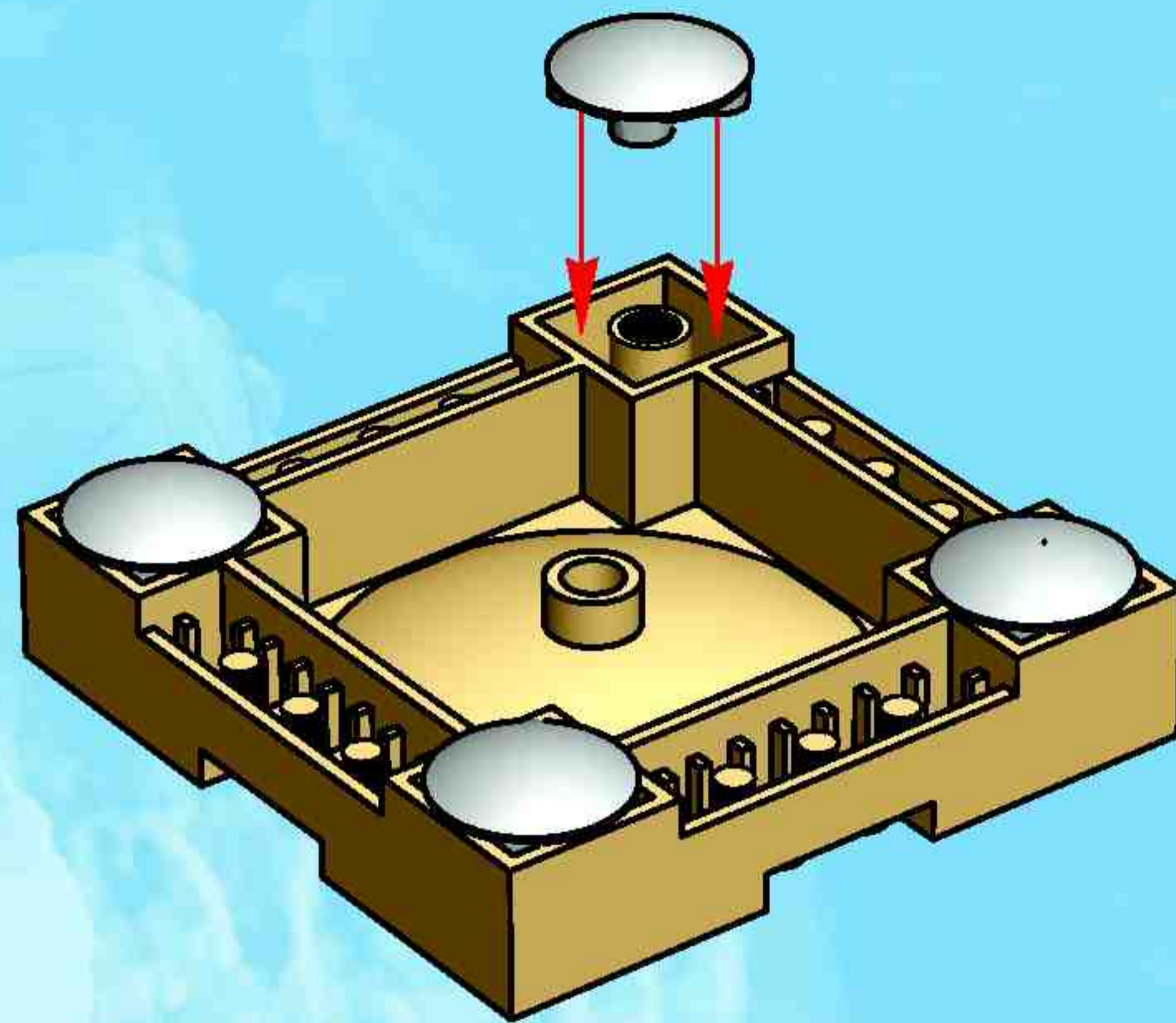

3

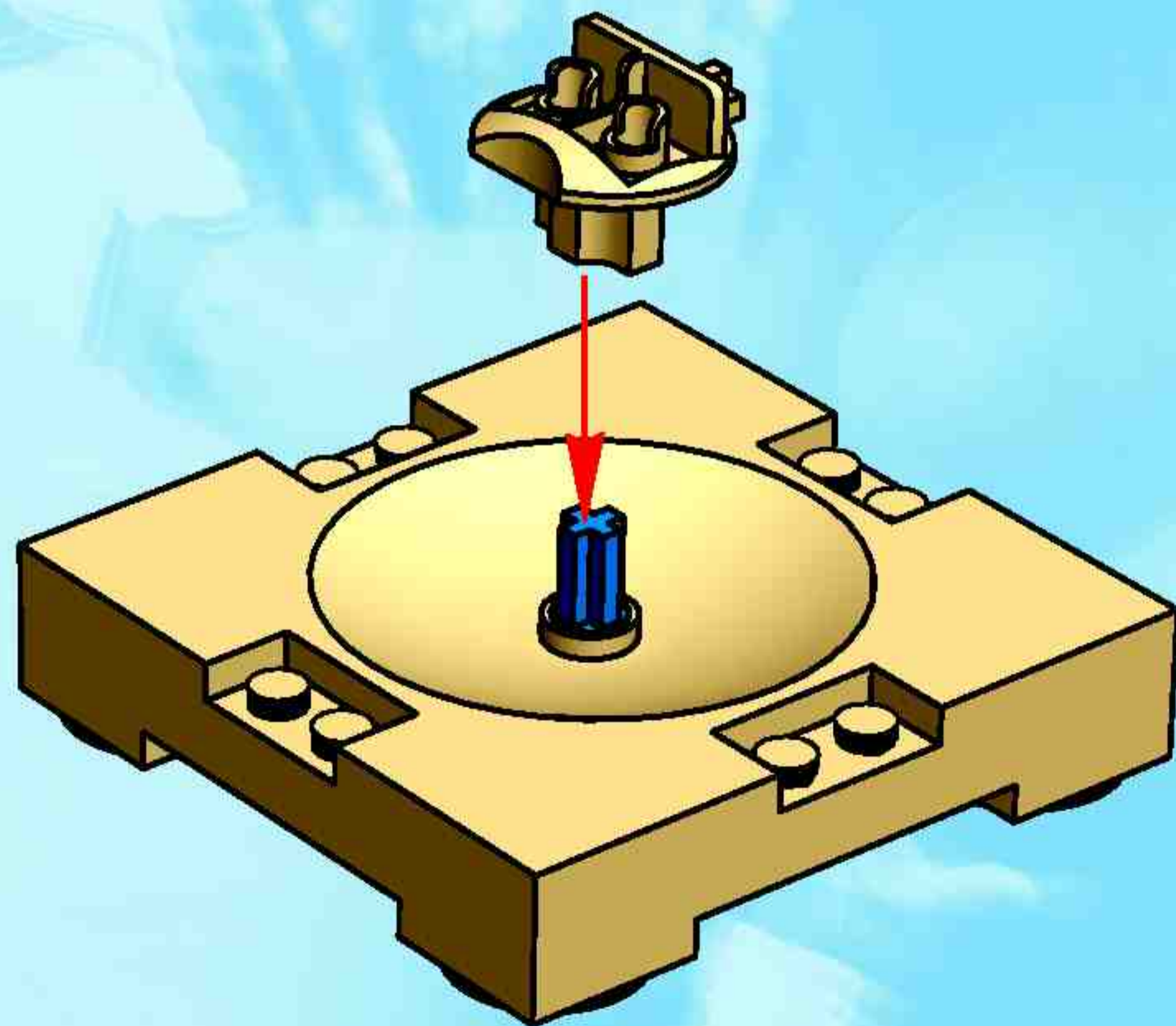

1

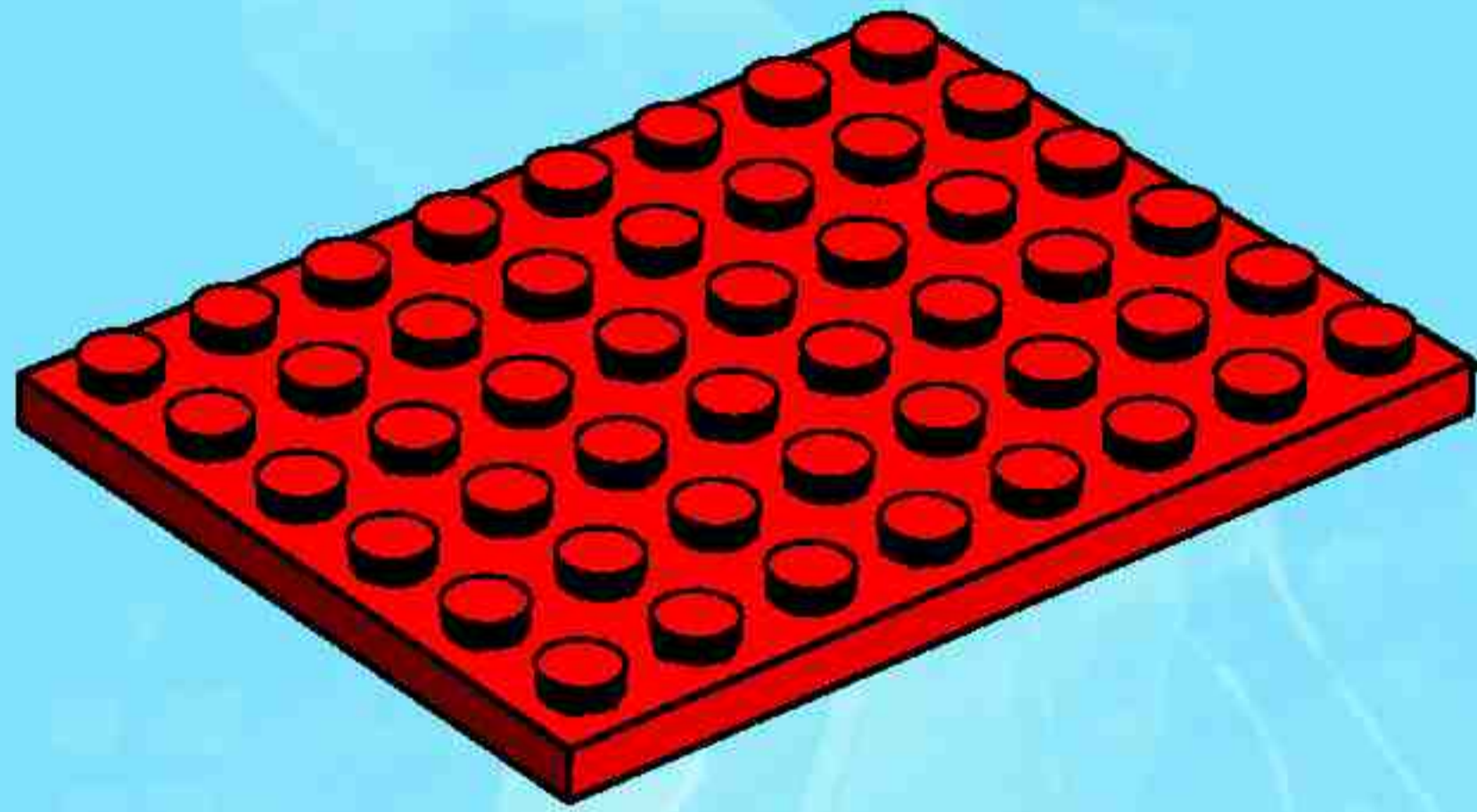

2

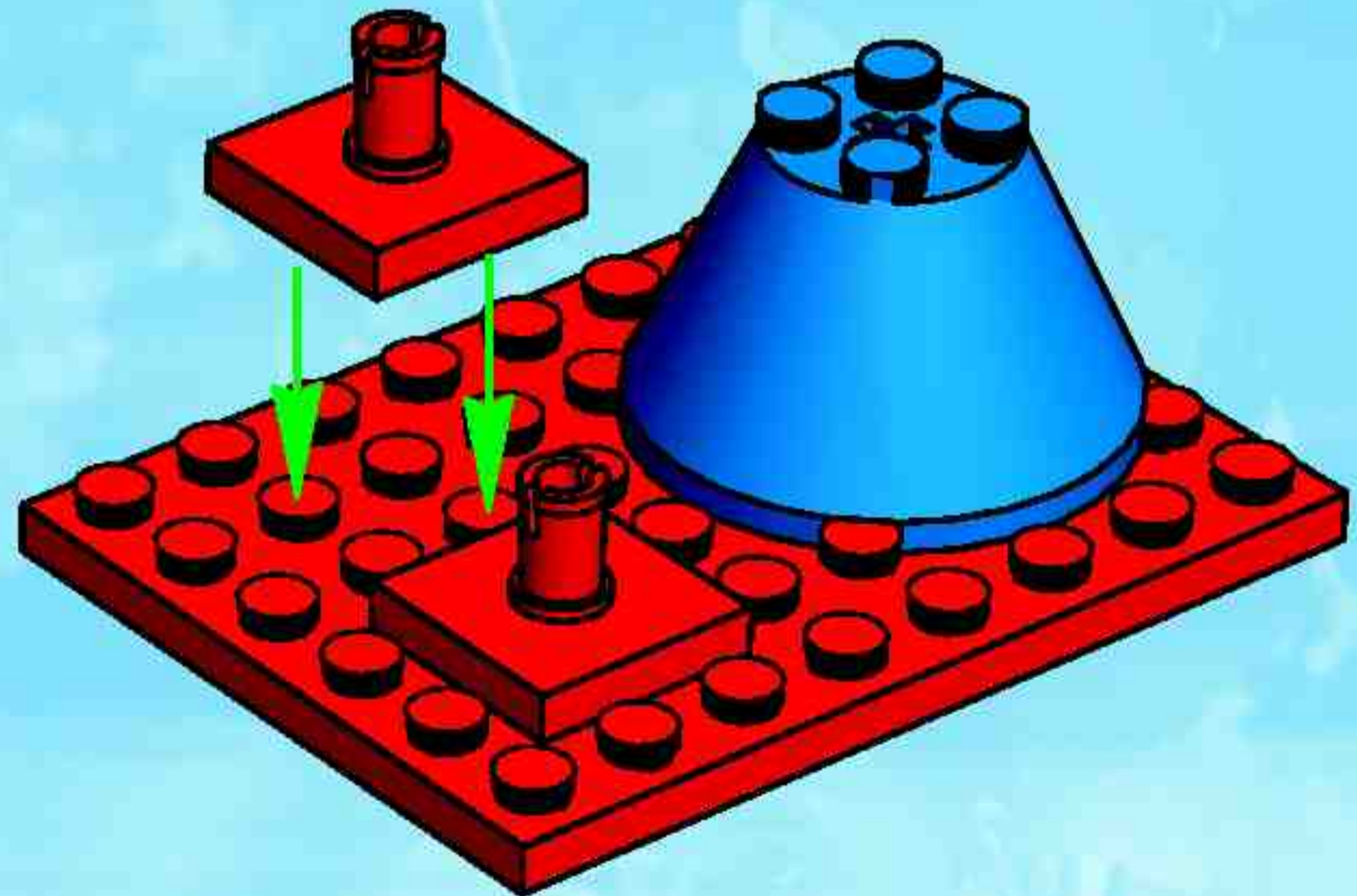

3

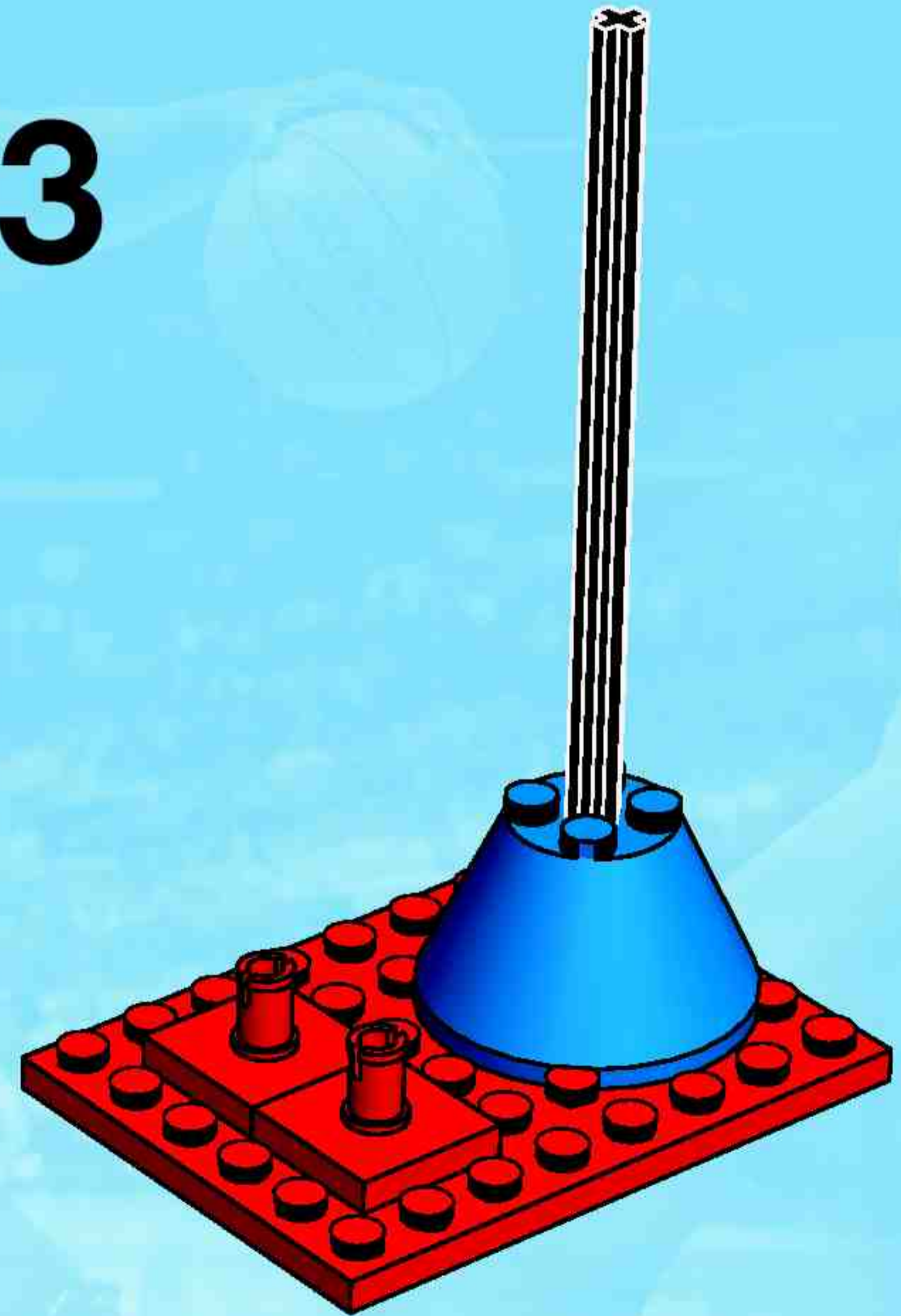

4

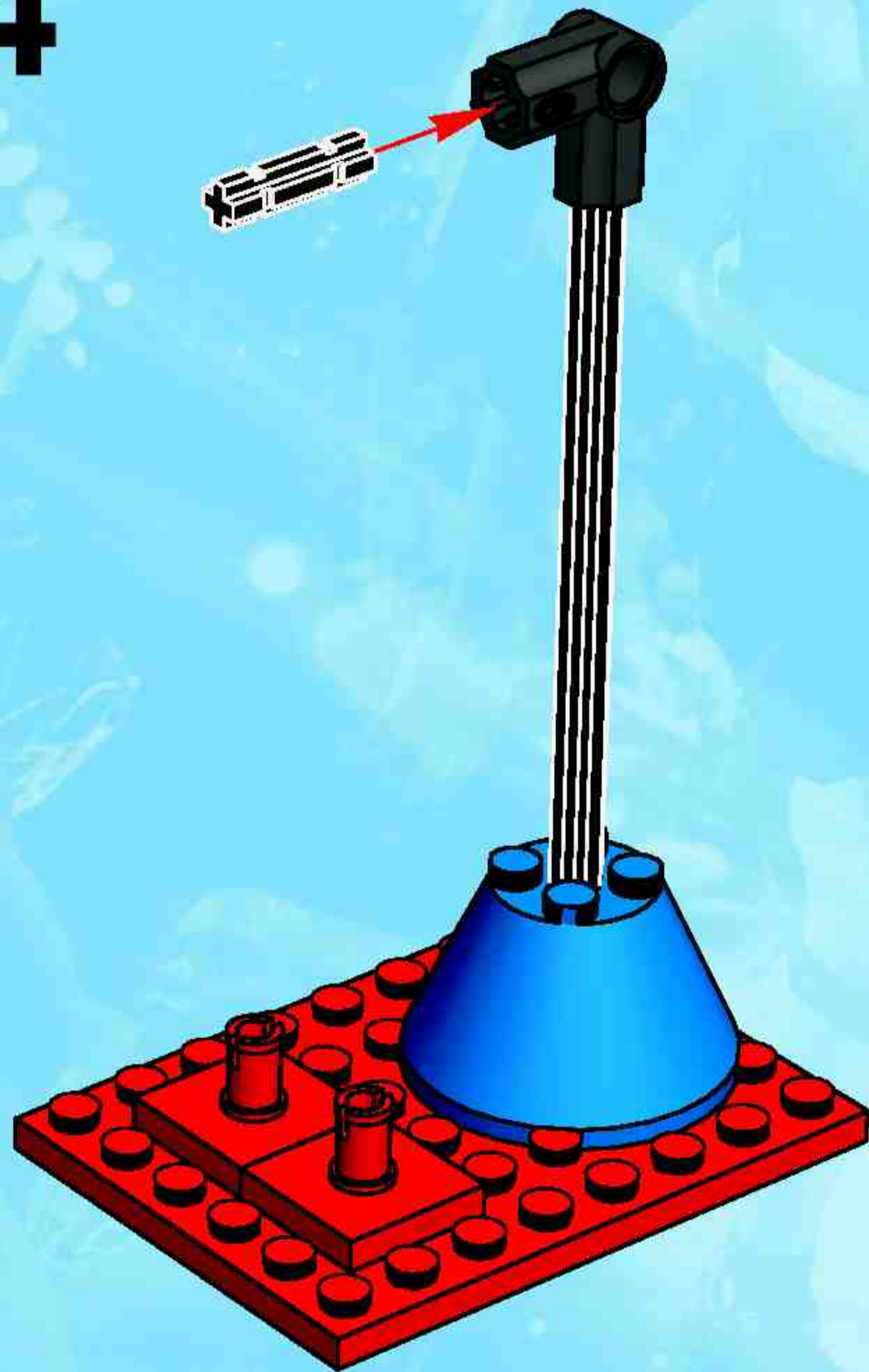

1

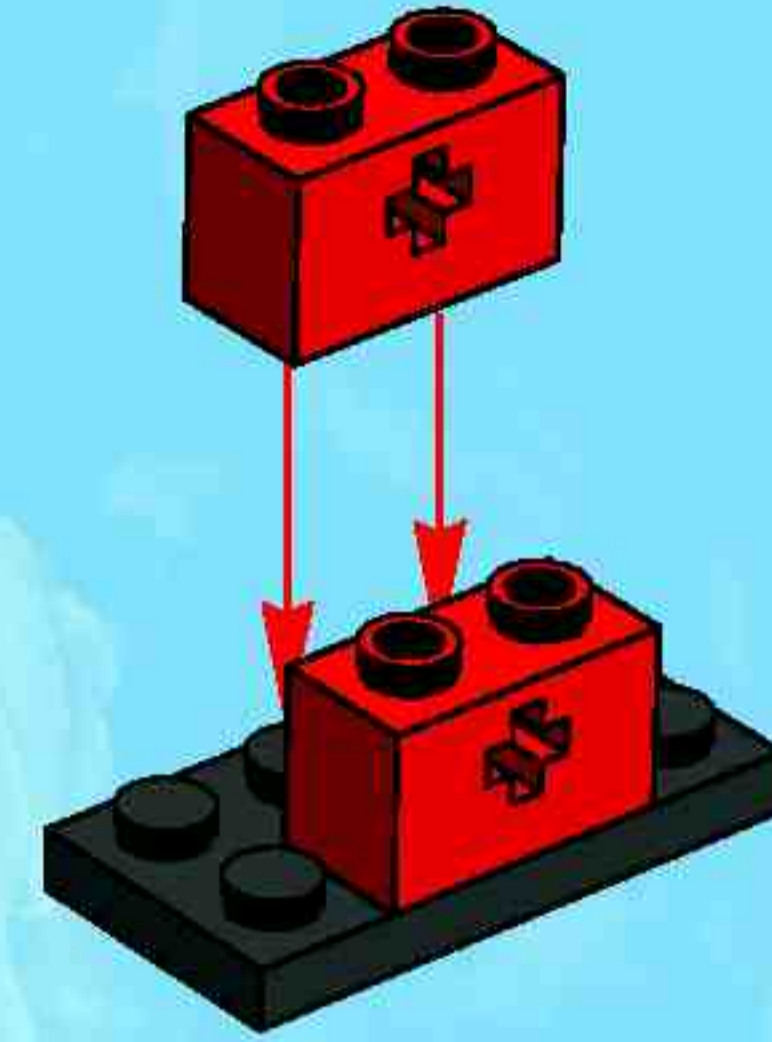

2



3

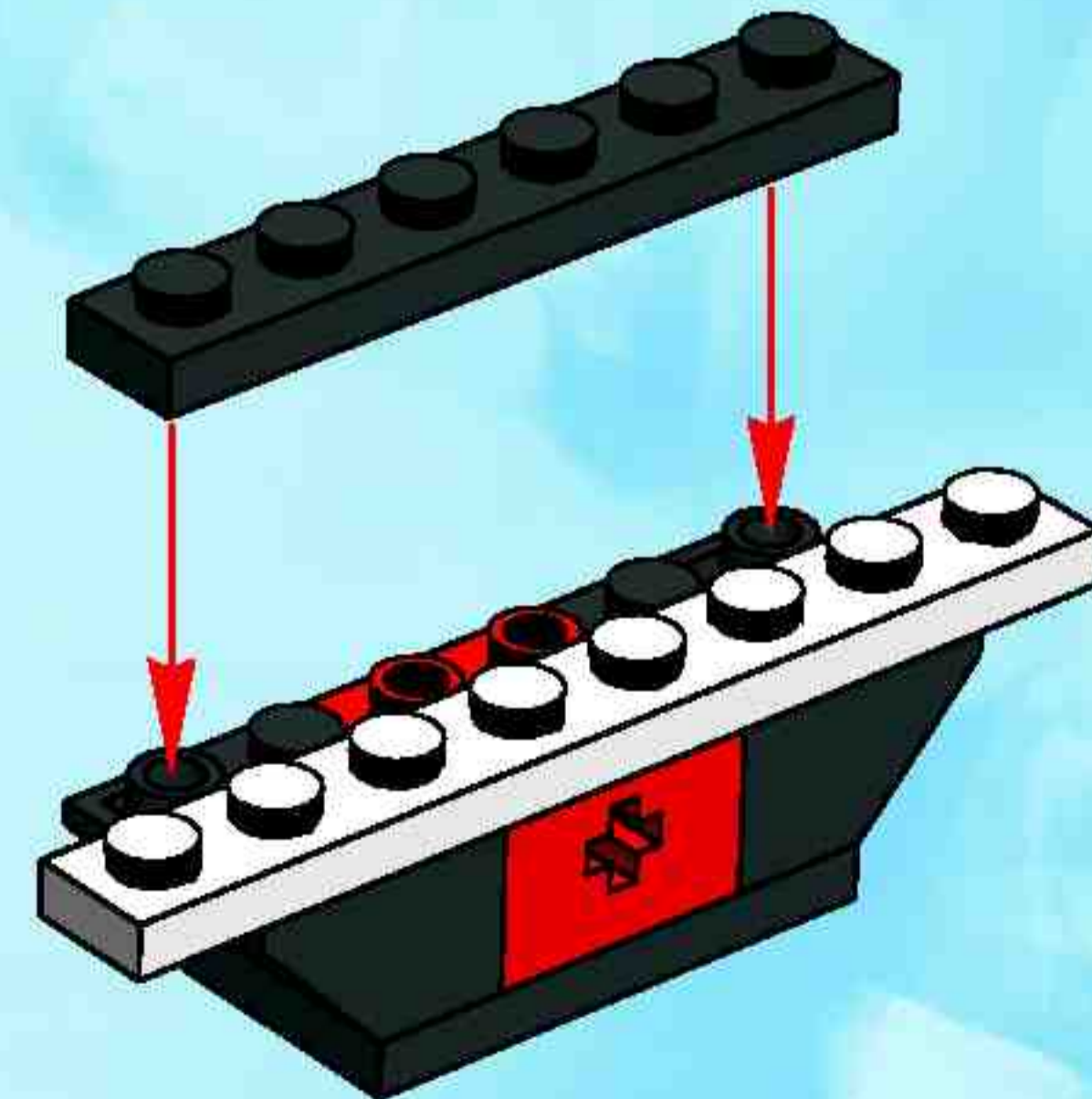

4

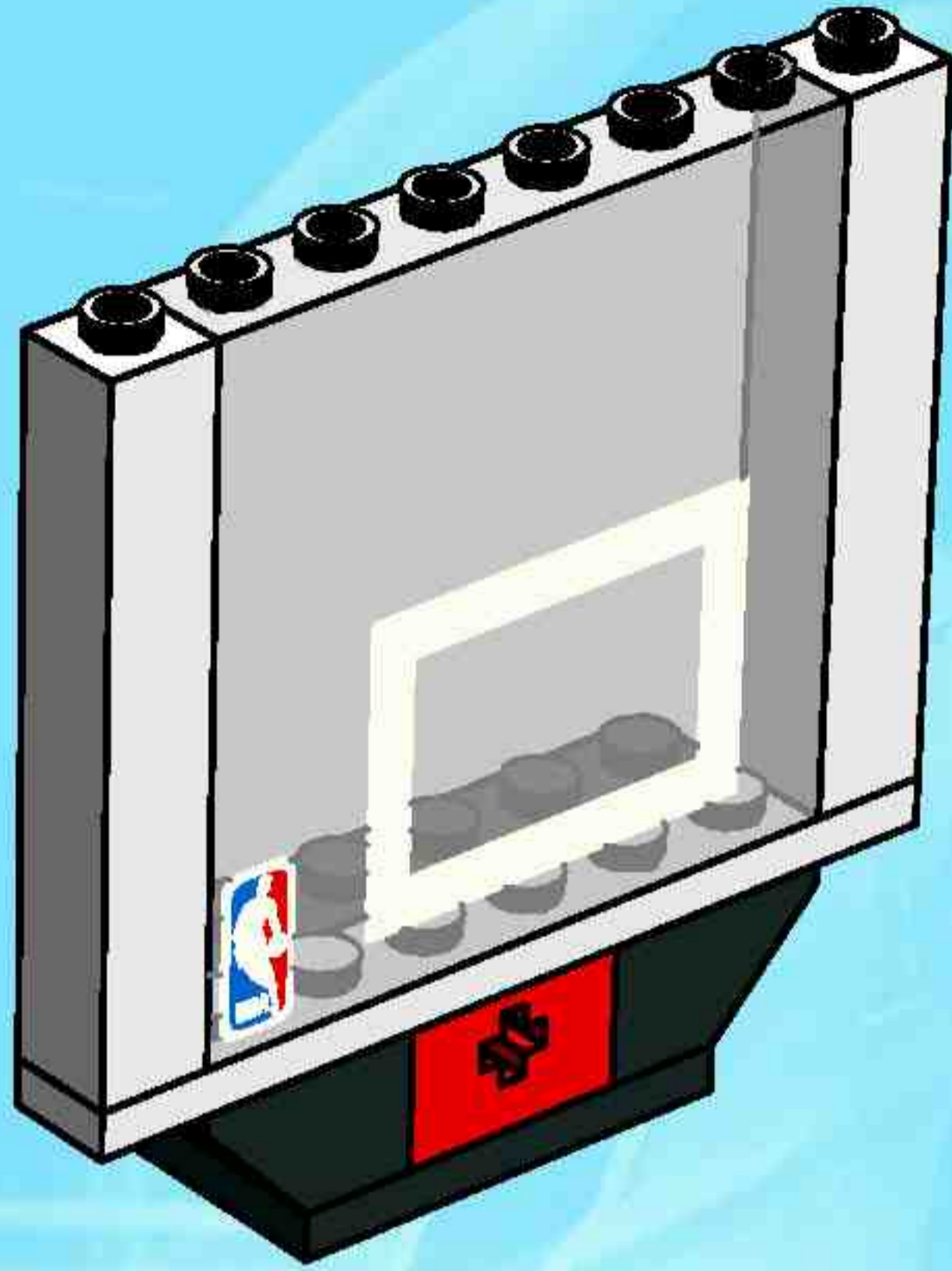

5

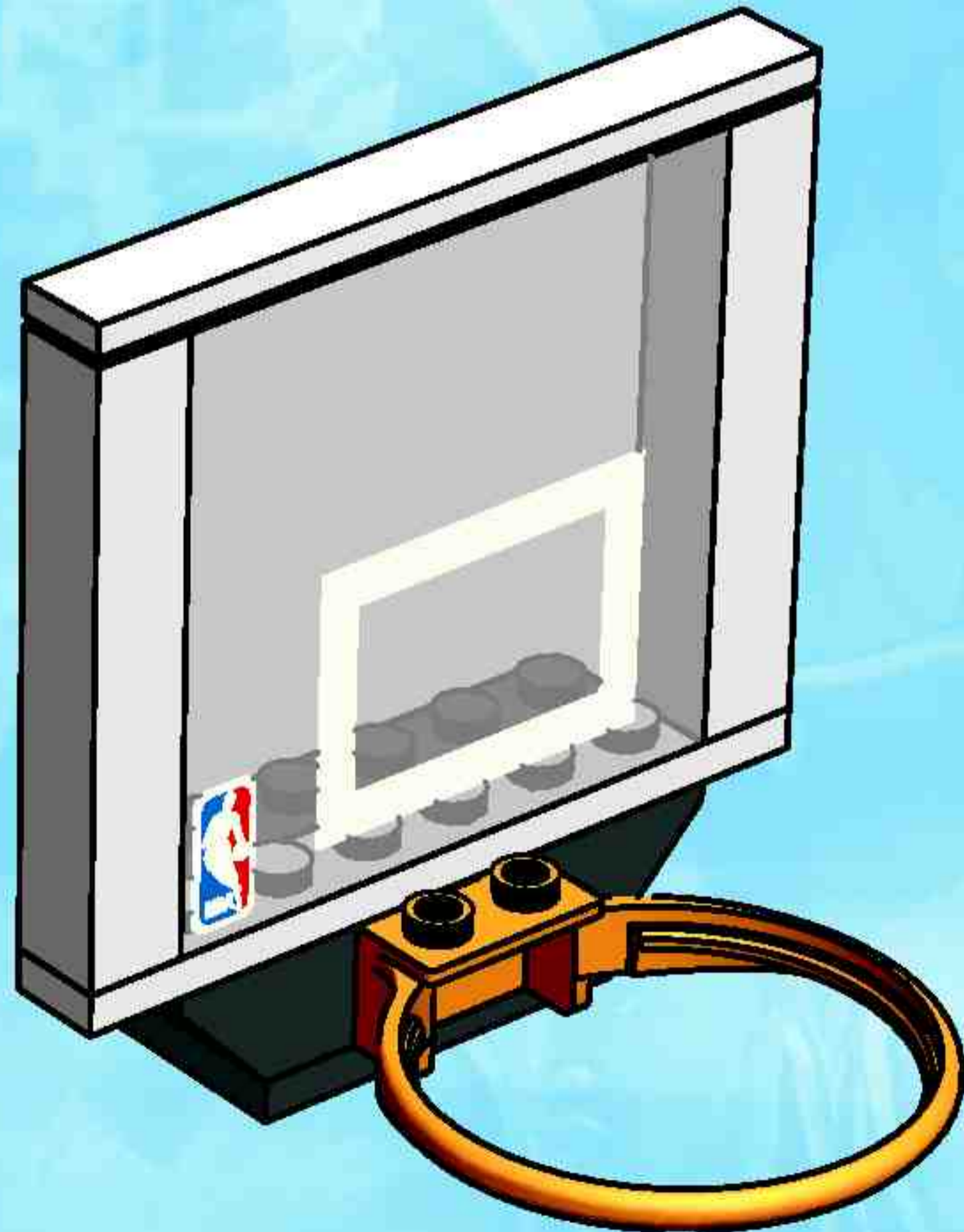

5

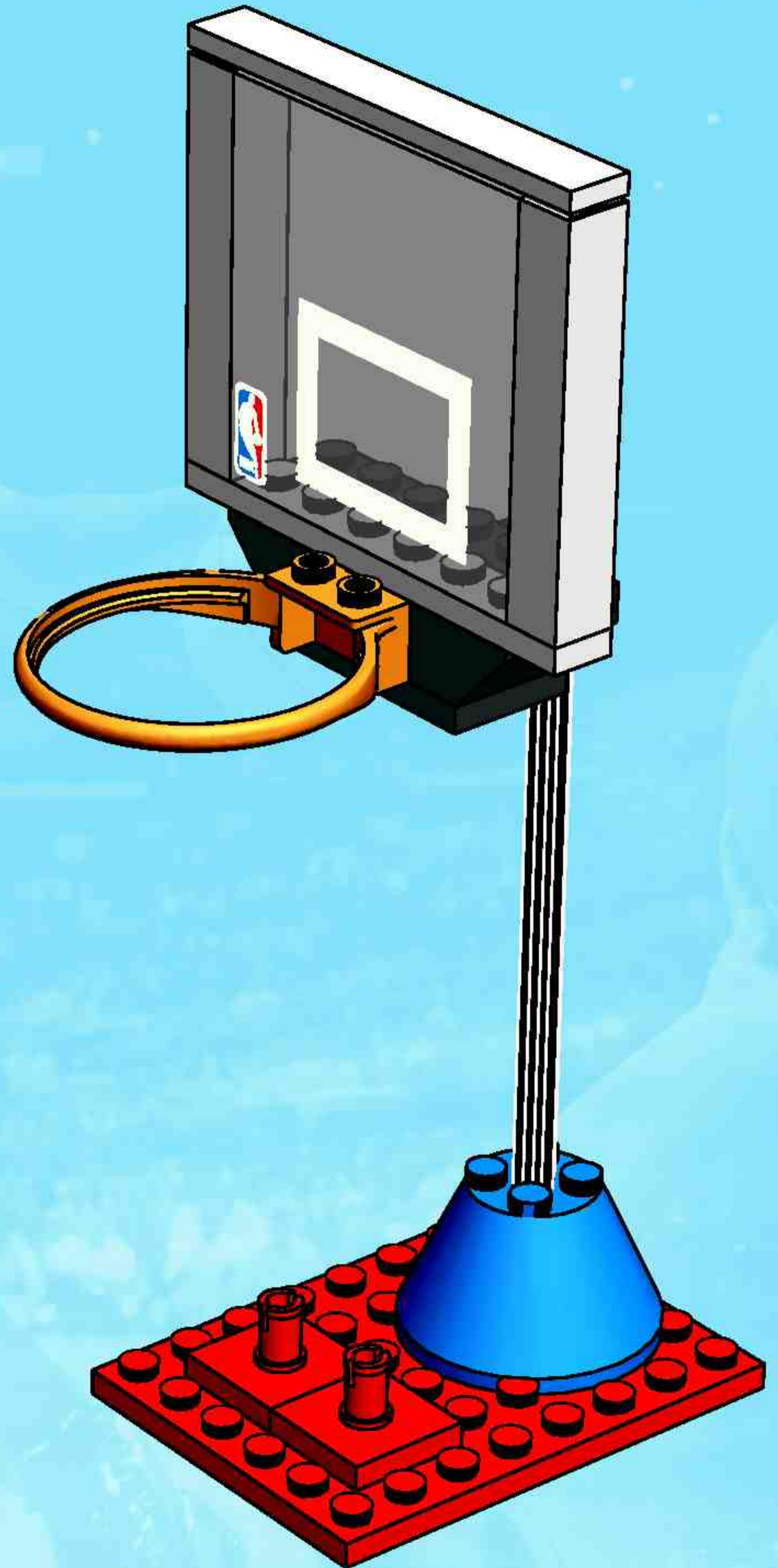

6

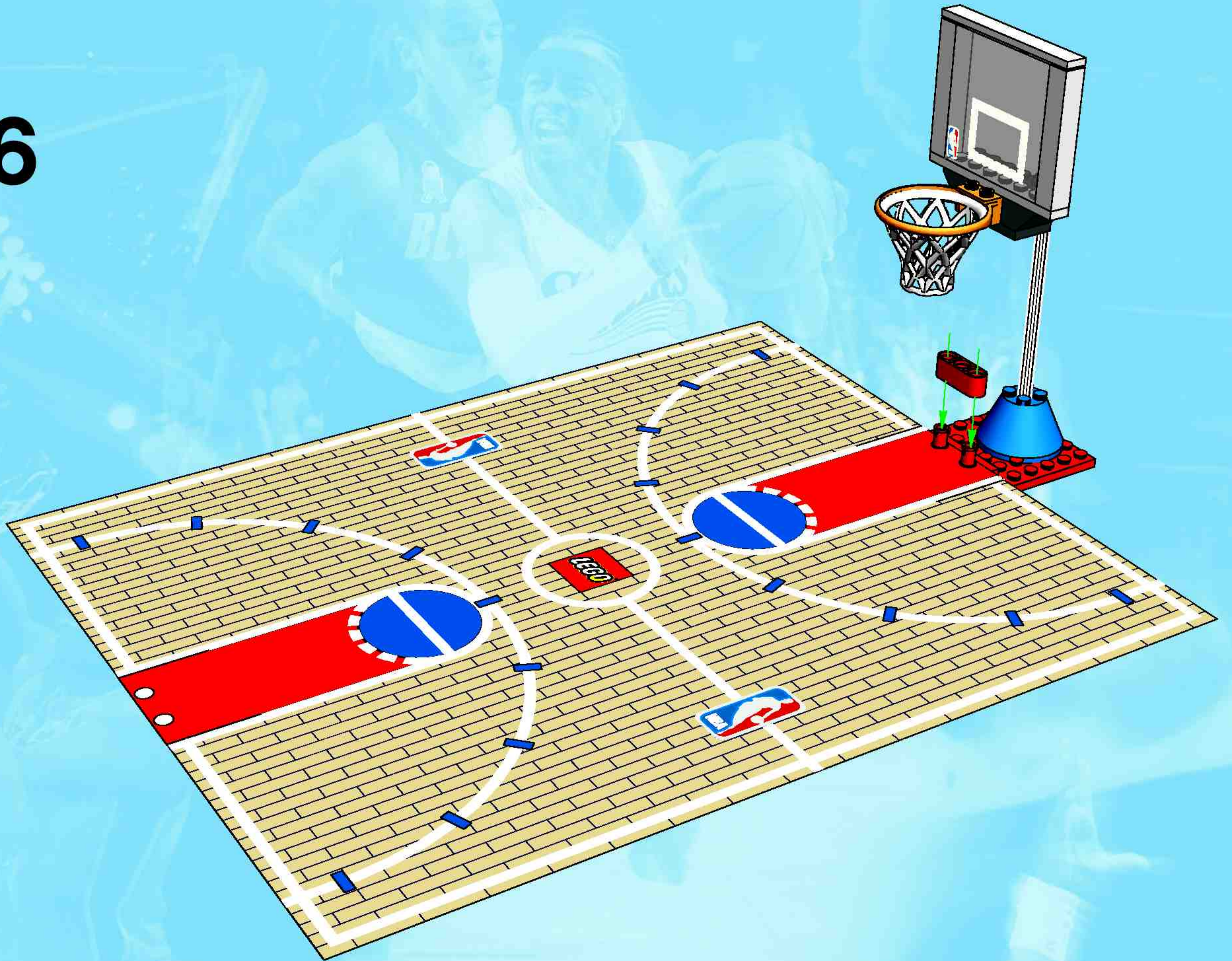

7

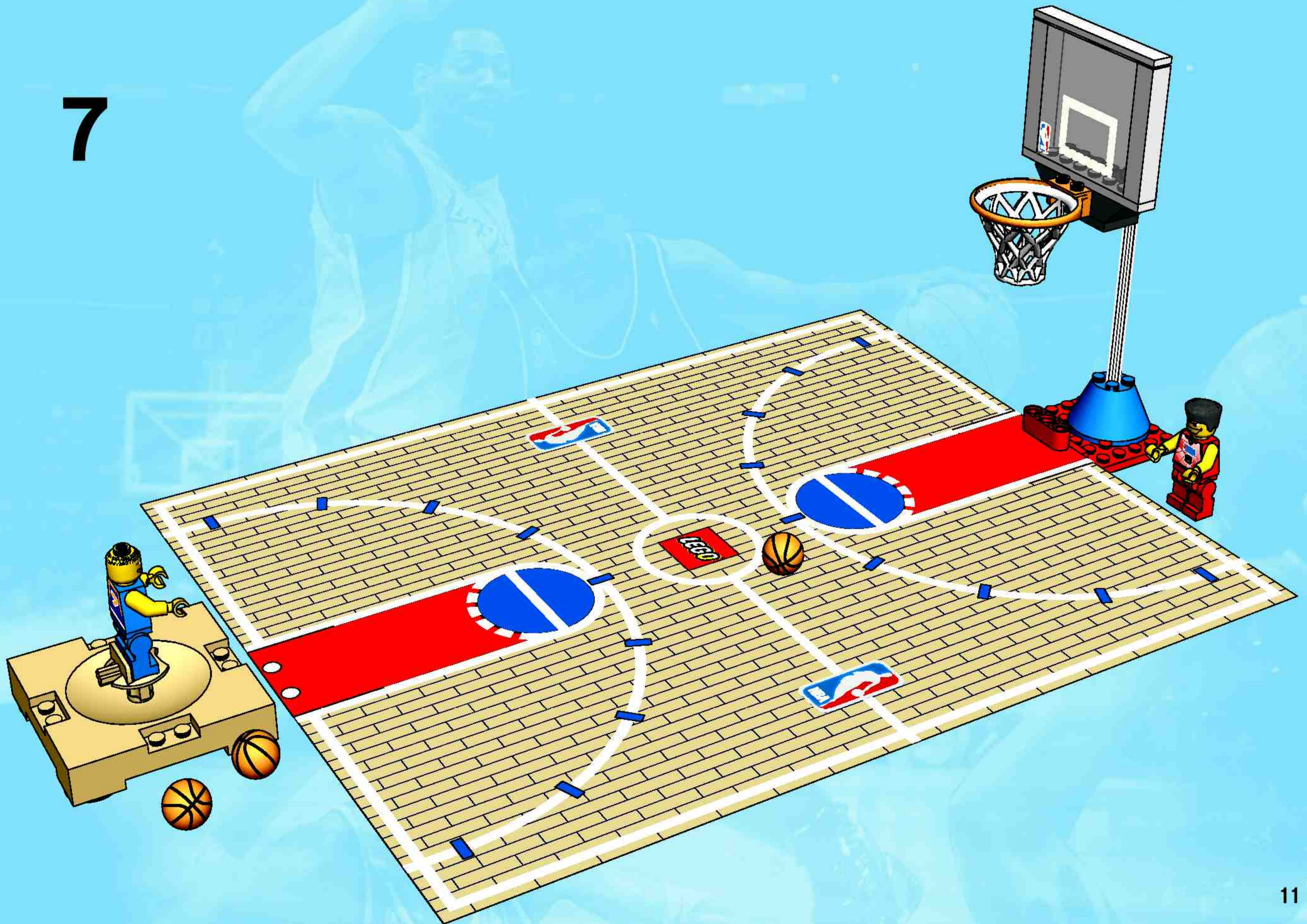



www.LEGO.com

NBA  **.COM**

 **NBA**



#3428

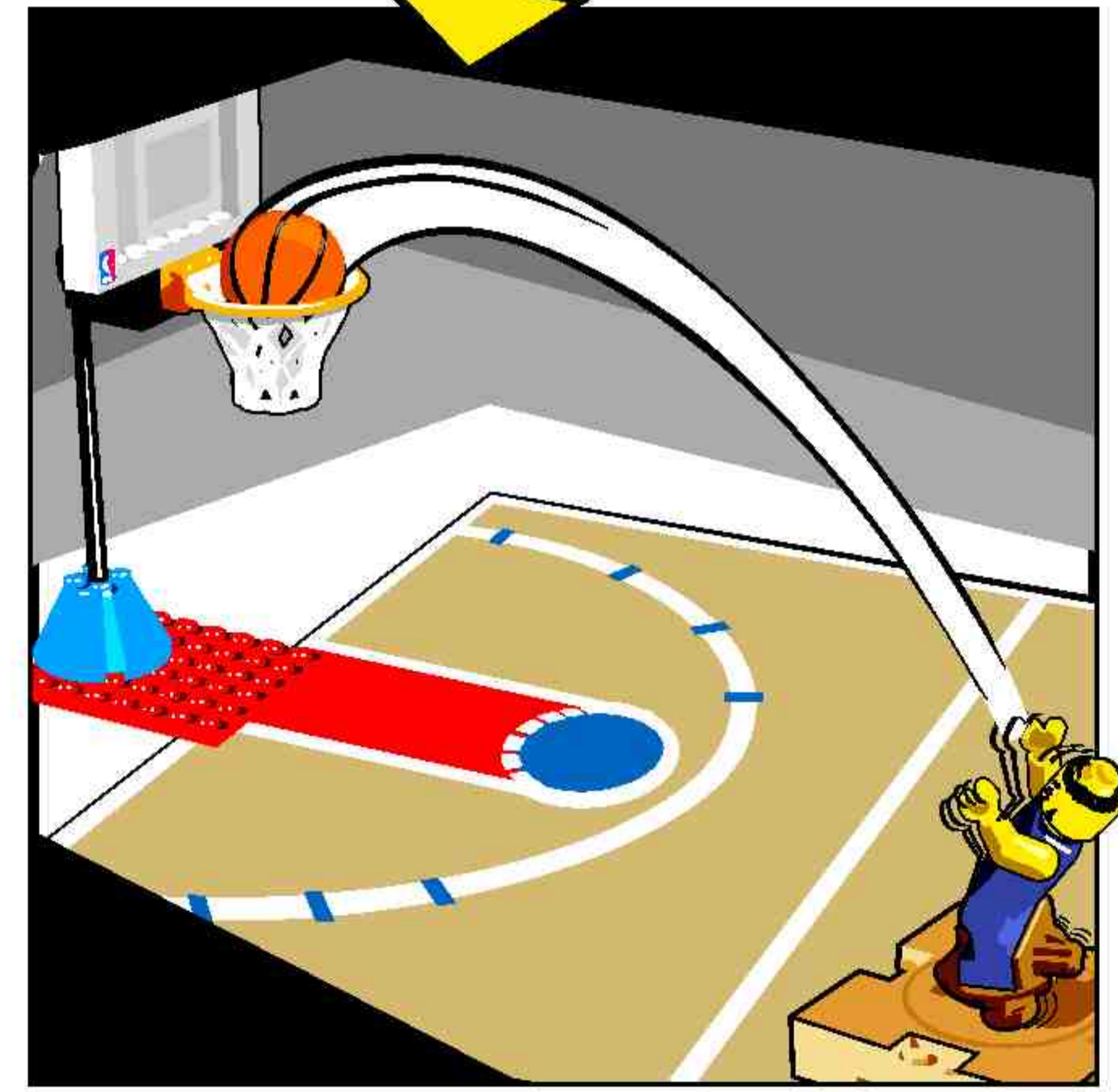

#3427 + #3428



#3428 + #3429



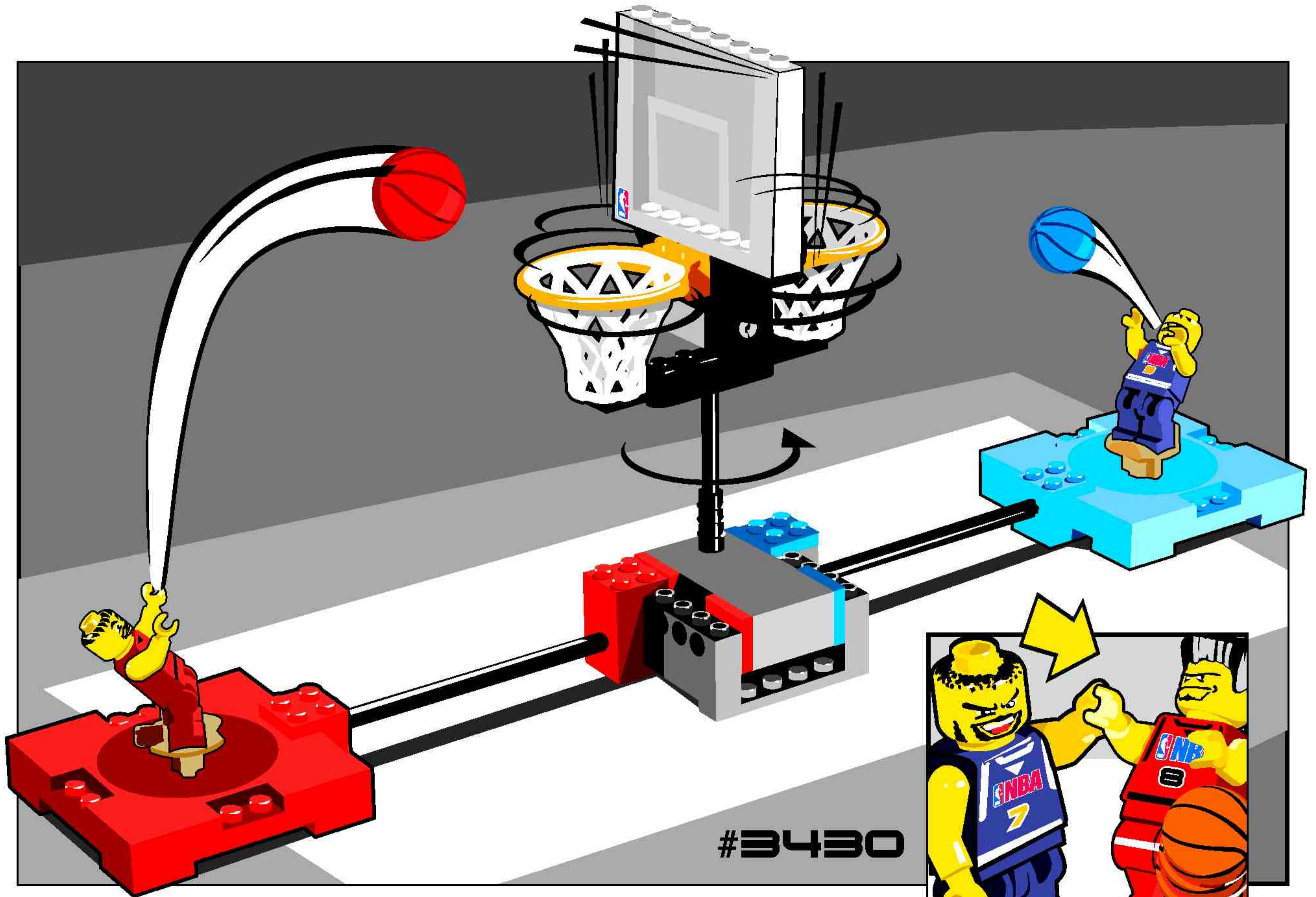

#3430

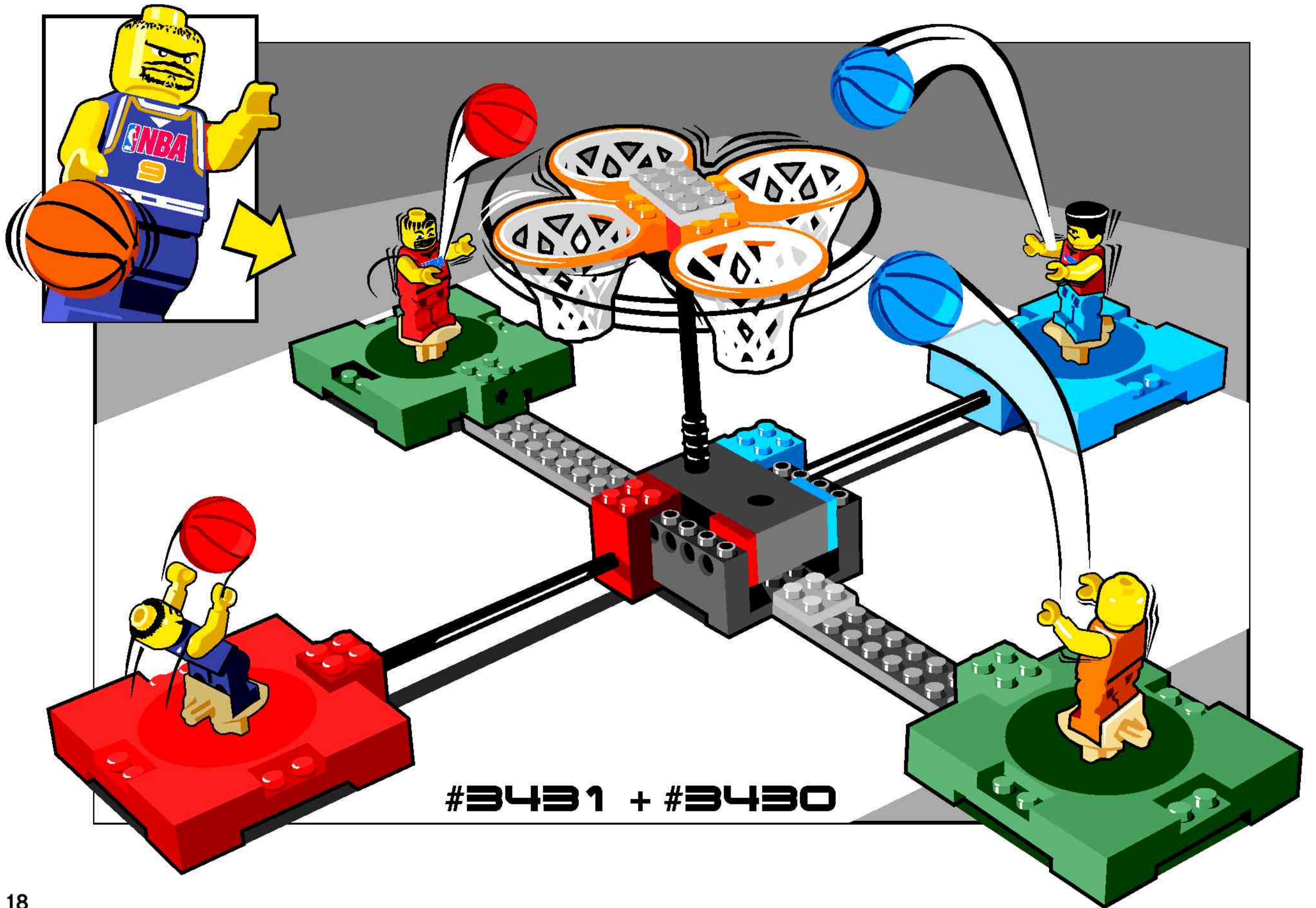



#3431



1

3429+3428

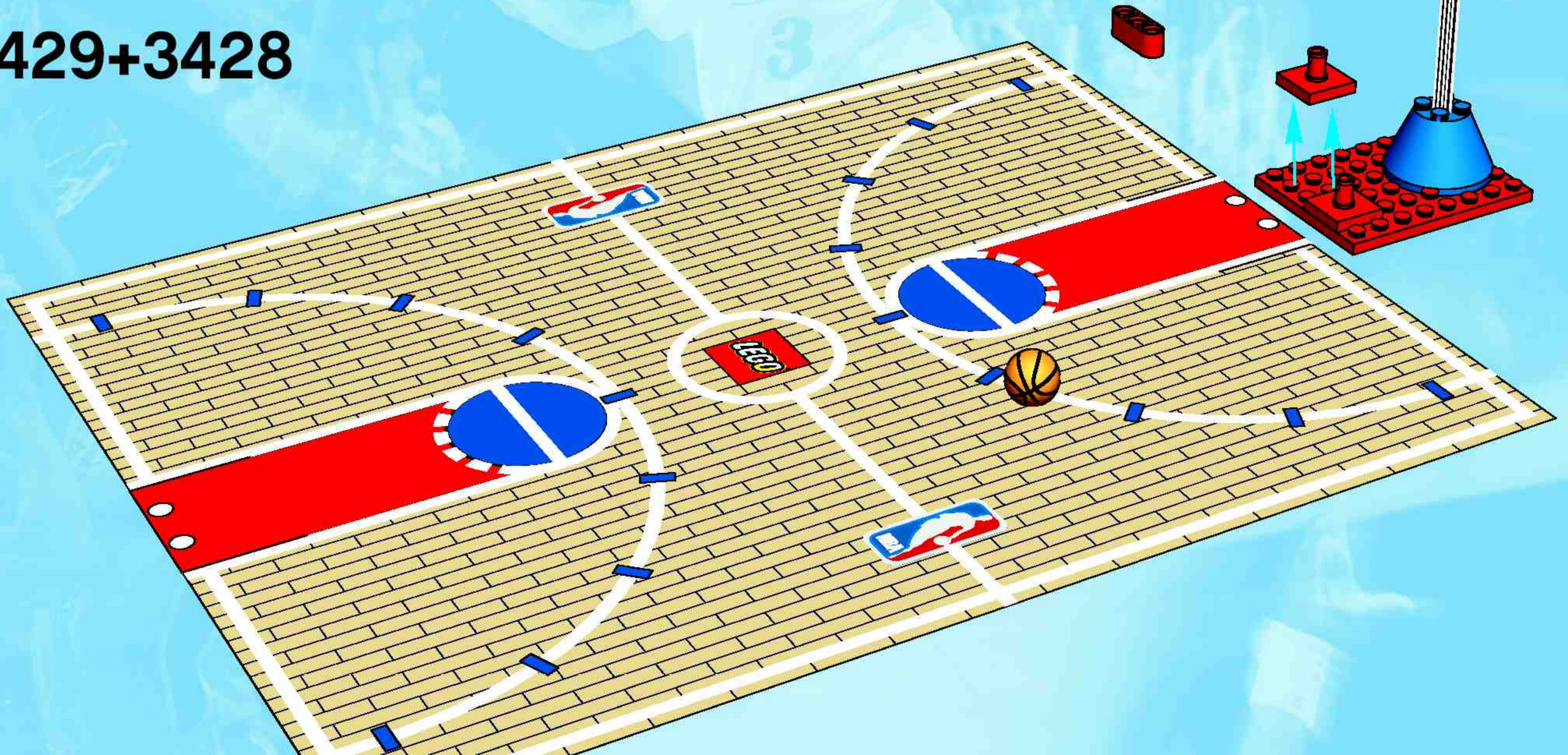

2

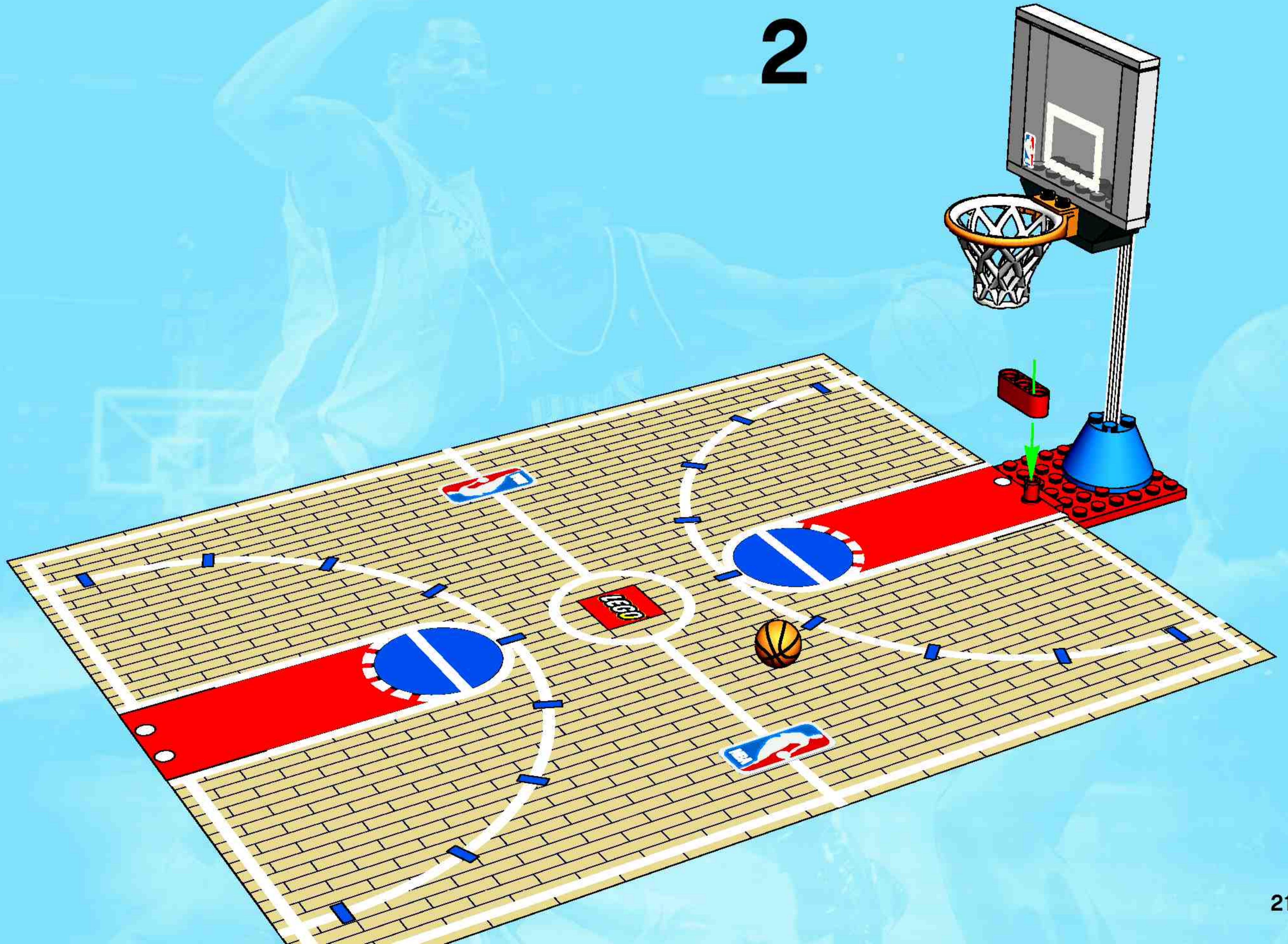



1

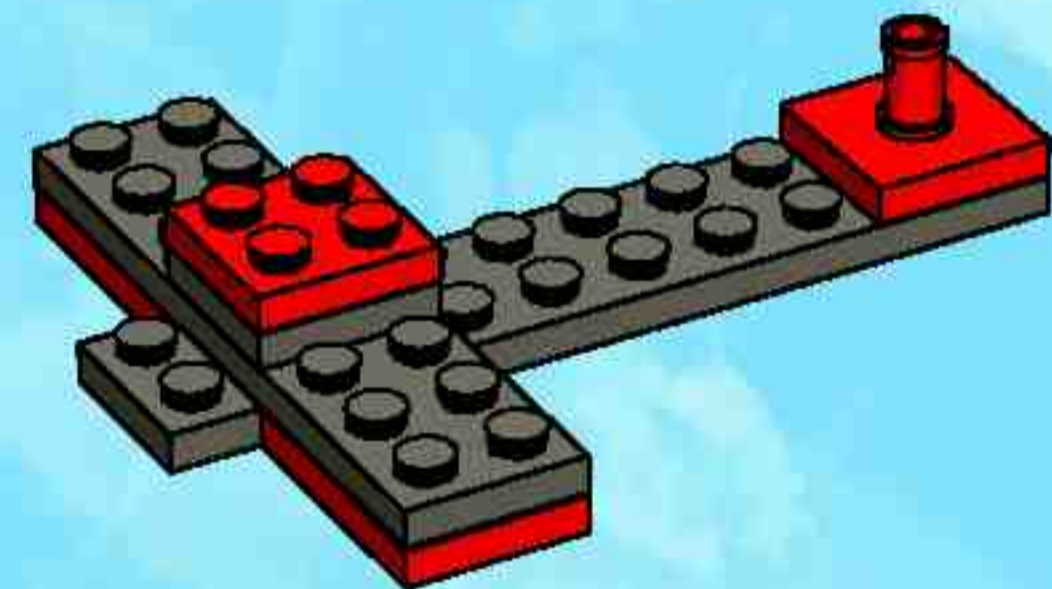

2

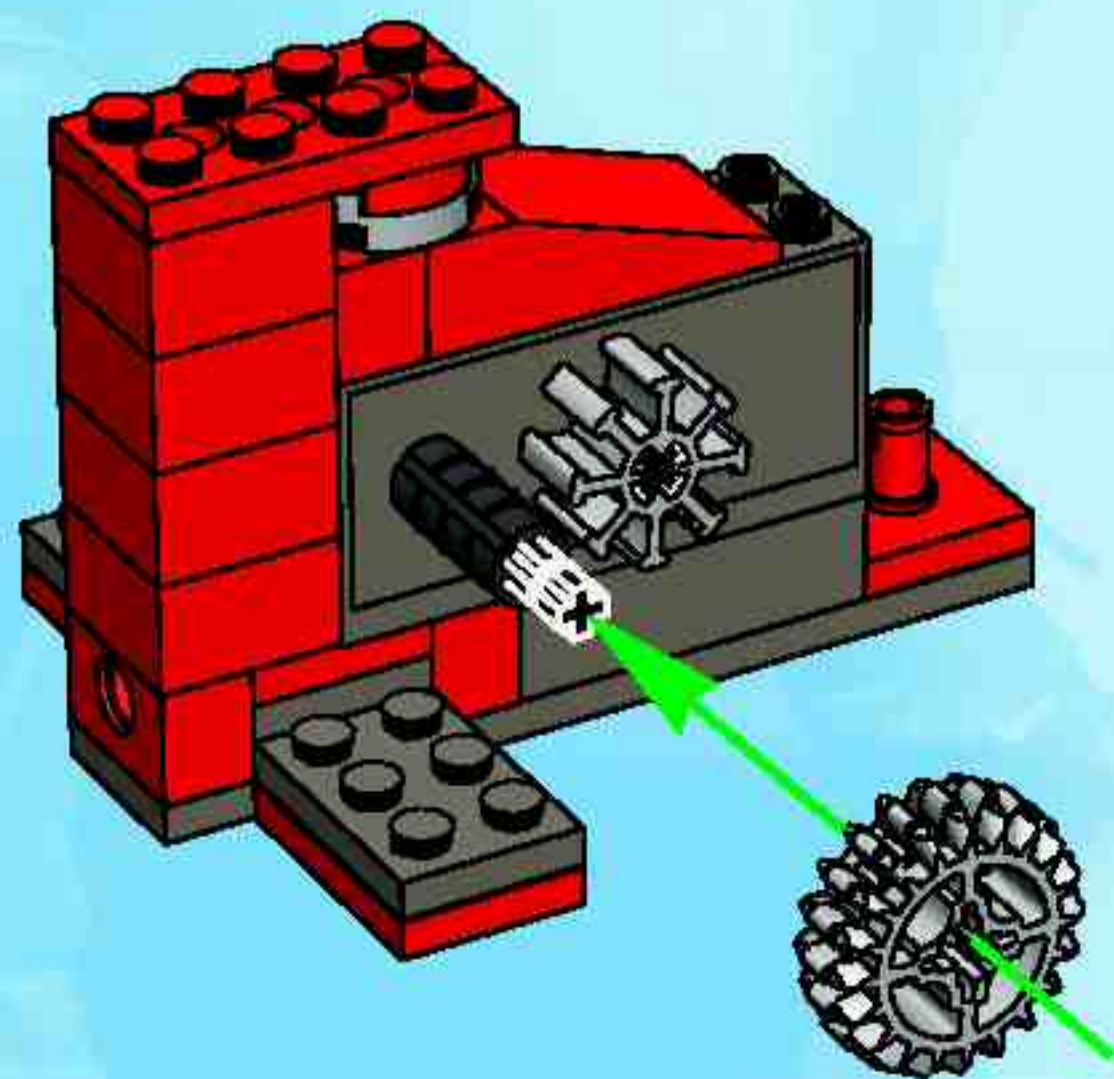

3



3





1



3427+3428

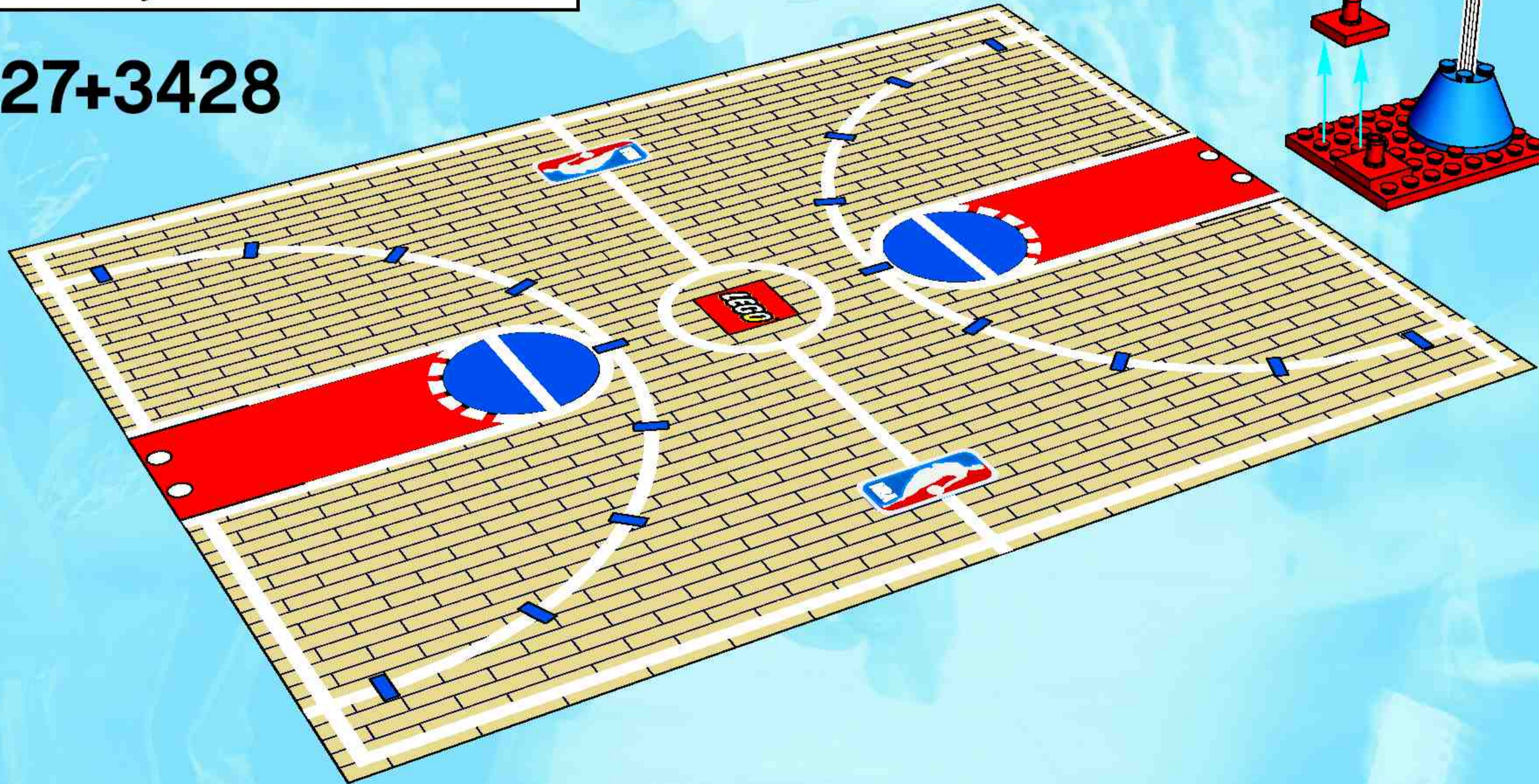

2

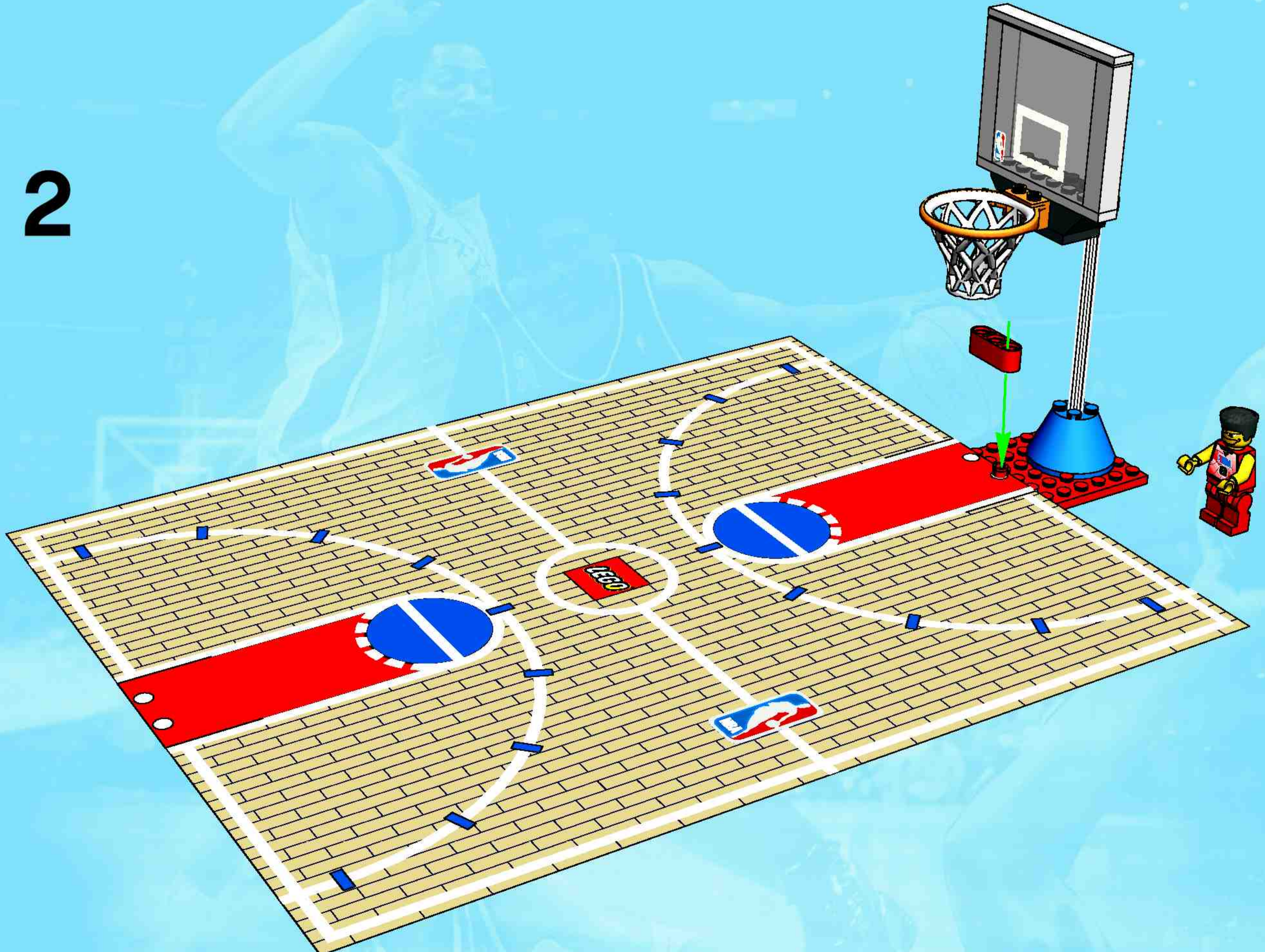

3

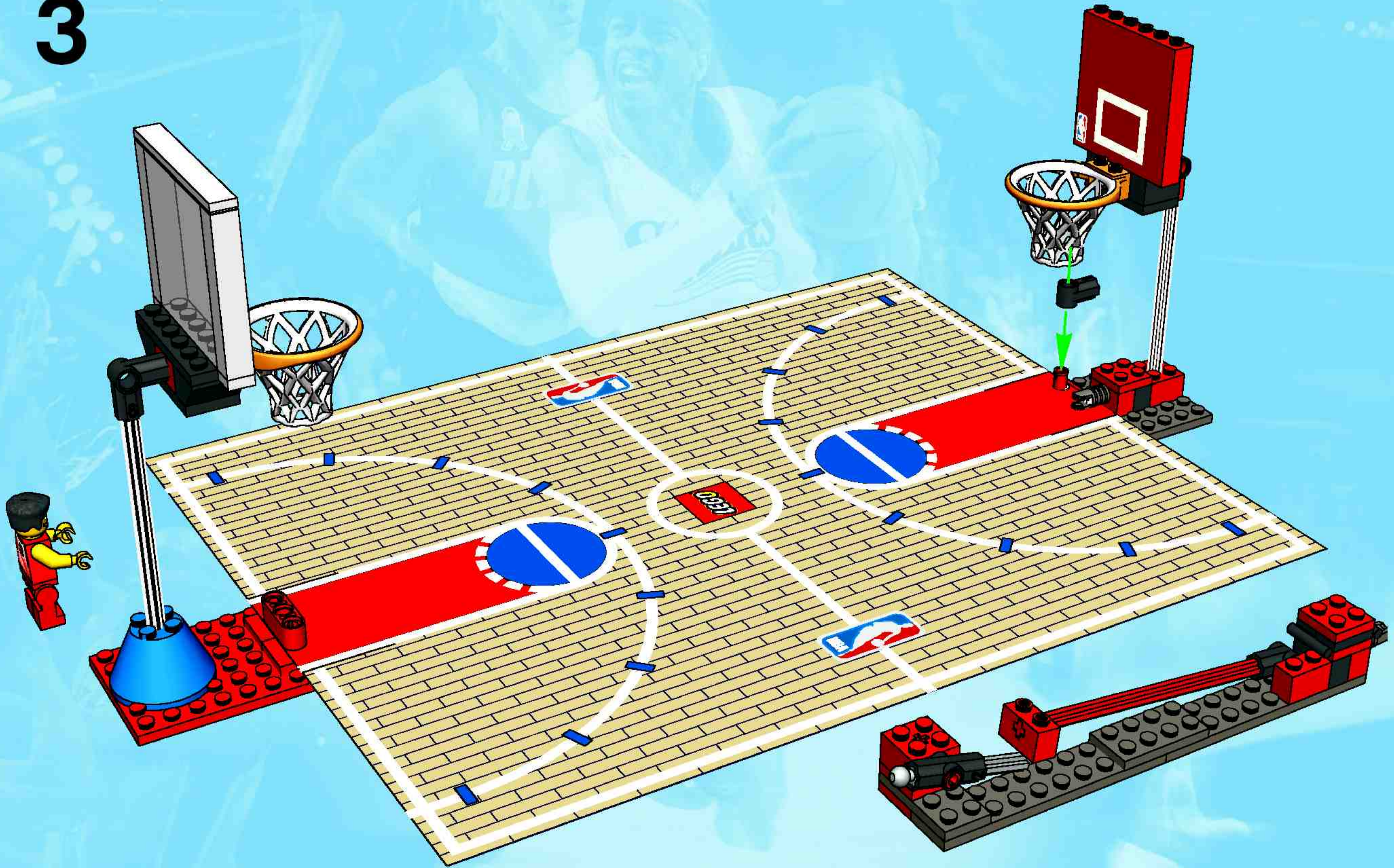

4



LEGO SPORTS



adidas, the adidas logo and the three stripe trademark are registered trademarks of the adidas-Salomon group, used with permission. Fevernova and the Trigon logo are trademarks of the adidas-Salomon group, used with permission.

 www.LEGO.com

SPALDING is a trademark of Spalding Sports Worldwide, Inc. or Lisco Sports, Inc., a Spalding affiliate. © Spalding Sports Worldwide, Inc. 2002

NBA identifications depicted are the exclusive property of NBA Properties, Inc. and/or the NBA Member Teams, and are used with permission.

LEGO and the LEGO logo are trademarks of the LEGO Group. ©2002 The LEGO Group.

