



Friends



3315



WARNING: CHOKING HAZARD.
Toy contains small parts and a small ball.
Not for children under 3 years.

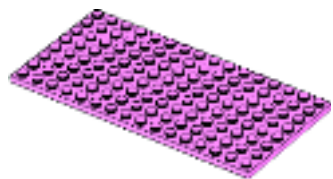

+

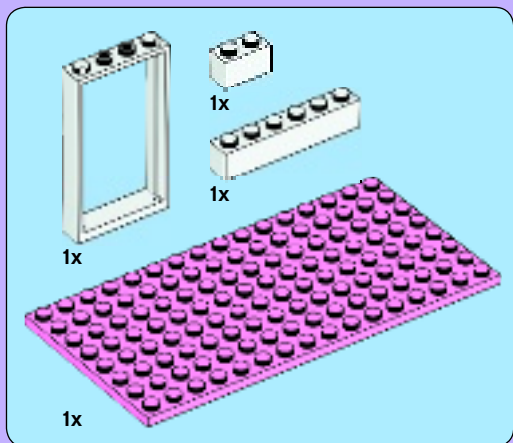

1

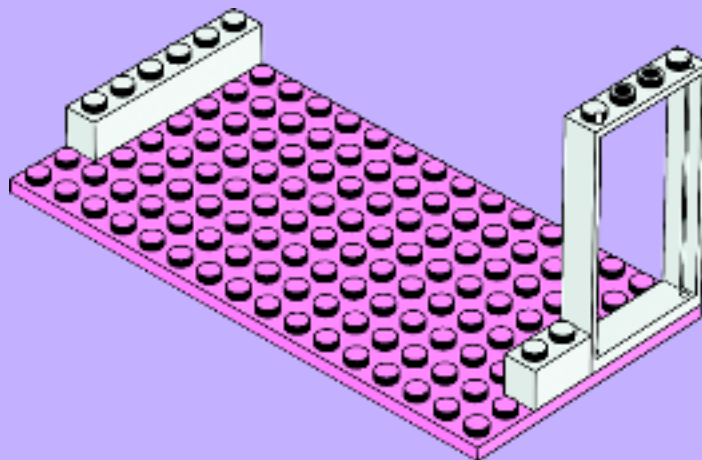

AVERTISSEMENT : RISQUE D'ÉTOUFFEMENT.

Le jouet contient des petites pièces ainsi qu'une petite boule.
Il ne convient pas aux enfants de moins de 3 ans.



ADVERTENCIA: PELIGRO DE ASFIXIA.

Juguete que contiene partes pequeñas y una pelota pequeña.
No recomendado para niños menores de 3 años.



2x



2x

2

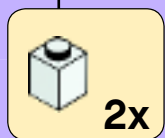
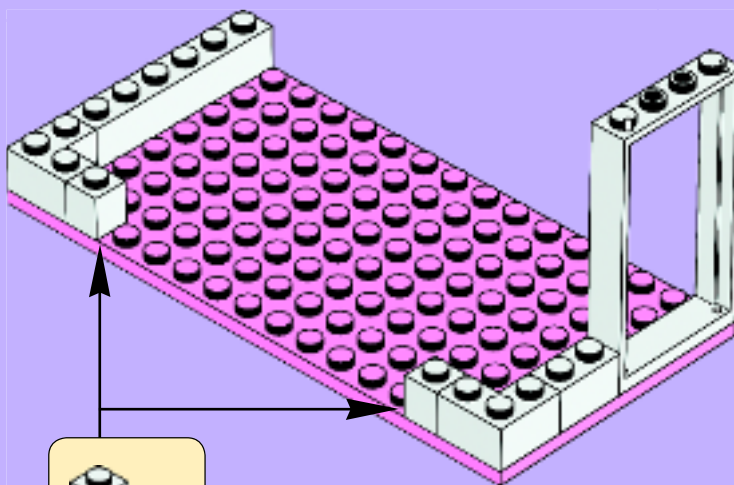

2x

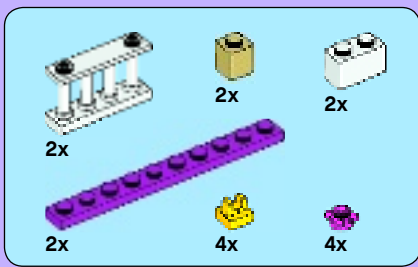

3

1

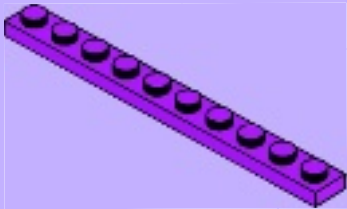

2

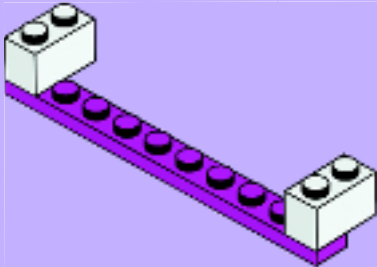

3

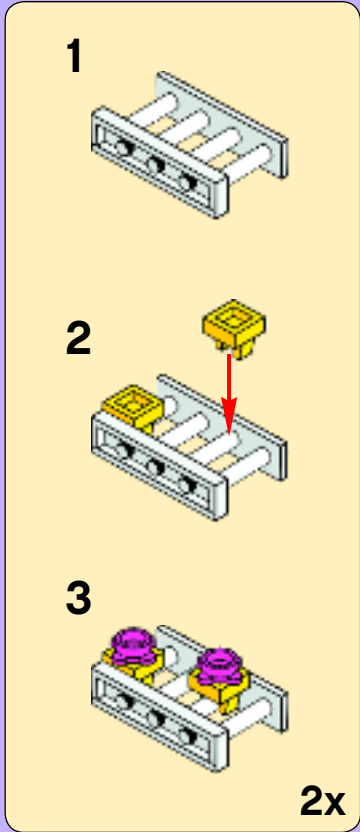
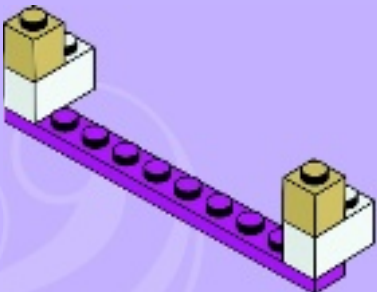

4

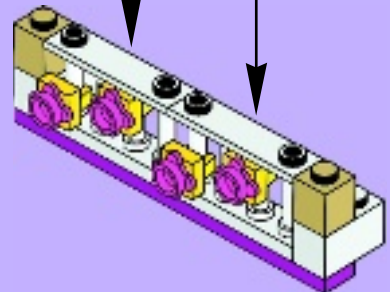

5

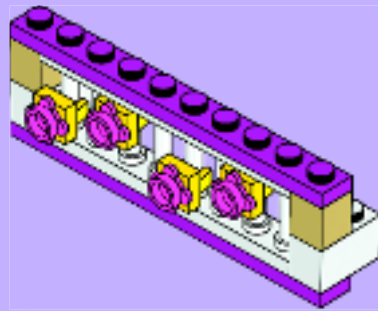

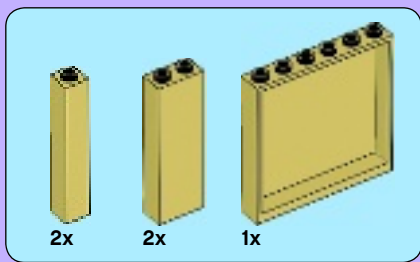

4

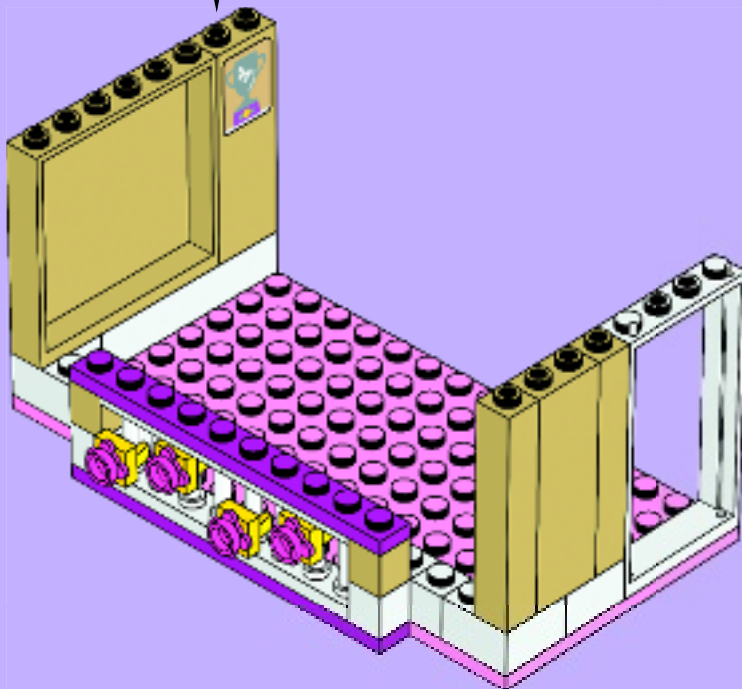
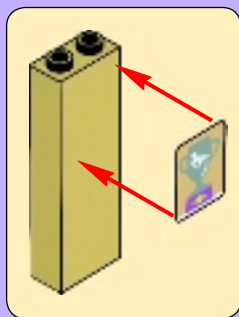

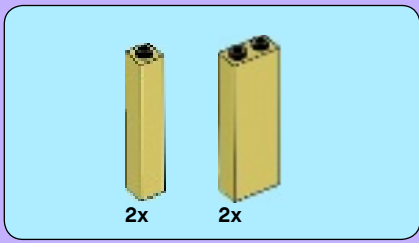

5

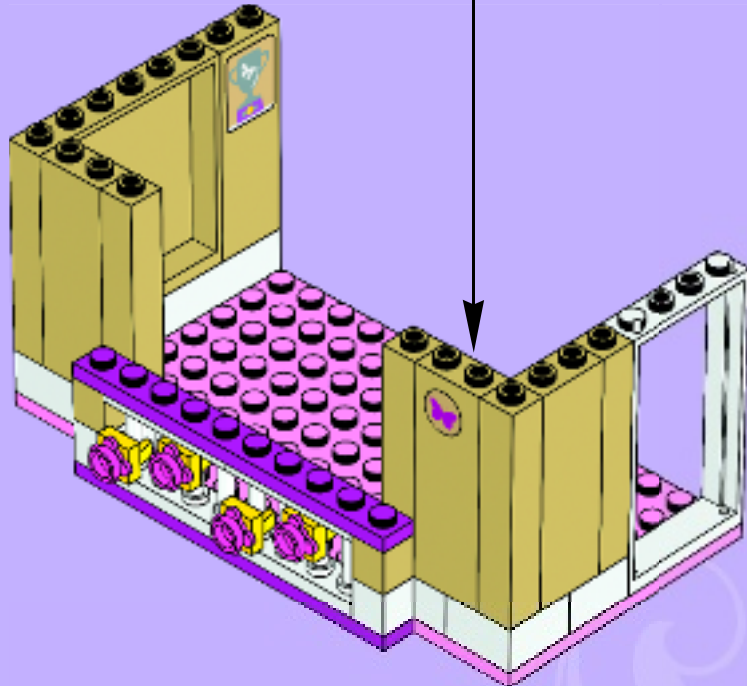
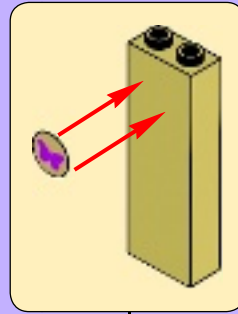

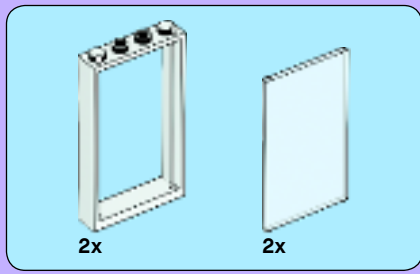

6

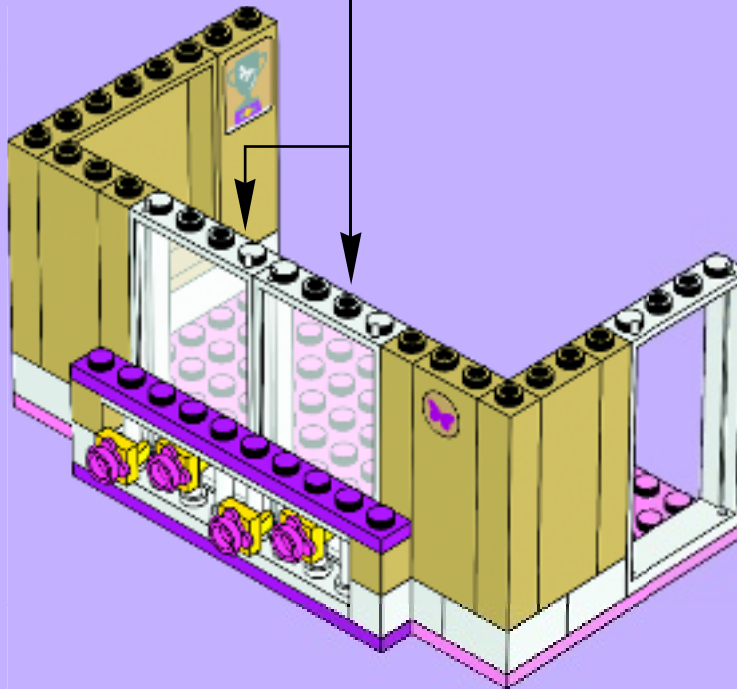
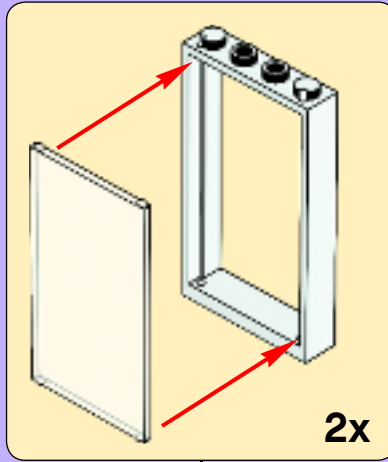

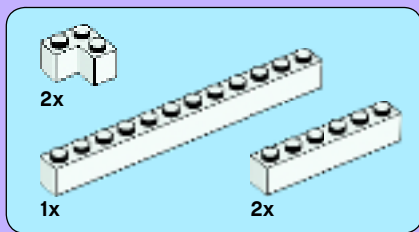

7



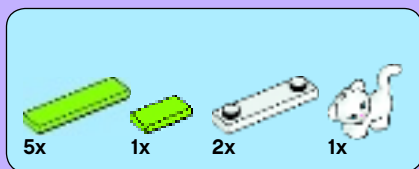

8

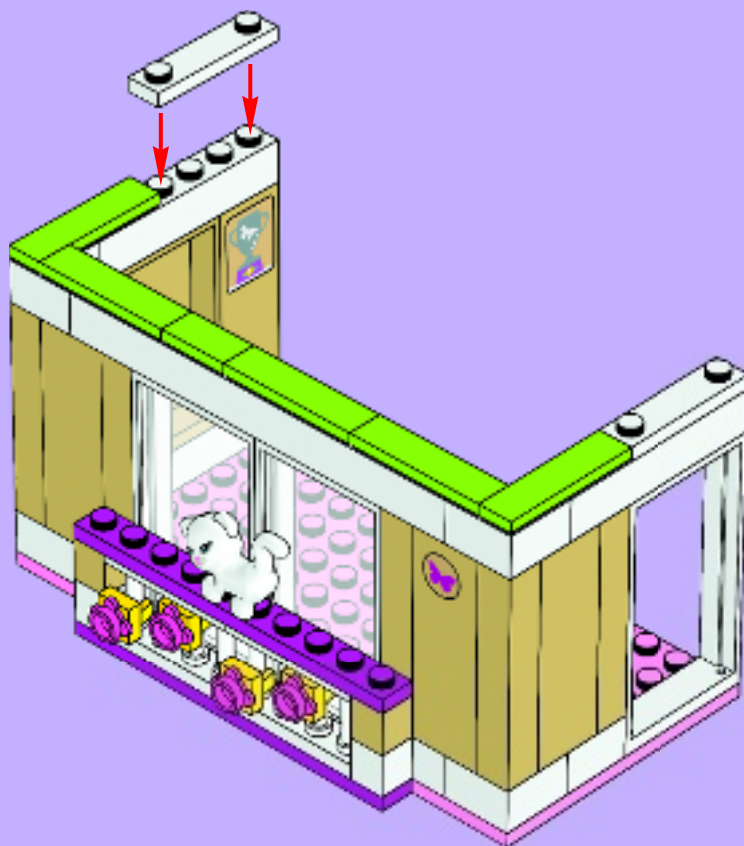

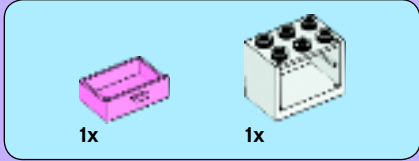
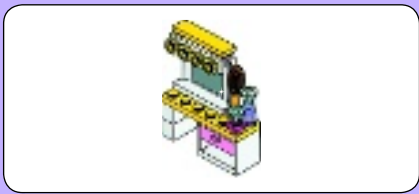

1

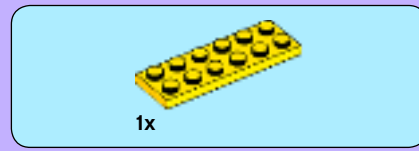
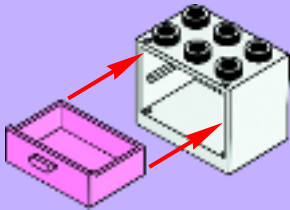

2

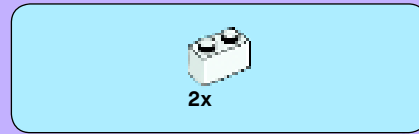

3

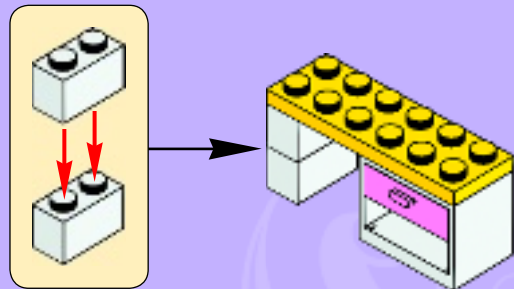



4

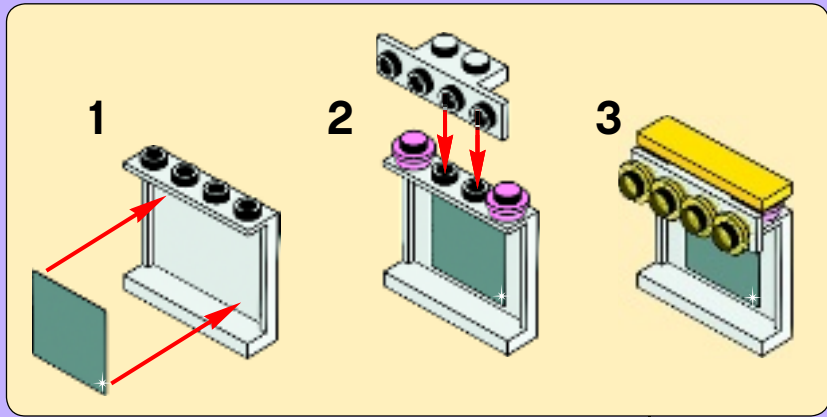

5



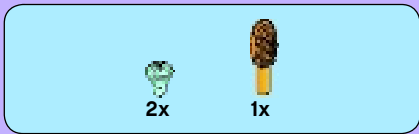

6

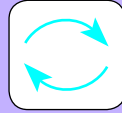

9





1x



1x

10

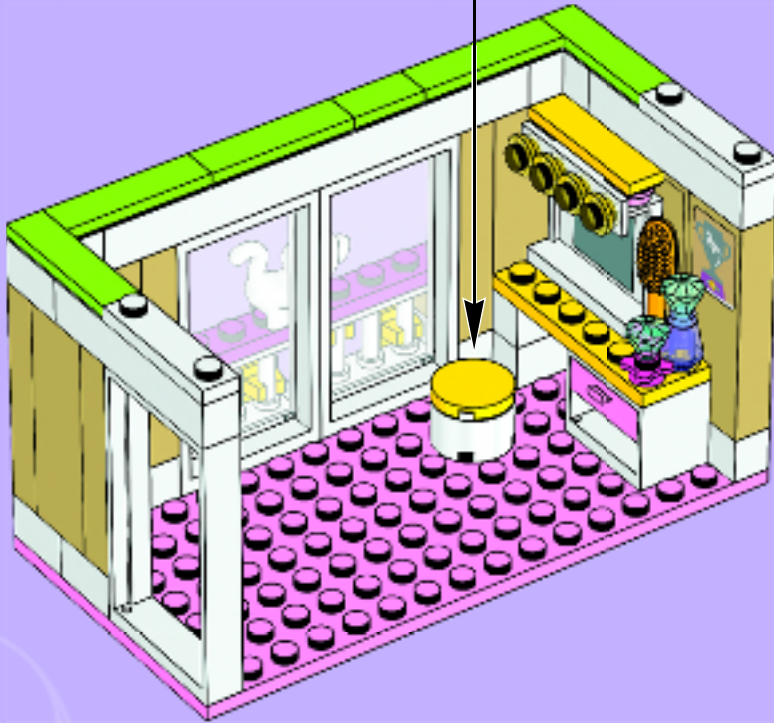
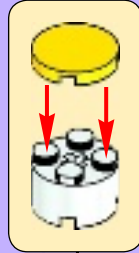

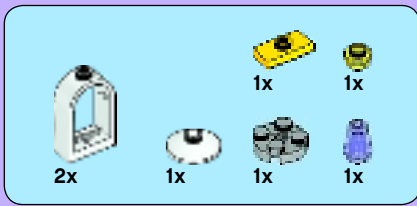

11

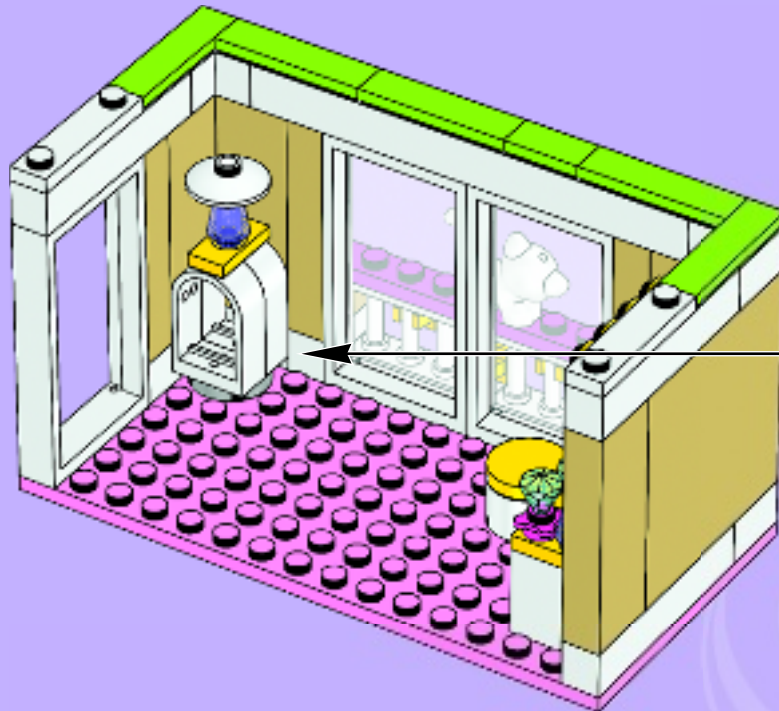
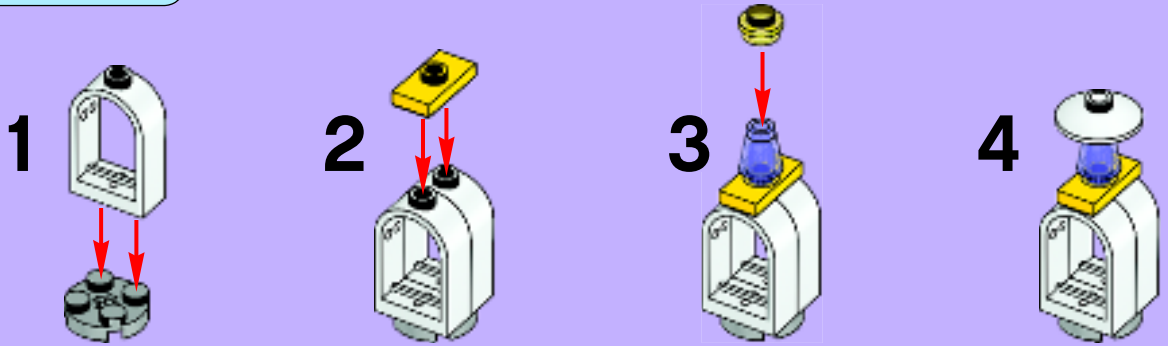

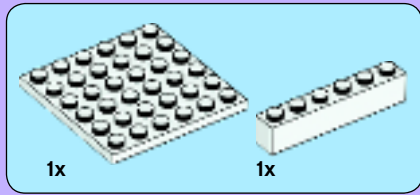

1

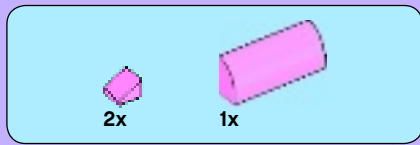

2

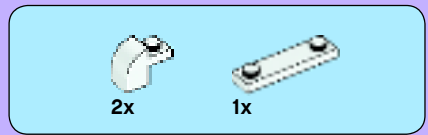
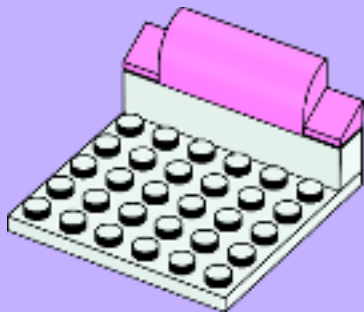

3

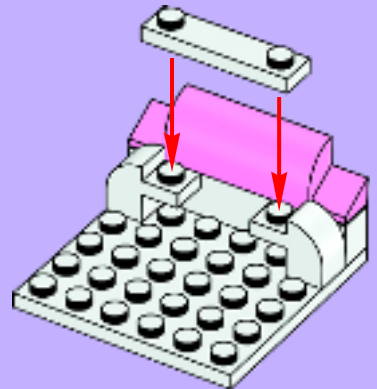

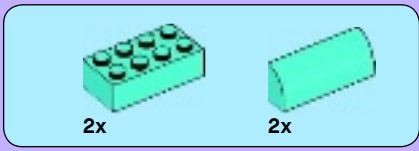

4

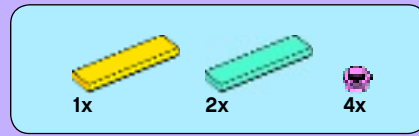
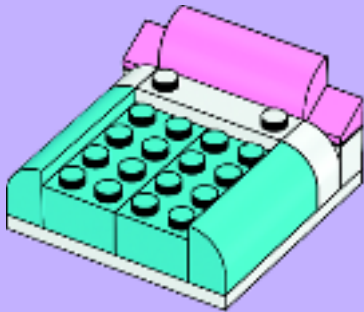

5





2x

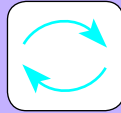

6

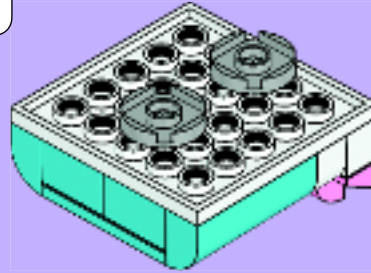

12





13

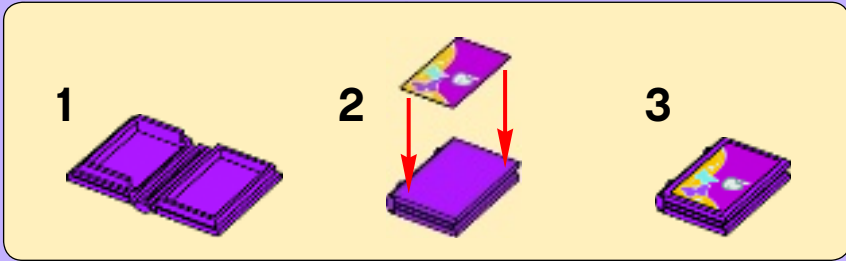



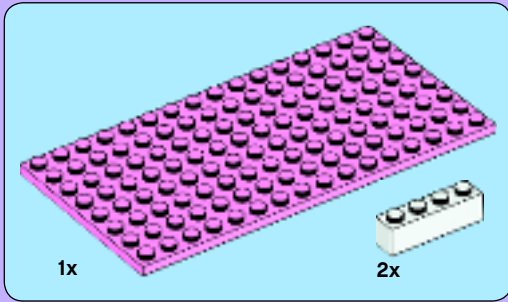
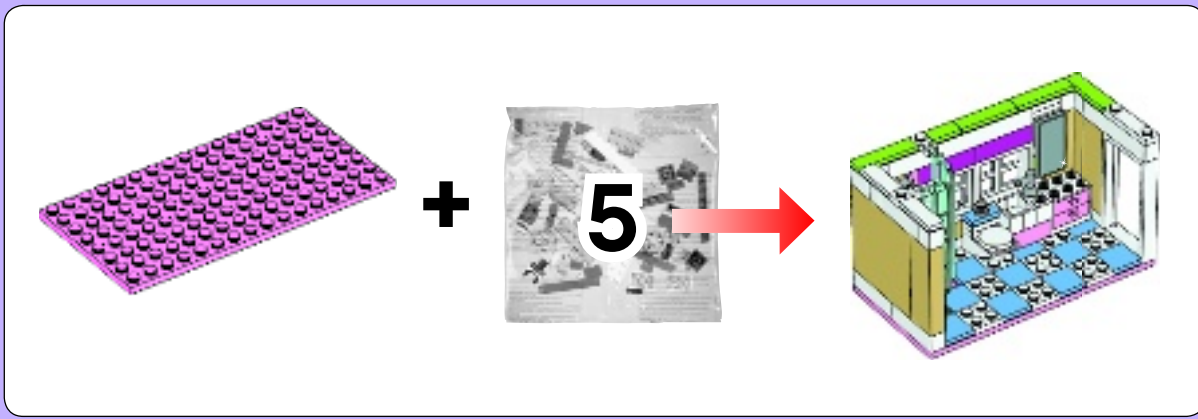

1

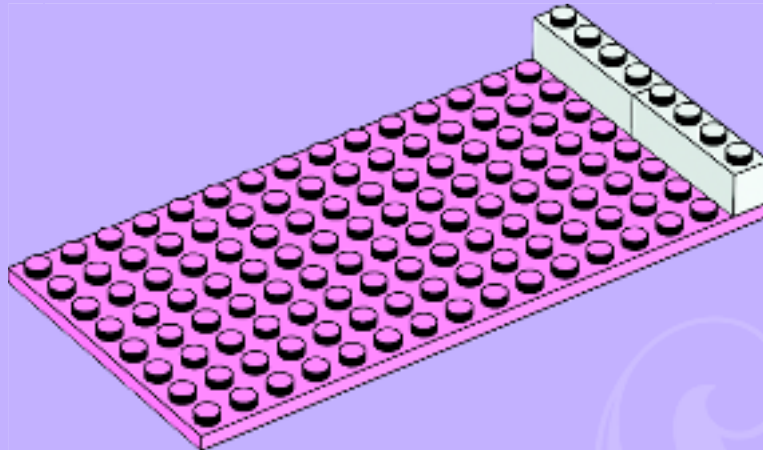

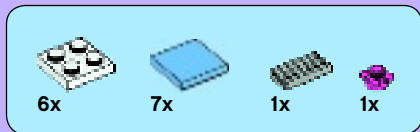

2

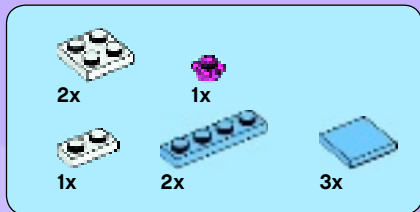
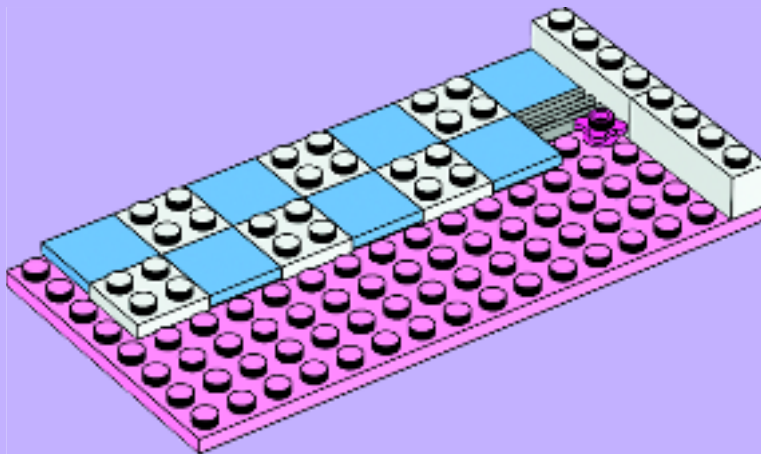

3

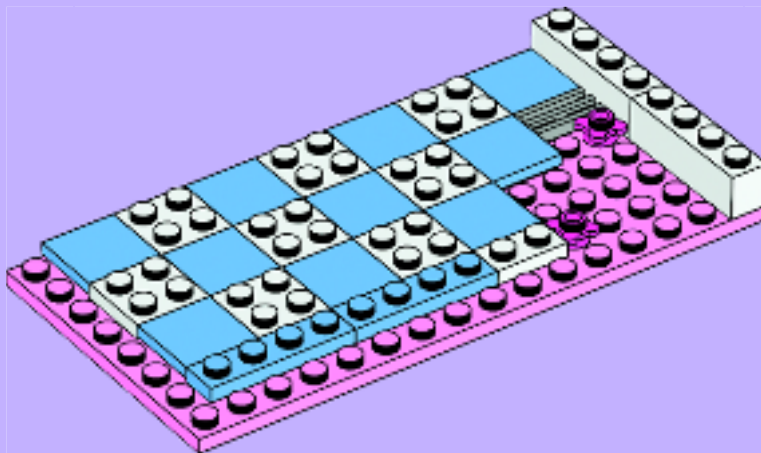

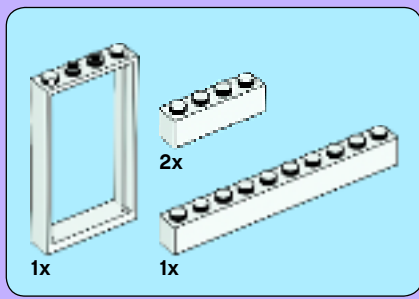

4

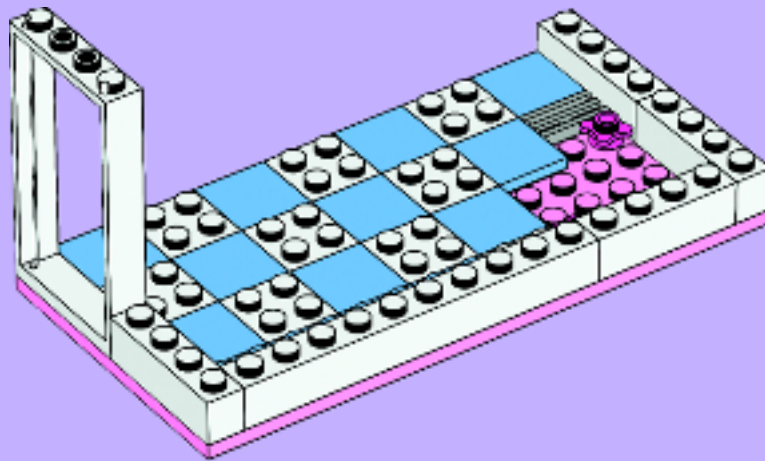

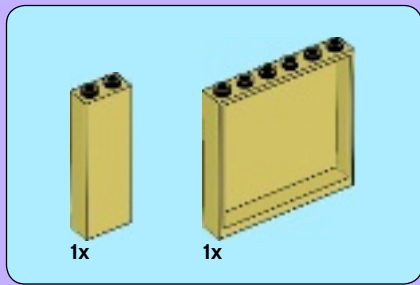

5

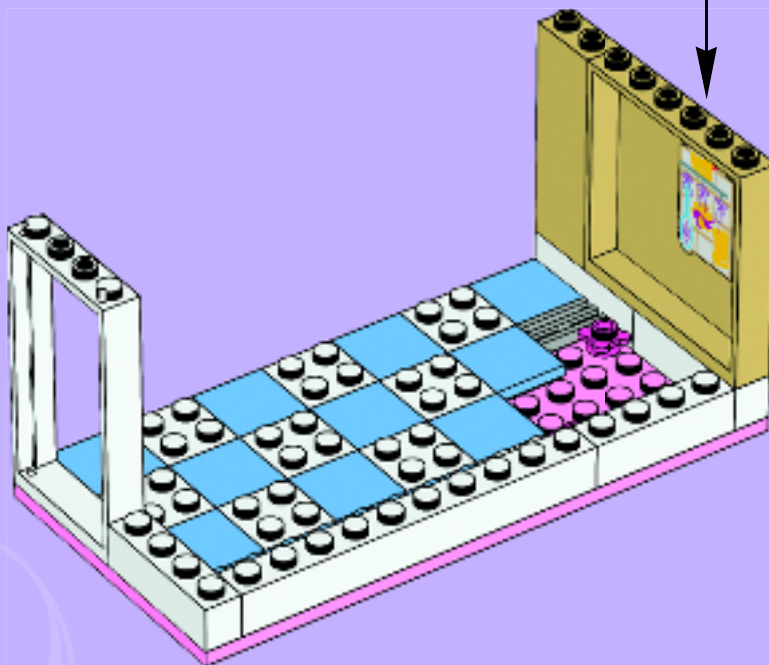
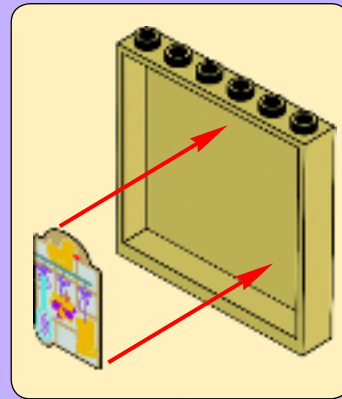

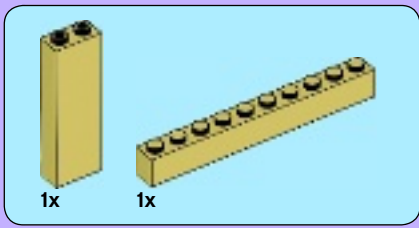

6

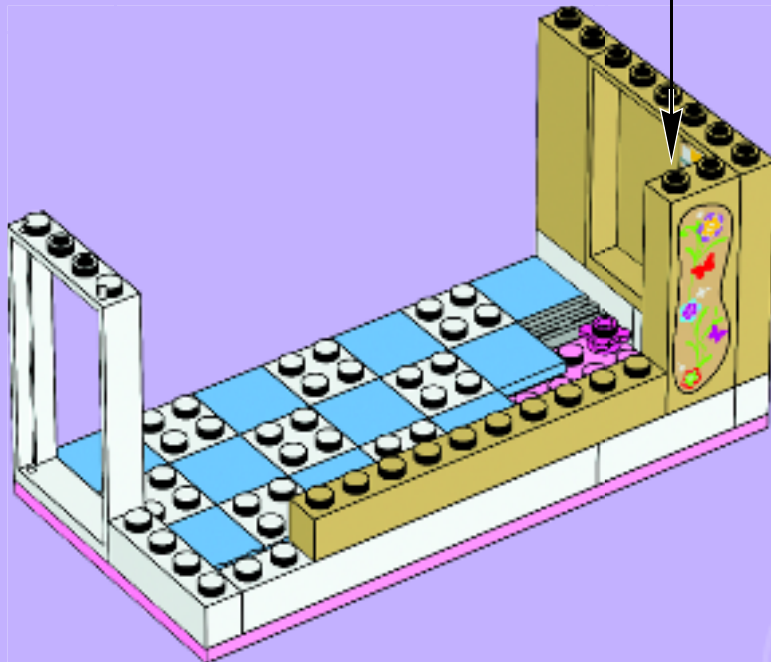
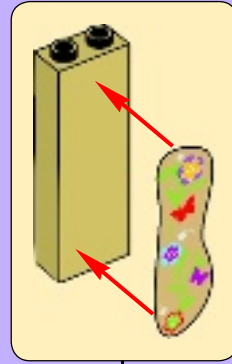

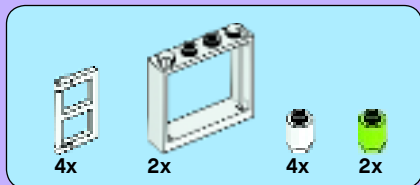

7

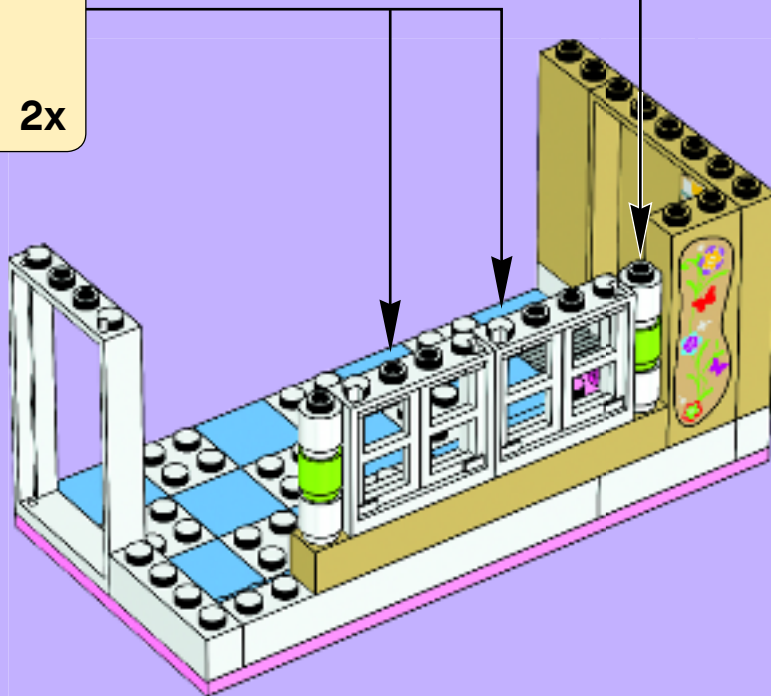
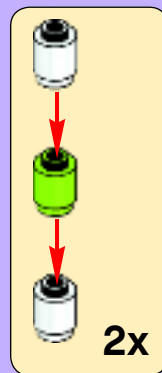
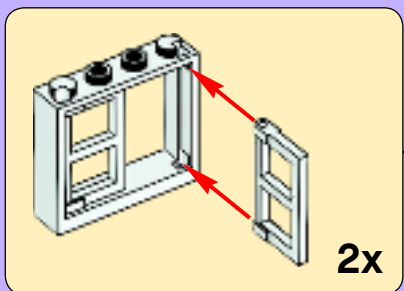

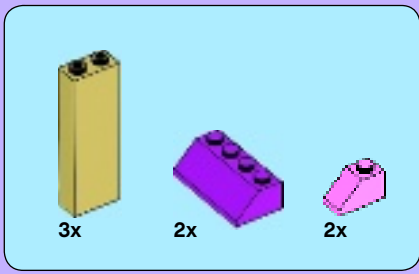

8

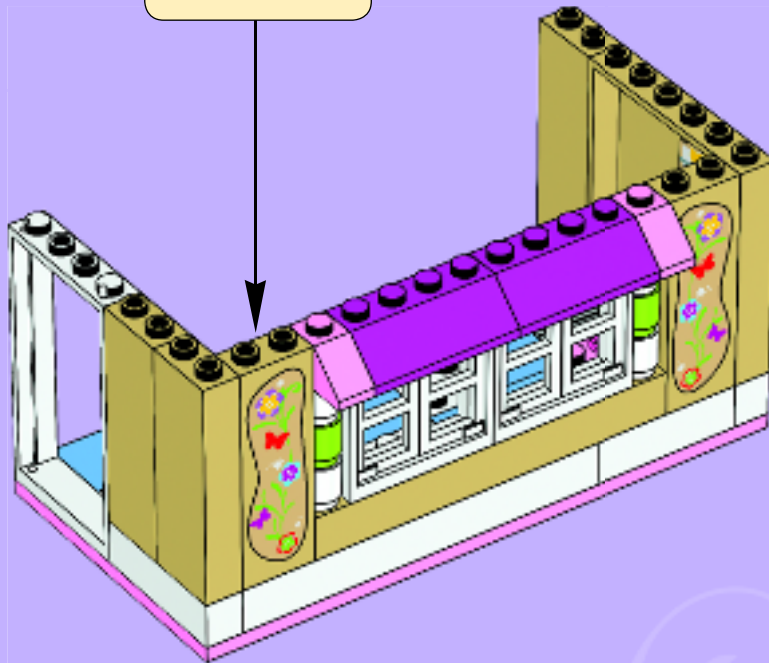
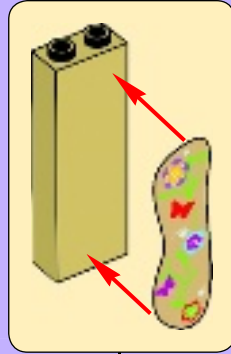

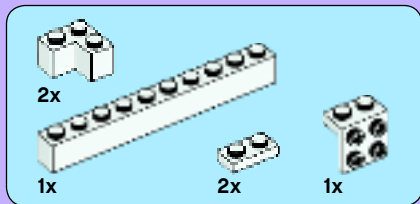

9

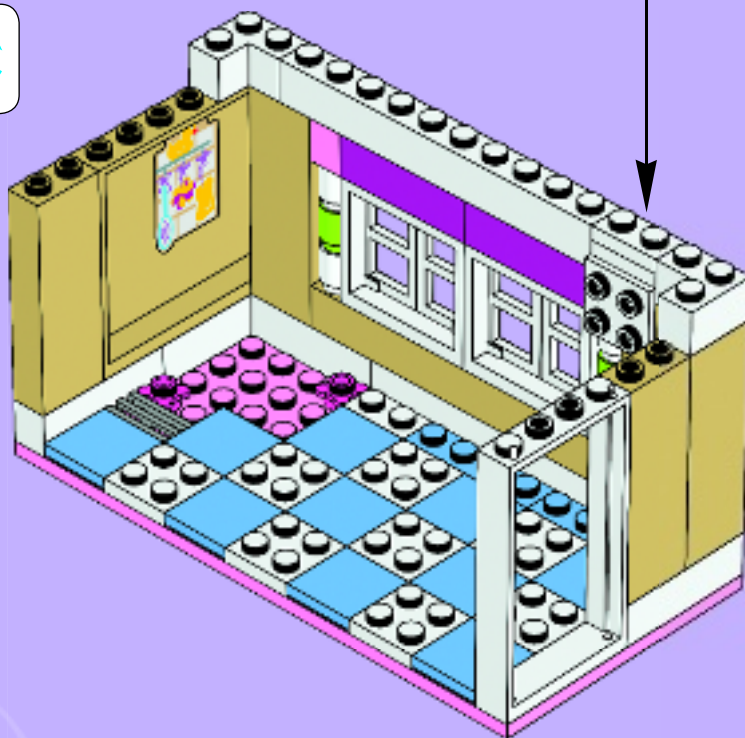
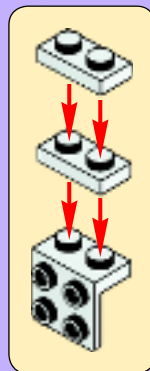
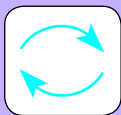

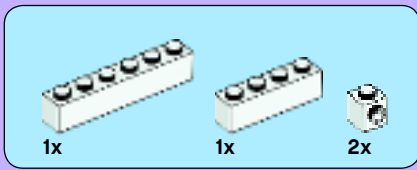

10



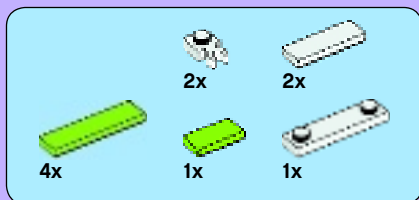

11





1x



1x

12

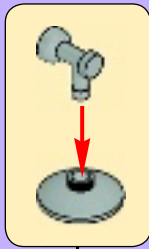

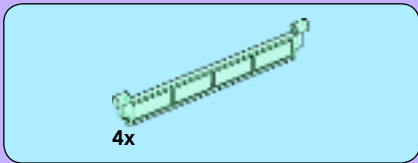

13

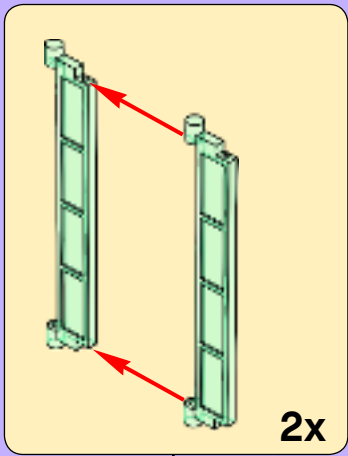

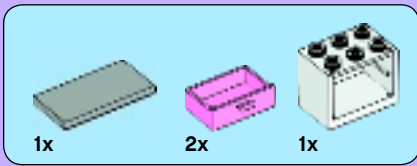

14

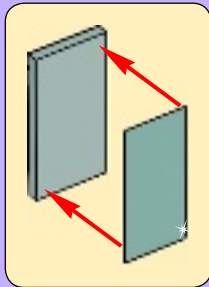
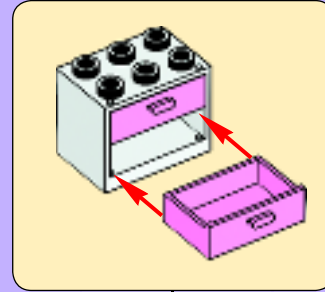



15

1



2

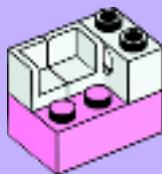

3





16

1

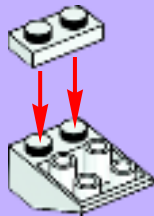

2

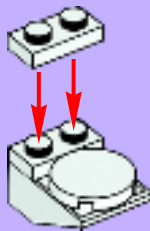

3

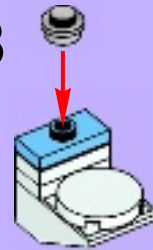



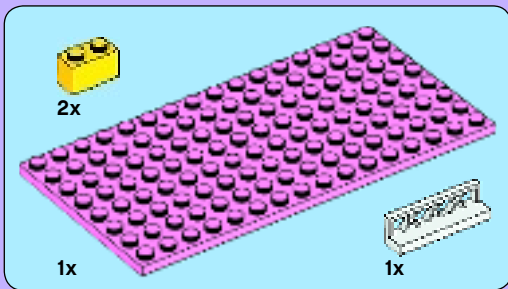
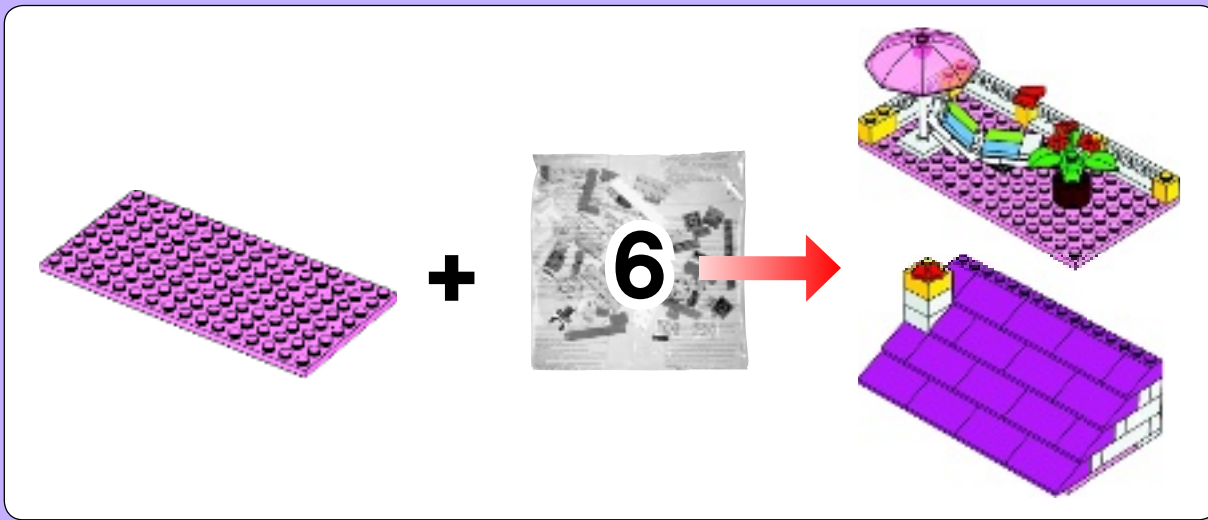

1

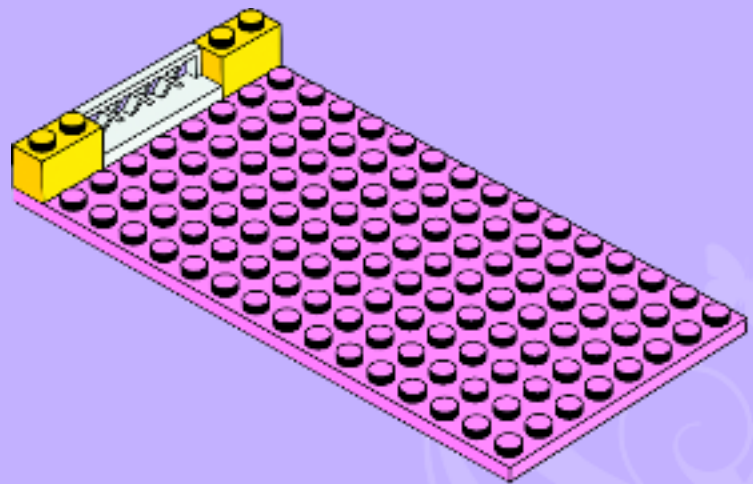

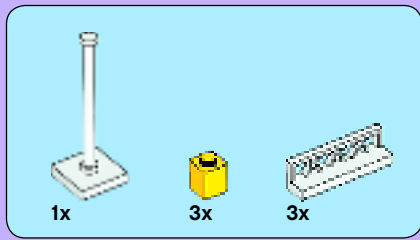

2

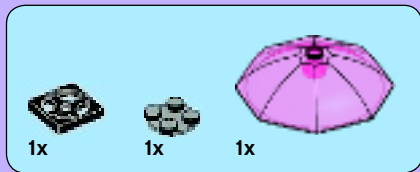
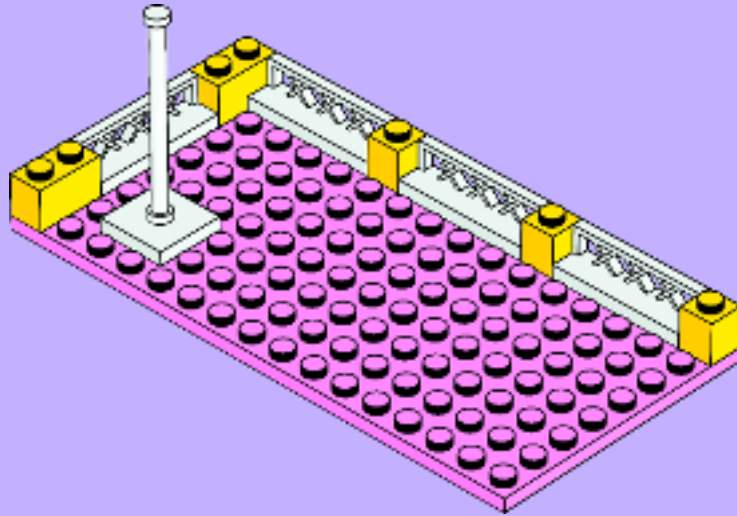

3

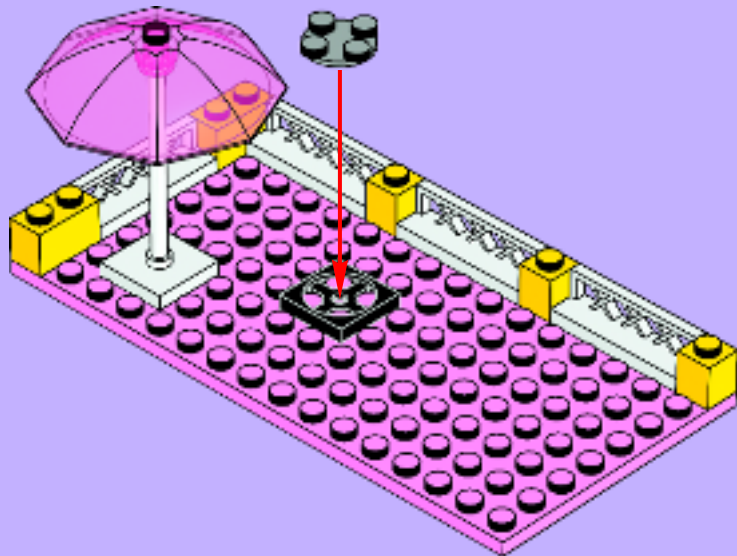

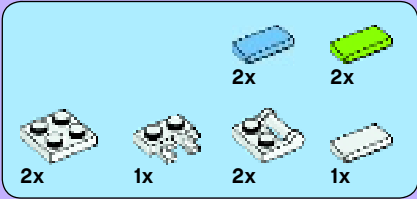

4

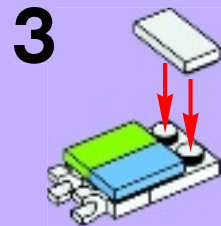
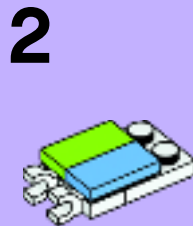
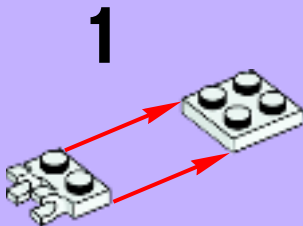

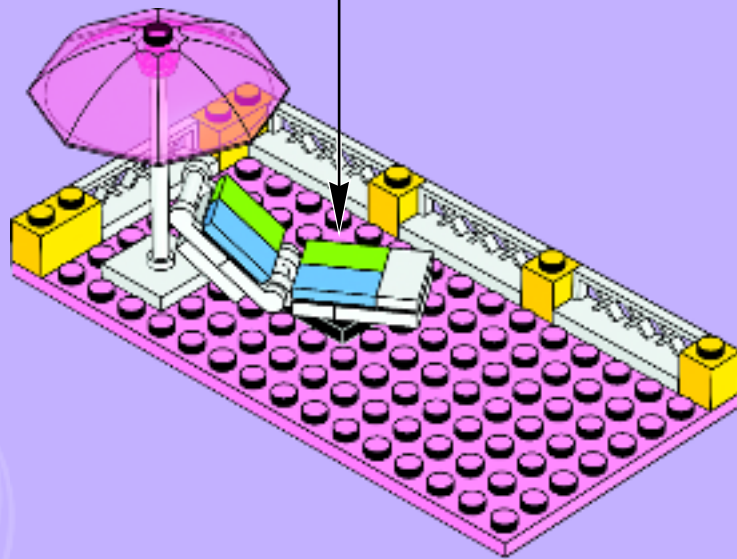
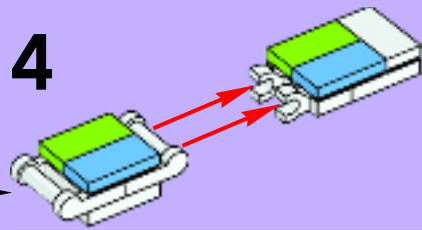



5

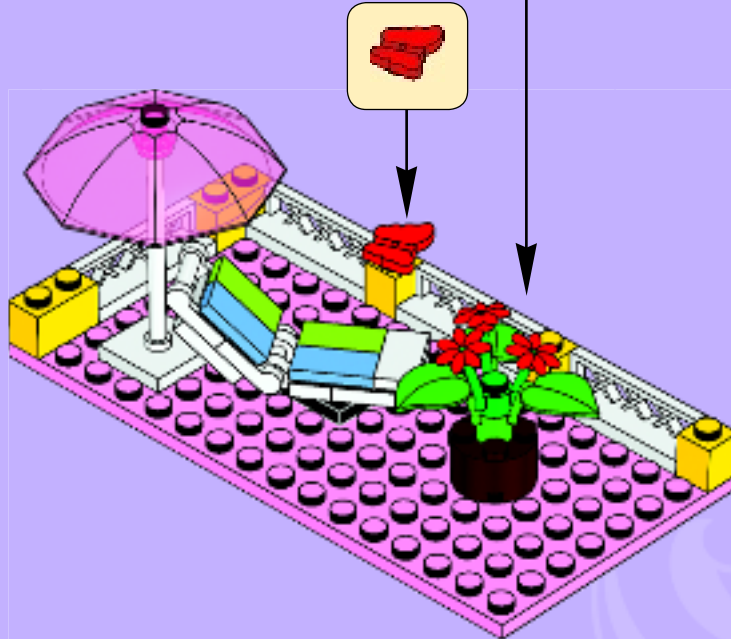
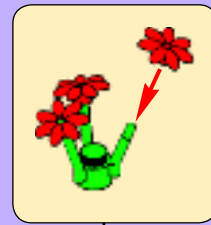
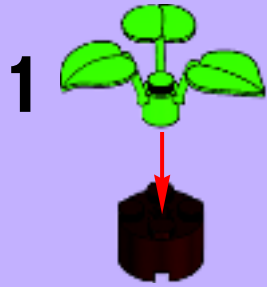



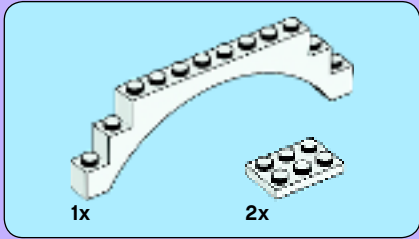
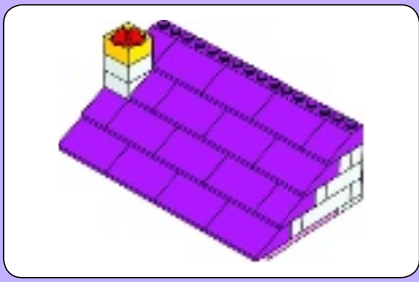

1

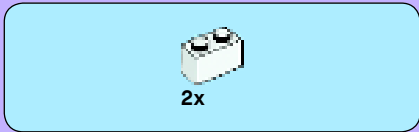
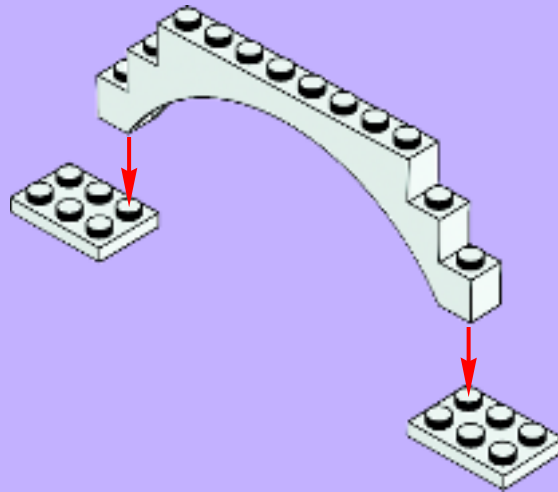

2

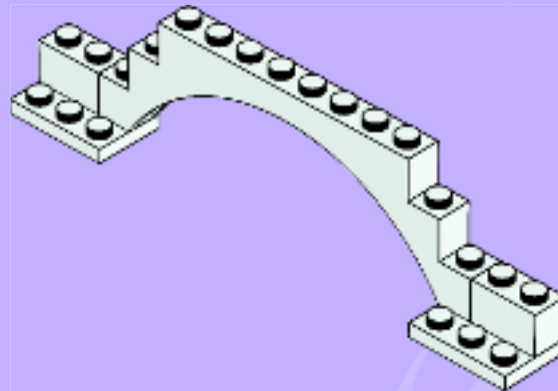



2x

3

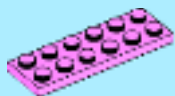
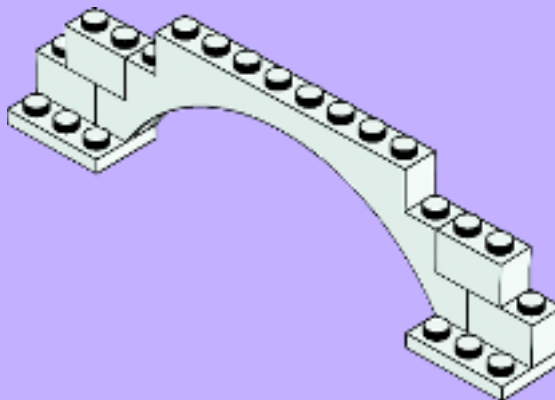

2x

4

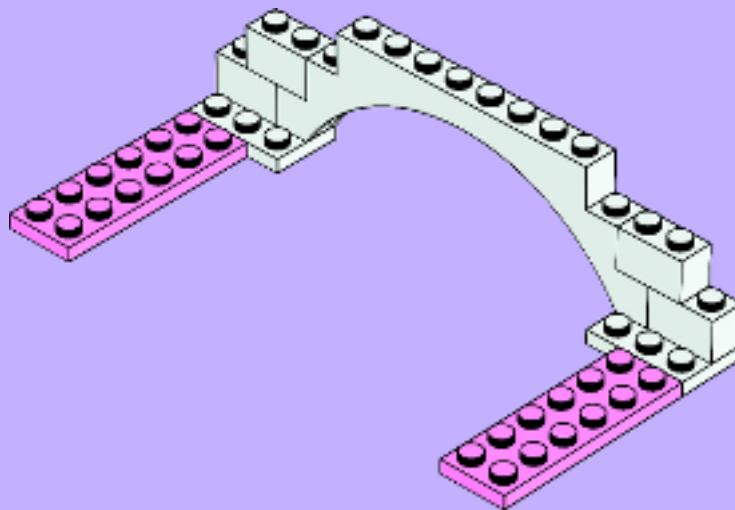



2x

5

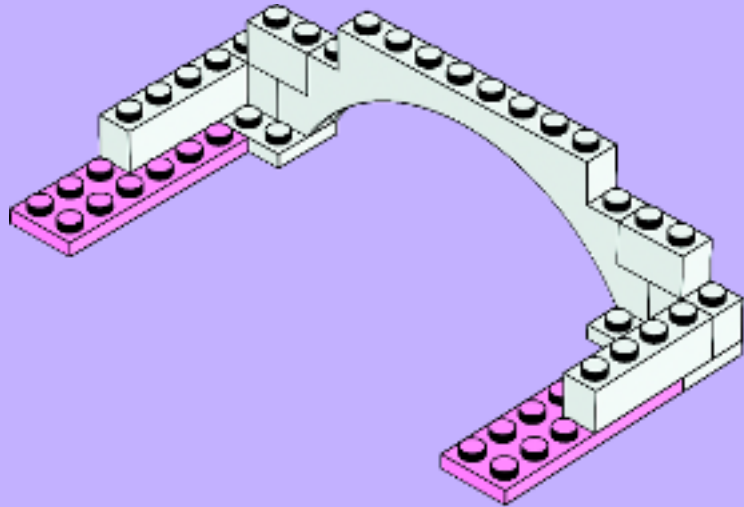

2x



2x

6

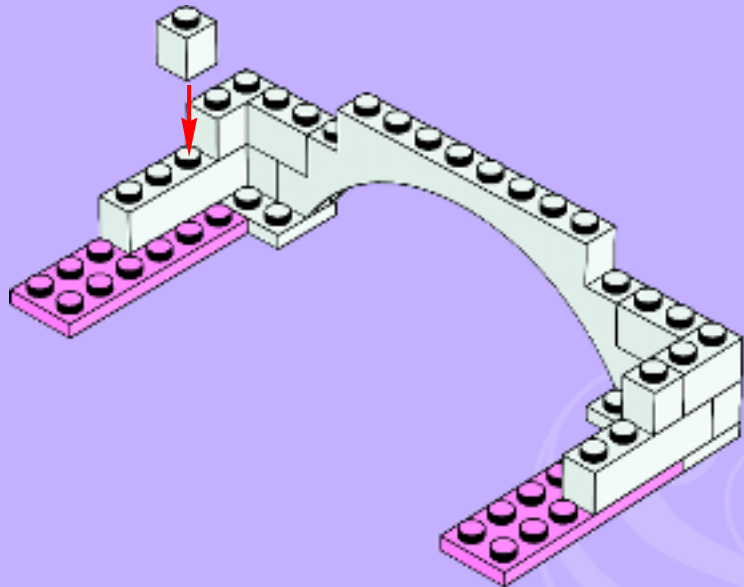



7

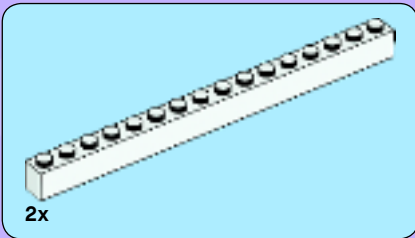
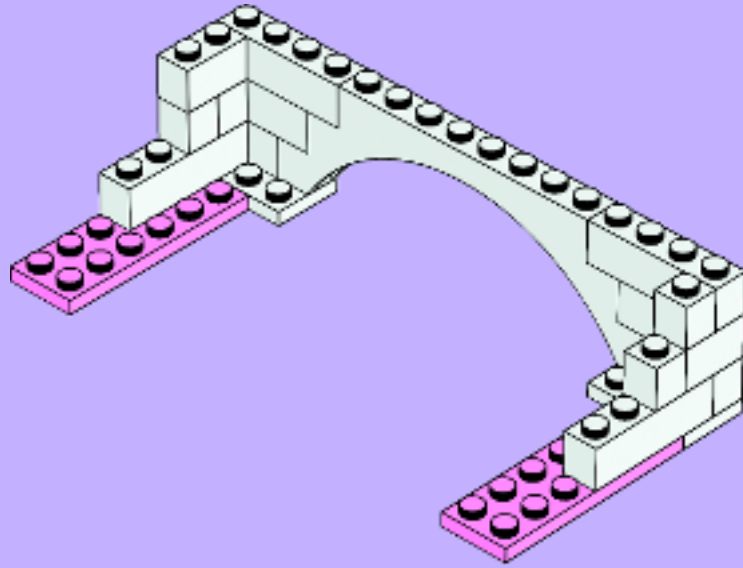

8

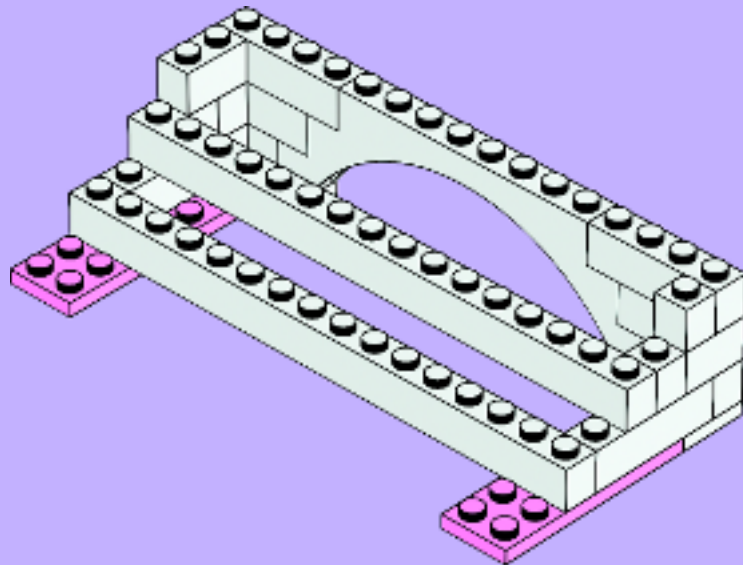

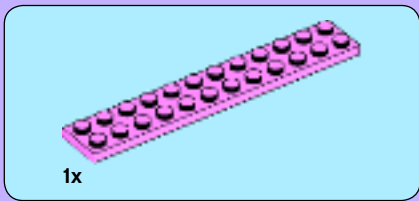

9

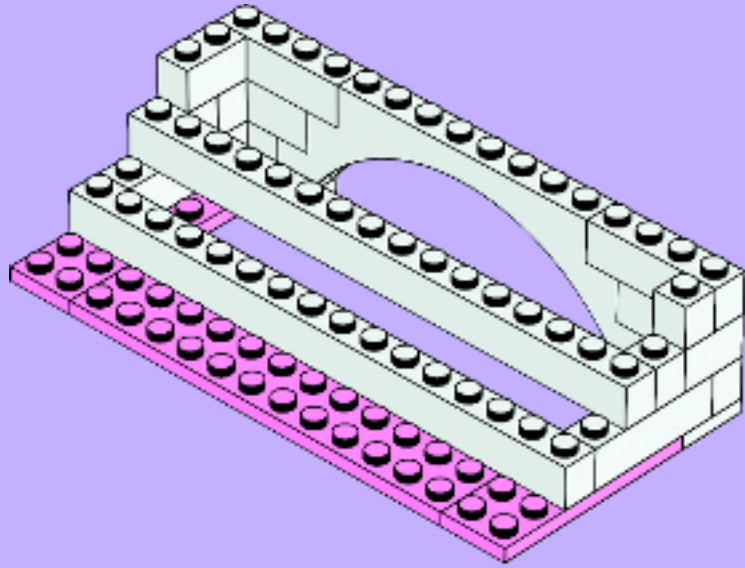

10

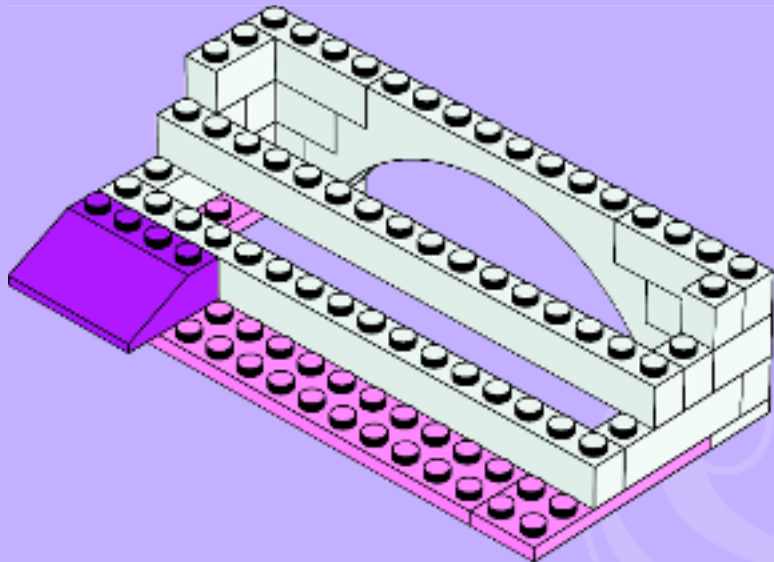



3x

11

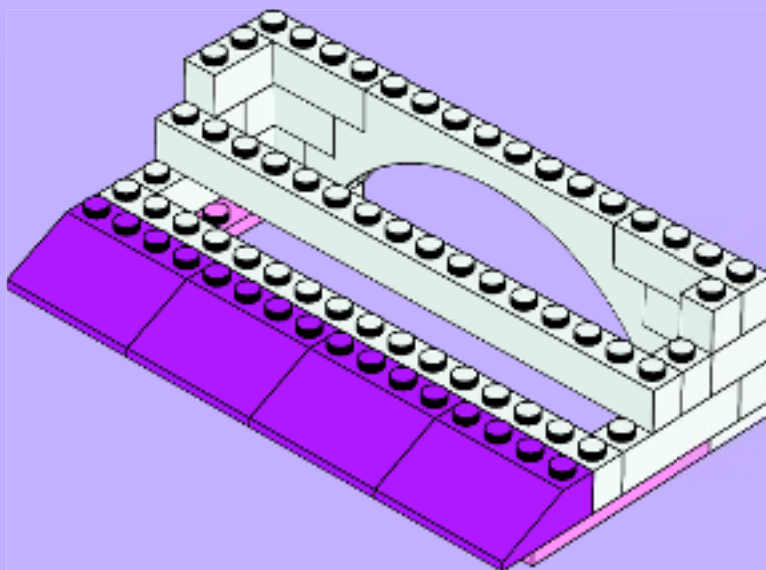

2x



3x

12

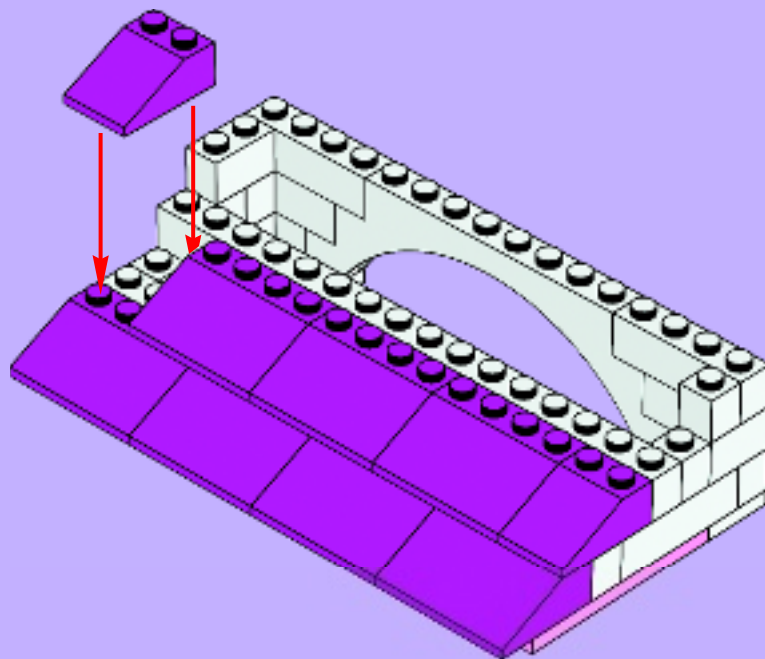

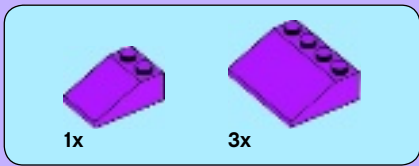

13

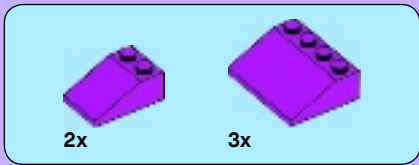
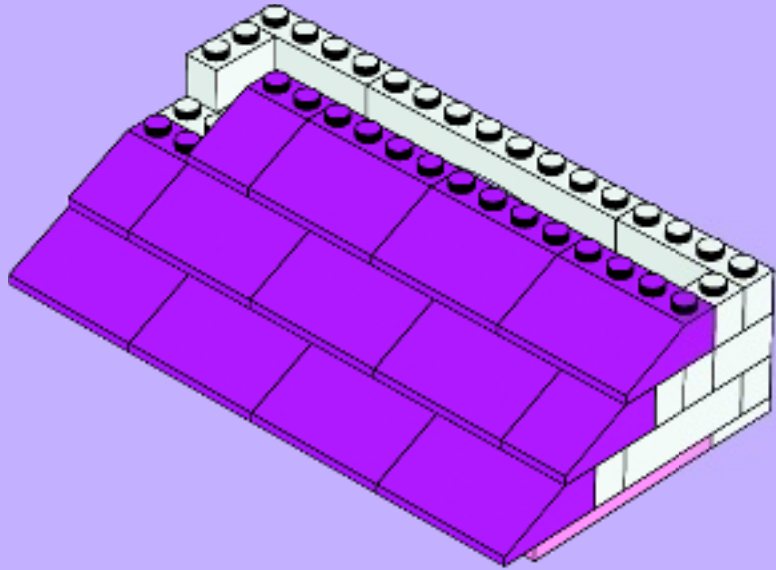

14

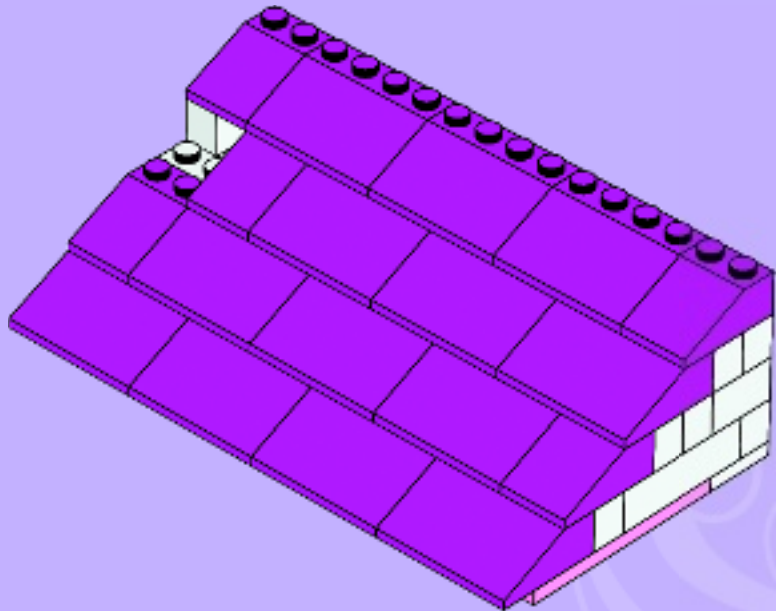



15

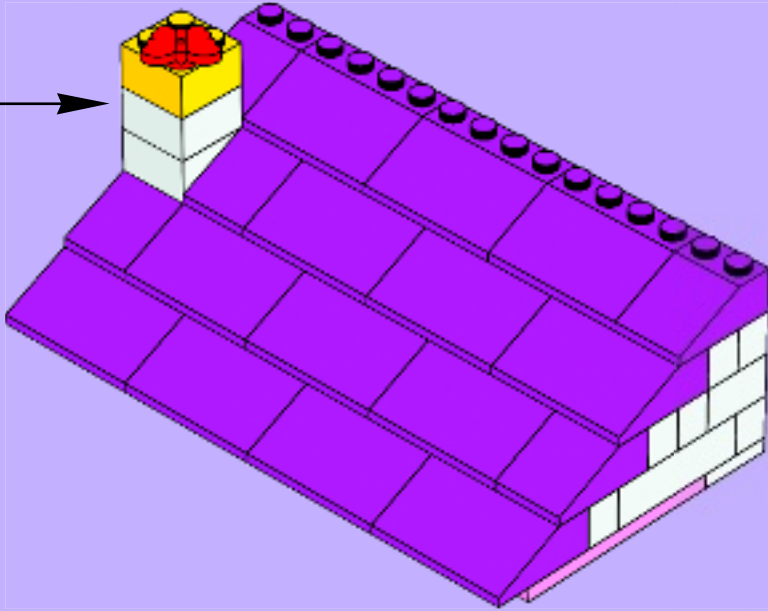
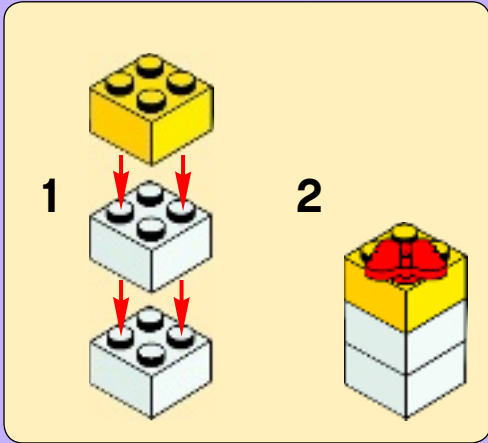



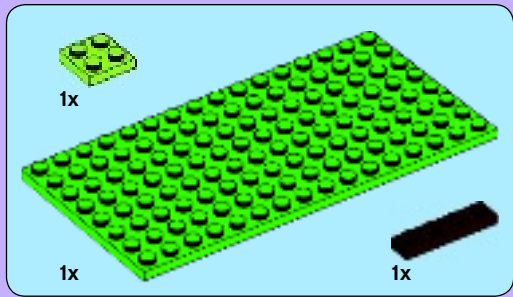
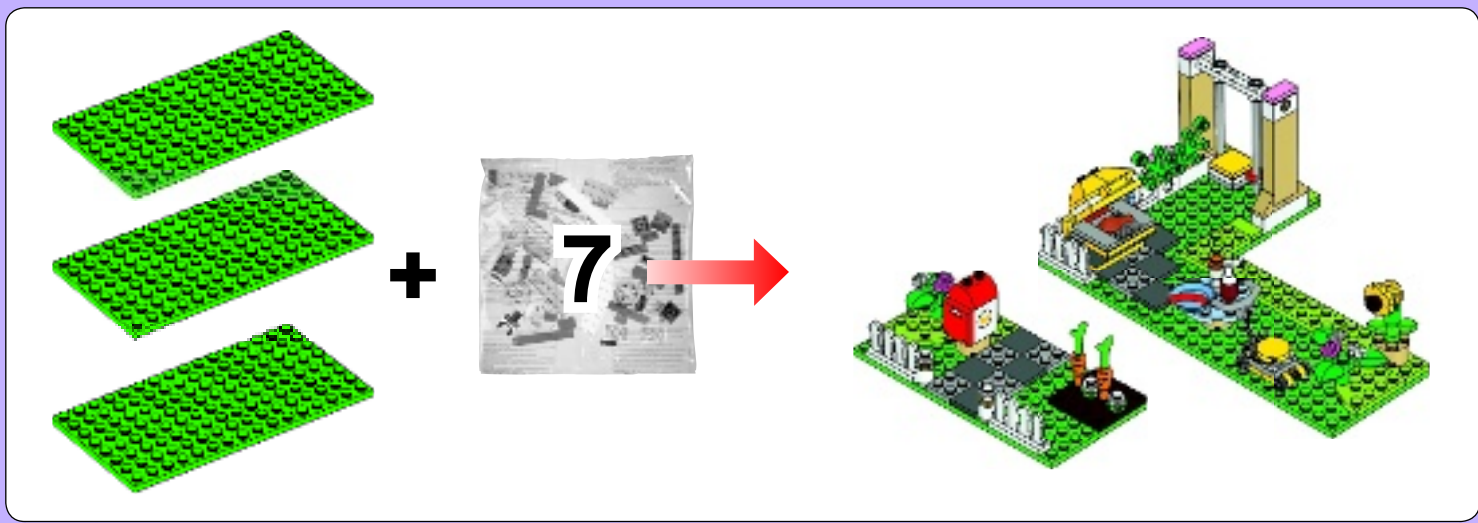

1

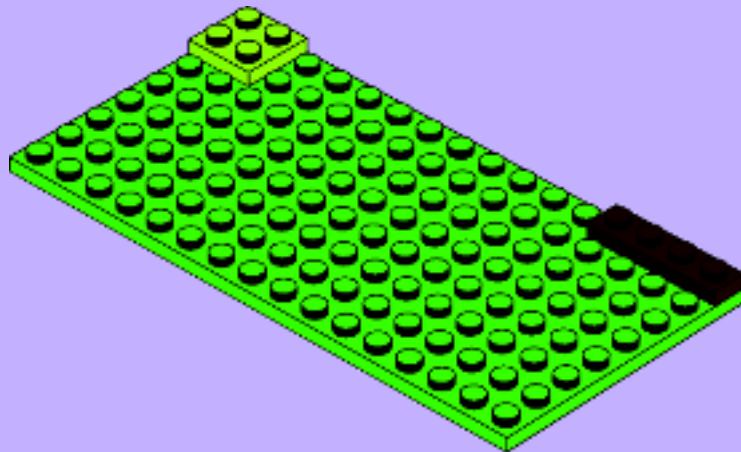



2

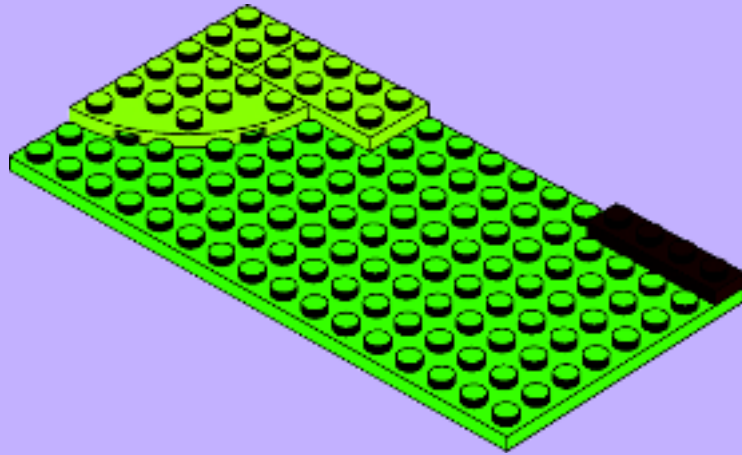

3

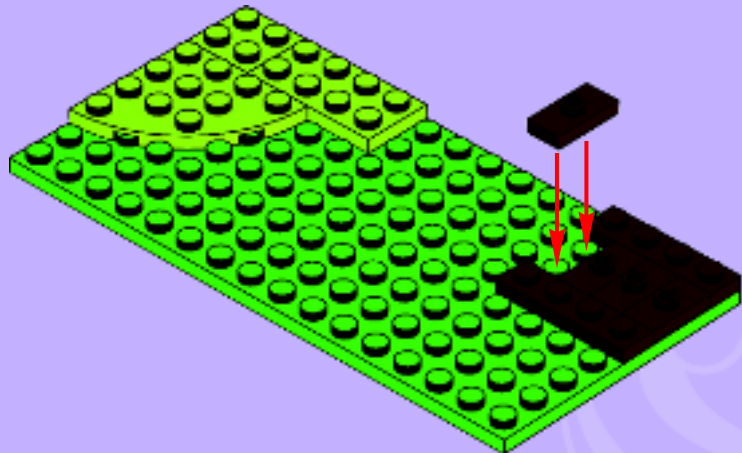



4

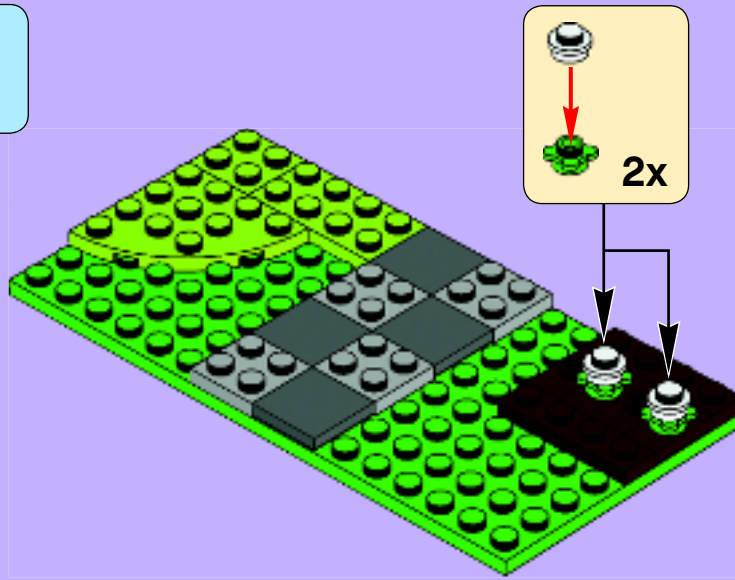

5

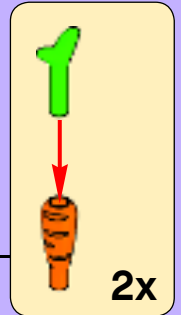
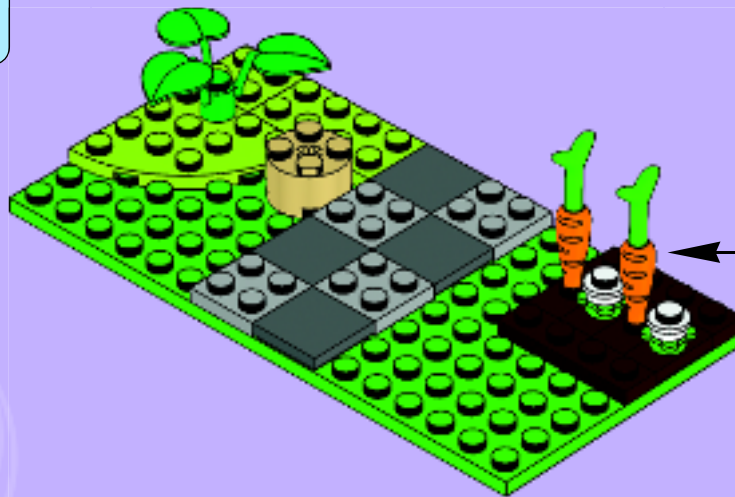

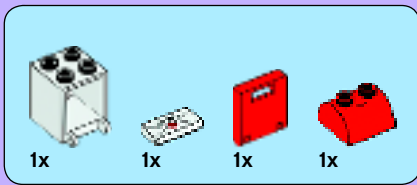

6

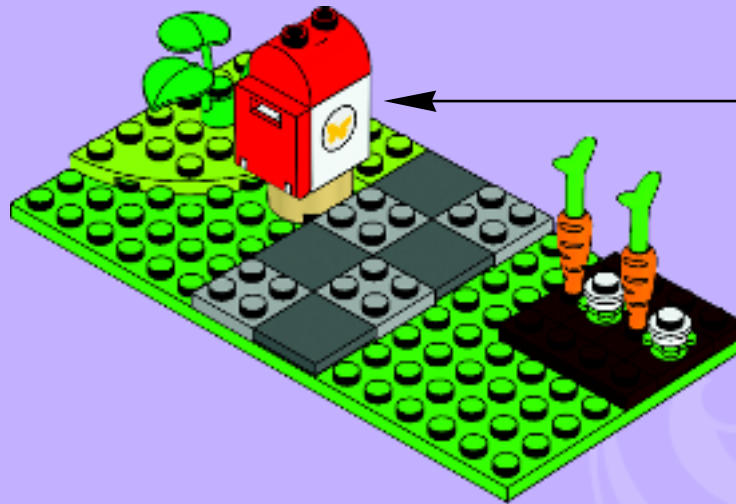
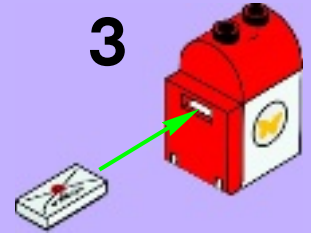
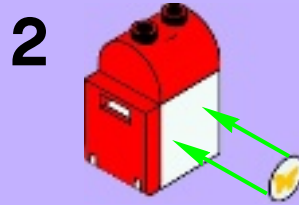
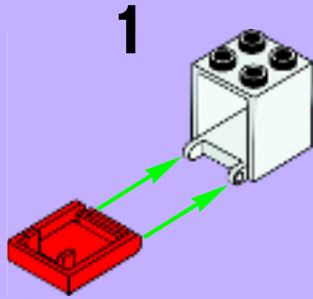



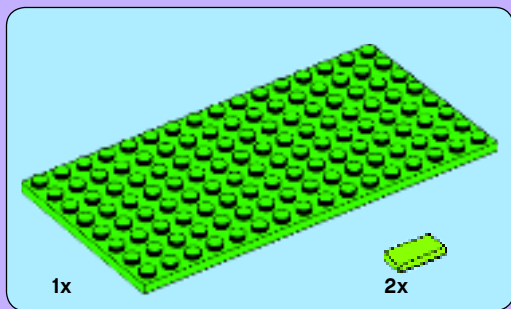
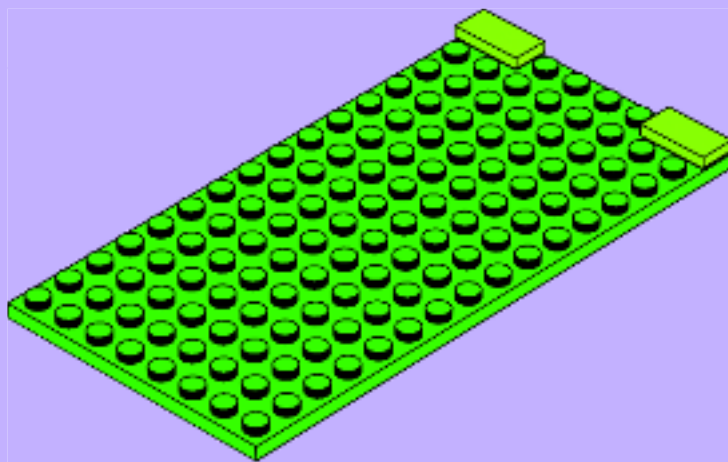

1

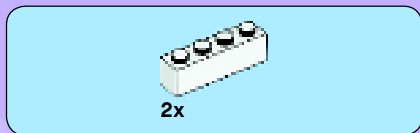
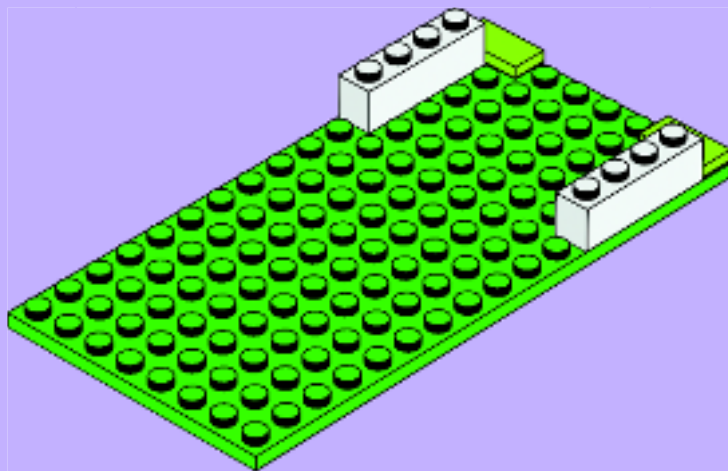

2

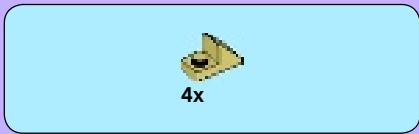

3

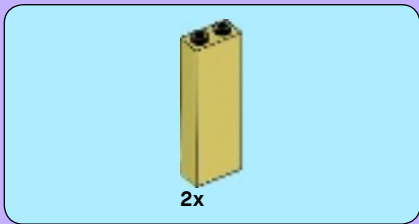
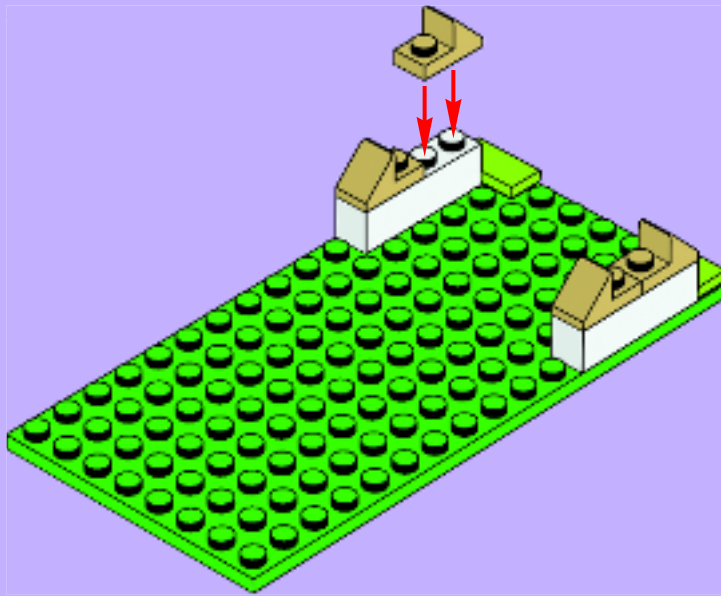

4

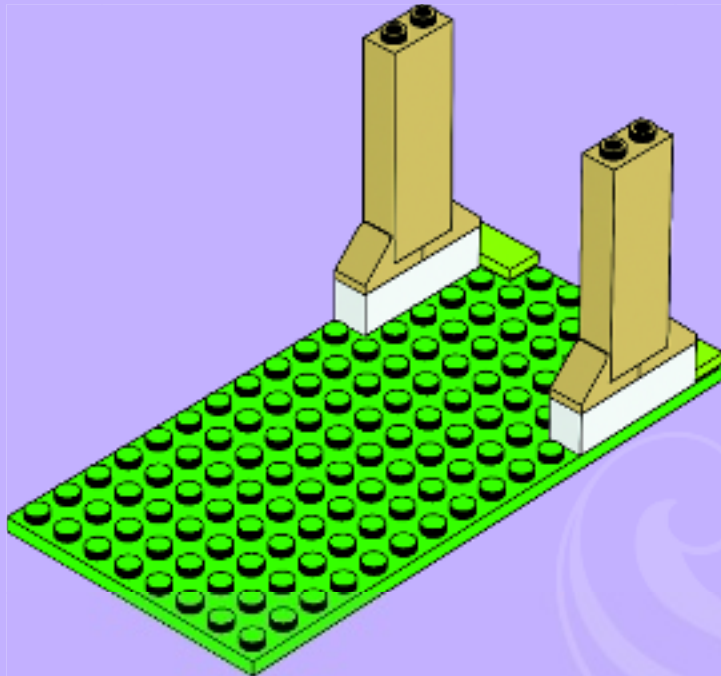

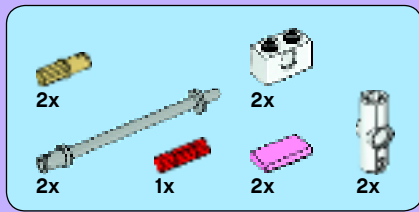

5

1

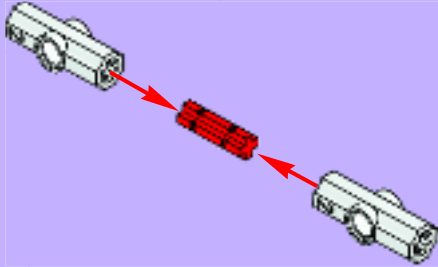

2

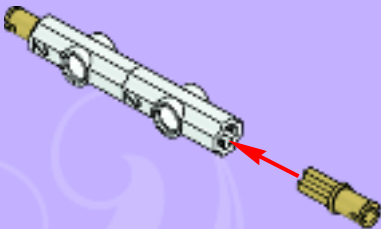

3

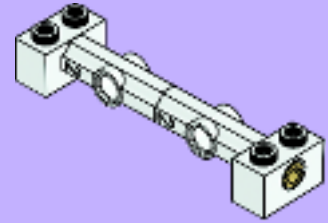

4

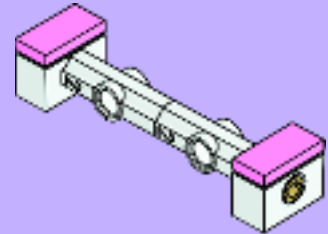

5

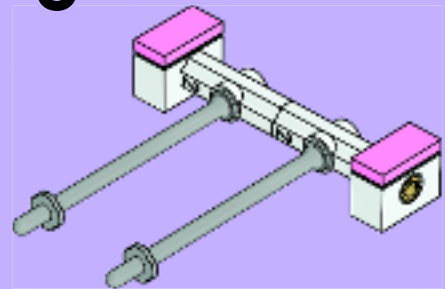

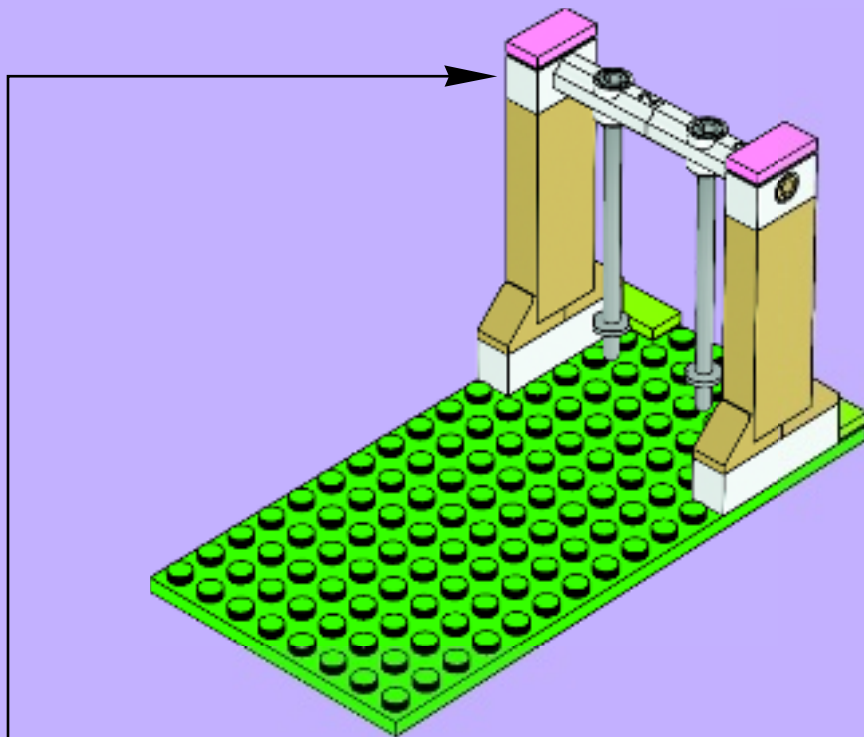



6

1



2



3

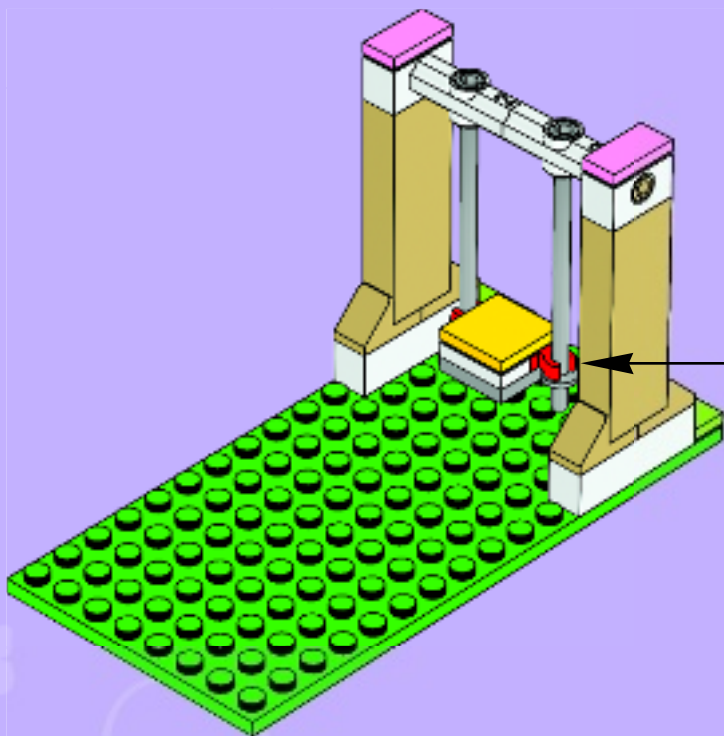



7

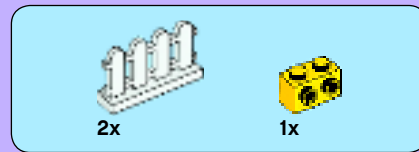
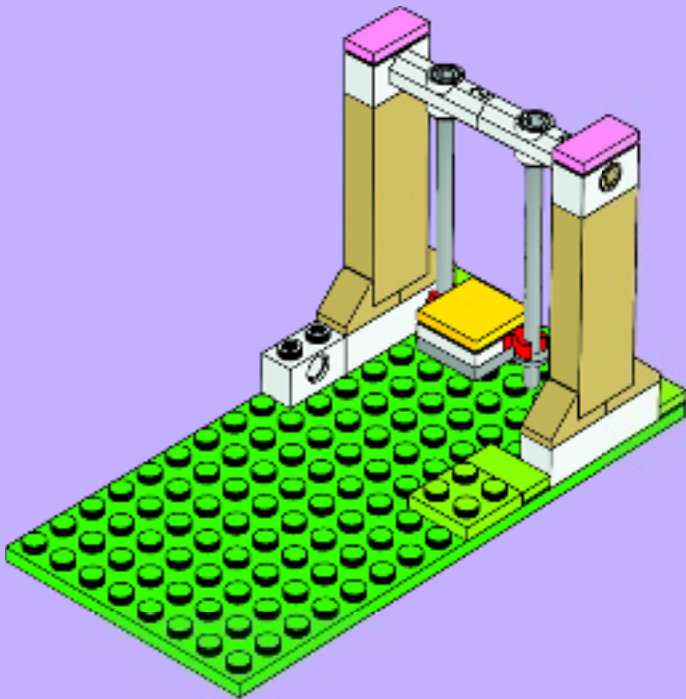

8

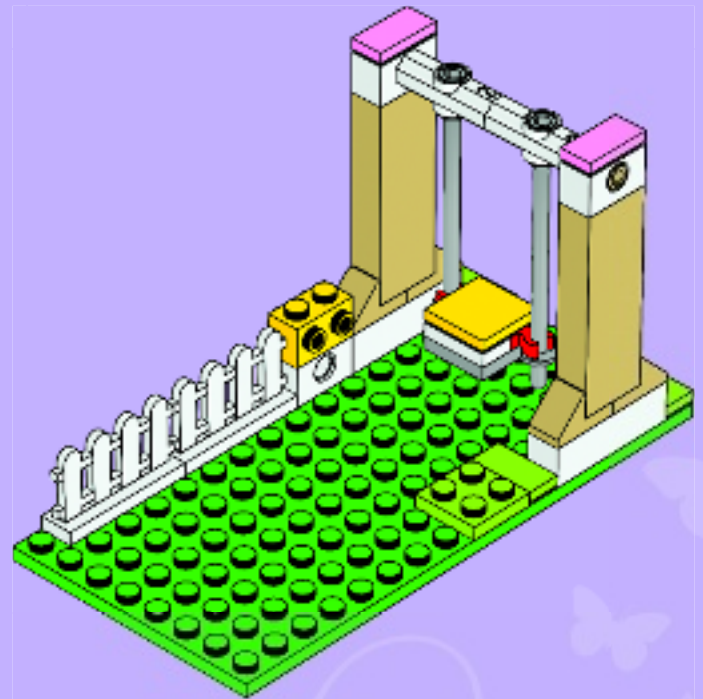



9

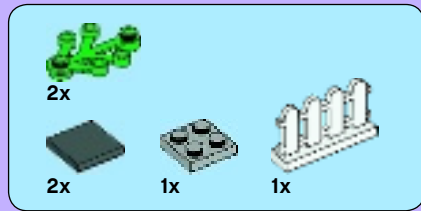
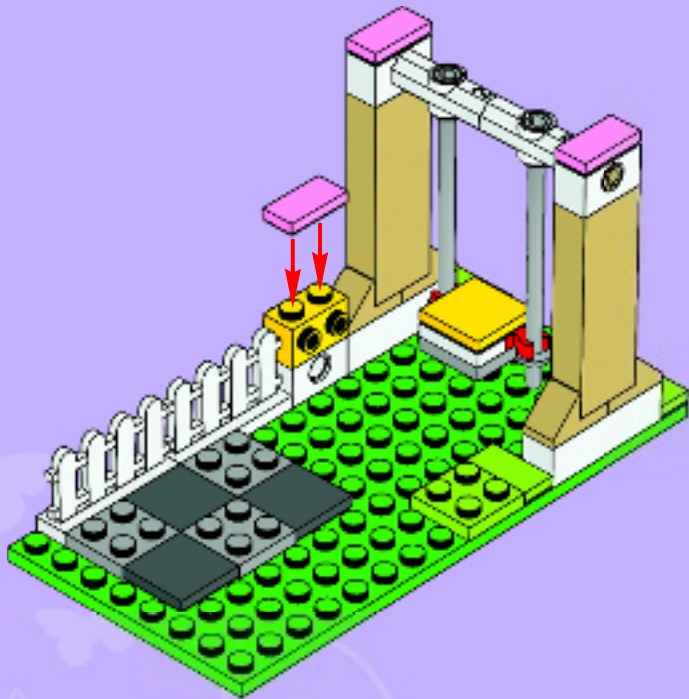

10

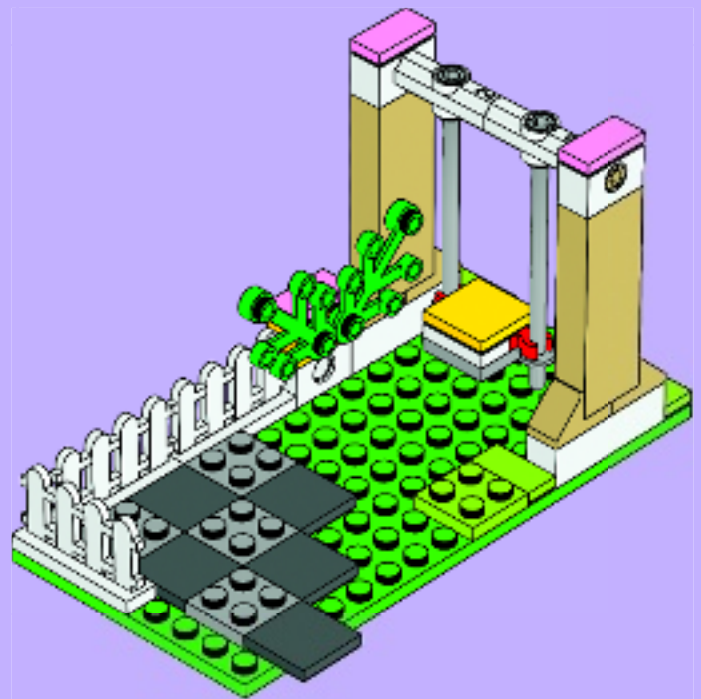

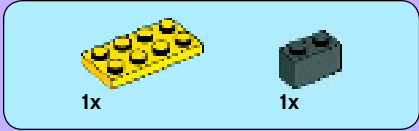

1

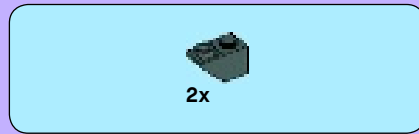
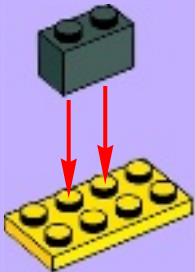

2

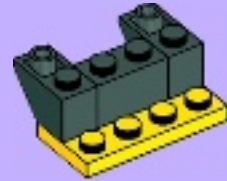

3



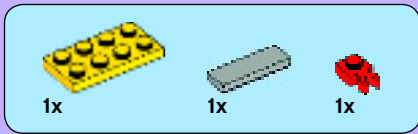

4



5

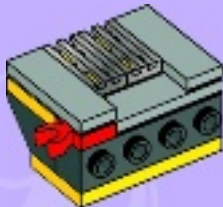

6



7

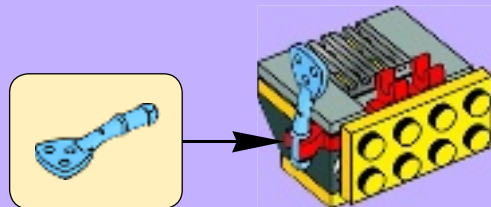



8

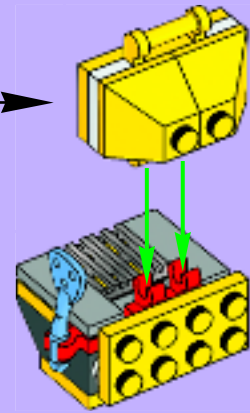

11

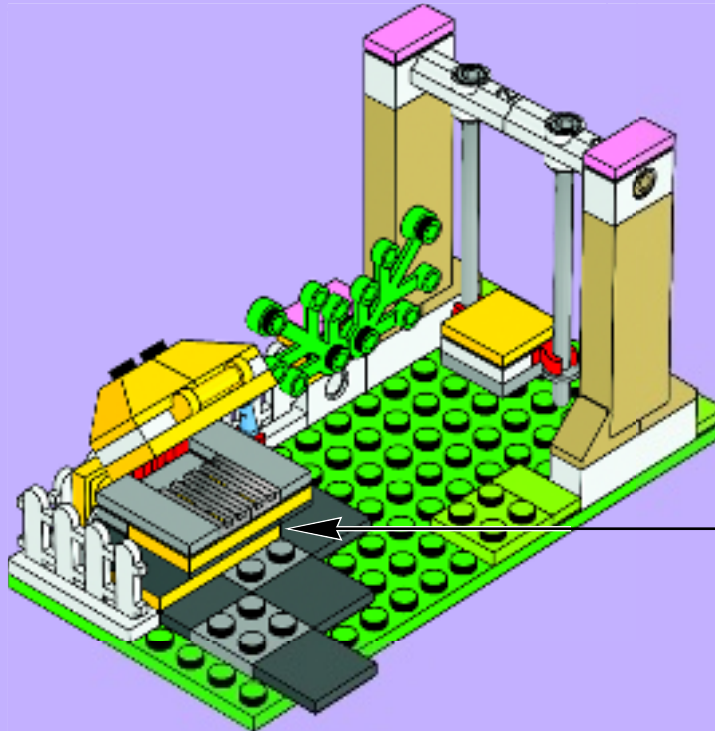

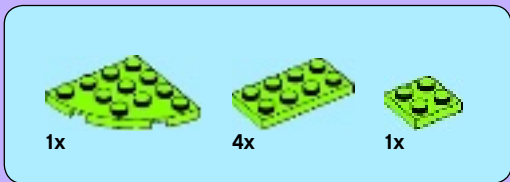

13





1x



1x

14

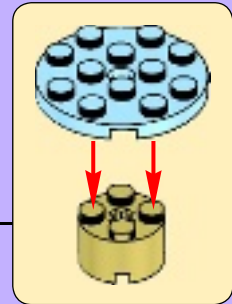

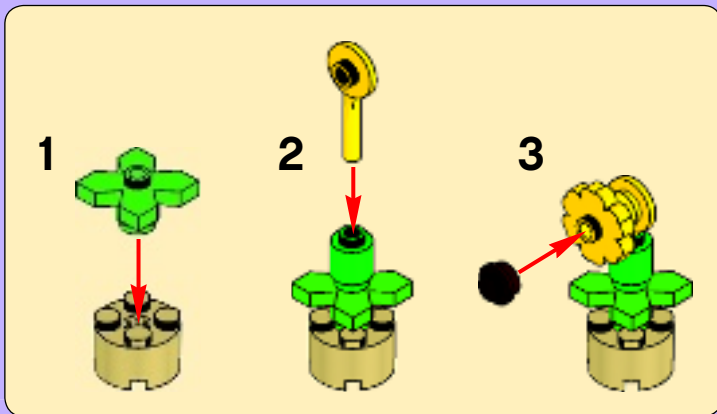

16

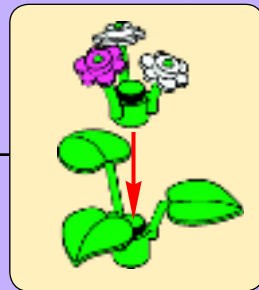



1



2



3



4

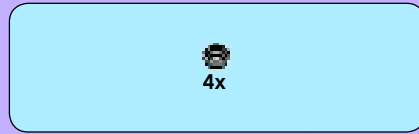
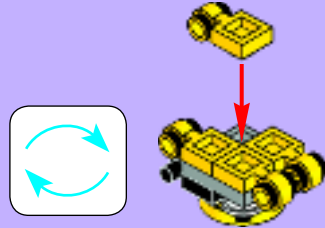

5



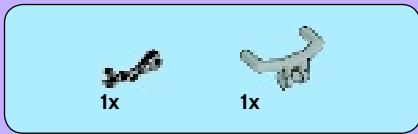

6

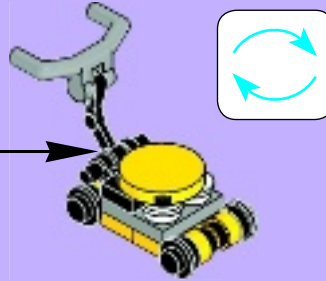
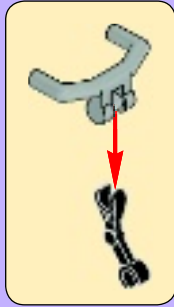

17





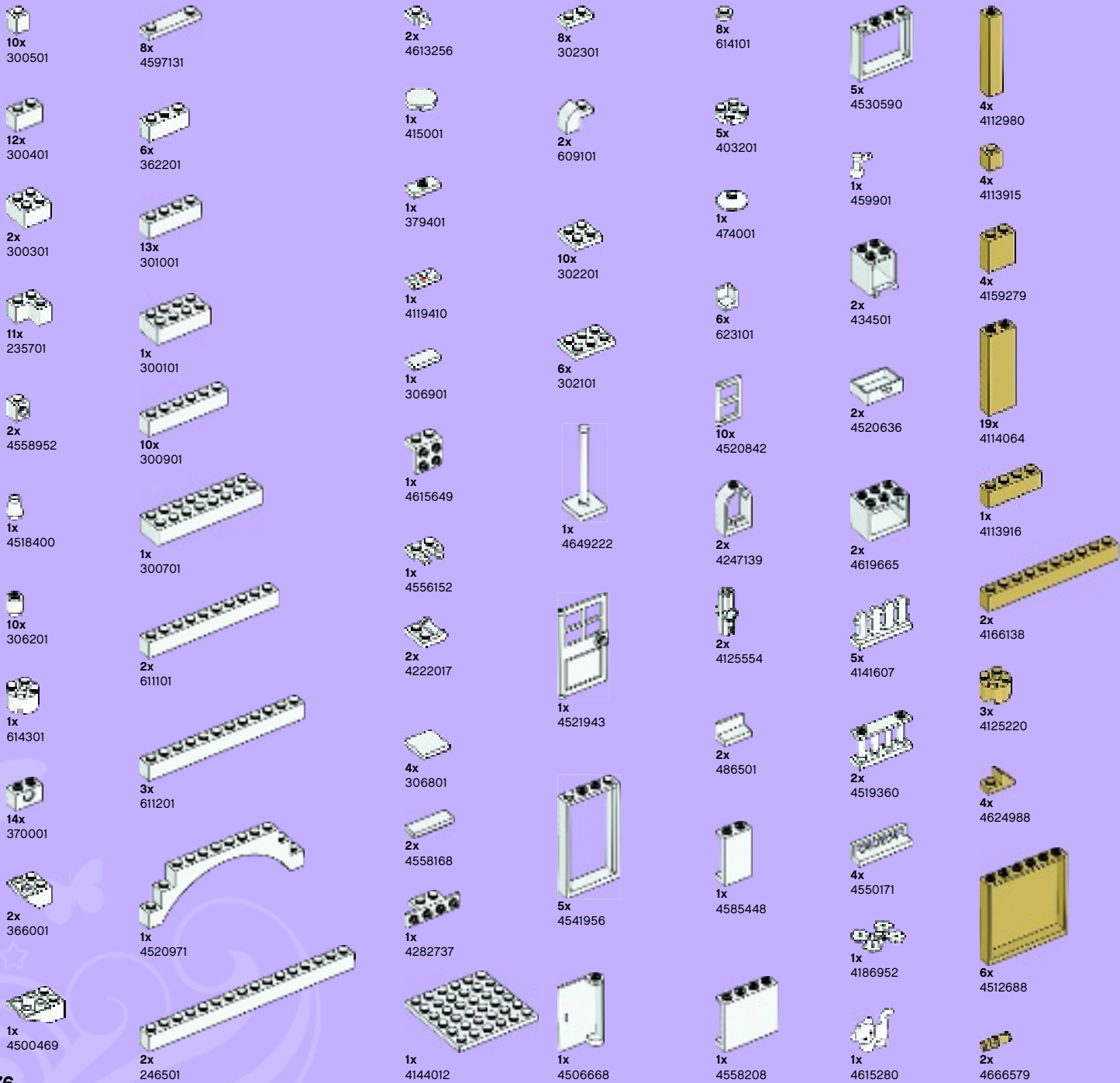



1x
4521852



3x
4588003



2x
4534648



1x
4521851

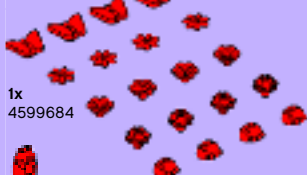

1x
4599684



1x
4622875



1x
4114585



1x
4520952



1x
4142865



3x
300524



2x
300424



2x
300324



3x
614124



1x
472824



1x
4557157



2x
4271076



4x
302024



1x
4243817



1x
379524



4x
4164060



2x
415024



4x
4632569



1x
379424



2x
4501232



1x
306824



1x
244424



2x
243124



1x
4656811



2x
4121715



1x
4529236



1x
654126



1x
4565323

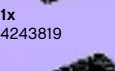

1x
4243819

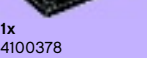

1x
4100378



1x
4140588



1x
4258354



3x
243126



8x
614126



1x
4278359



1x
459926



1x
4596244



1x
4596244



1x
4223247

2x
368026



1x
306228



4x
374128



2x
242328



2x
4106895



5x
4619599



1x
4143562



1x
4107432



1x
4107050



2x
4119479



1x
4278013



1x
4113949



2x
3005740



2x
3005740



21x
4164021



7x
4183133

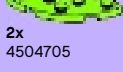

2x
4504705



2x
4625625



1x
4625623



2x
4164022



1x
4220632



3x
4165967



4x
4212454



6x
4537937



12x
4537936



2x
4210212



3x
4541957

10x
4500125



2x
4639698



1x
4219773



1x
3000240



1x
4619596



1x
4565363



2x
4179828



1x
4617013



2x
4168345



10x
4528357



1x
4625280



1x
4625280



1x
4625280



1x
4157103



2x
4119478



1x
4599053



1x
4539099



1x
4243668



4x
4258476



2x
4119482



2x
4567332



7x
3005744



1x
4625280

- 3x 4611415
- 1x 4211166
- 1x 4243784
- 2x 4221744
- 3x 4625626
- 8x 4211190
- 3x 4625626
- 4x 4219726
- 5x 4599547
- 1x 4216581
- 5x 4518889
- 1x 4622483
- 13x 4599548
- 1x 4596241
- 2x 4625630
- 2x 4540203
- 1x 4622176
- 2x 4211386
- 2x 4225532
- 2x 4567340
- 5x 4211383
- 1x 4243797
- 3x 4211412
- 1x 4211350
- 2x 4211414
- 3x 4558169
- 3x 4211356
- 1x 4560183
- 3x 4211525
- 3x 4211475
- 2x 4211512
- 2x 4211503
- 1x 4644102

- 1x 4211445
- 2x 4211859
- 1x 4211407
- 10x 4211397
- 1x 4518892
- 2x 4599538
- 7x 4517995
- 1x 4599830
- 2x 4625633
- 1x 4625631
- 6x 4580010
- 12x 4517996
- 3x 4599534

- 8x 4216479
- 1x 4216375
- 1x 4612369
- 1x 4621334
- 1x 4622871
- 1x 4622827
- 1x 4612370
- 1x 4622873
- 2x 4249040
- 1x 4249039
- 2x 4625629
- 2x 4618658
- 2x 4624705

- 1x 4211088
- 1x 4612374
- 1x 4210725
- 2x 4211096
- 9x 4211055
- 4x 4625616
- 8x 4618659
- 1x 4621993
- 1x 4599545
- 1x 4622046
- 3x 4610355

- 3x 4610353
- 3x 4610353
- 1x 4611414
- 1x 4618526



Customer Service
Kundenservice
Service Consommateurs
Servicio Al Consumidor

www.lego.com/service or dial

00800 5346 5555 :

1-800-422-5346 :



Friends

LEGOFriends.com



Emma



Olivia



Stephanie



Mia



Andrea

Heartlake City



LEGO Friends



3183



3061



3065



3931



3187



3935



3932



3930



3933



3936



3934



3942



3188



3315



CREATOR



5766



5771



5770



LEGO club
FREE! GRATIS! GRATUIT!



www.LEGOclub.com



LEGO® Club Magazine



LEGO® Club Email

VISIT THE WORLD'S
BIGGEST LEGO® SHOP!

www.LEGOshop.com

00800 5346 5555

1-866-534-6258 • 1-877-518-5346

UK Canada

Spain Netherlands



- * Freephone. Mobile charges may apply.
- * Numéro sans frais. Des frais peuvent s'appliquer avec les téléphones cellulaires.
- * Gebührenfrei. Kosten für Anrufe aus Mobilfunknetzen können abweichen.
- * Gratis telefonnummer vanaf vaste lijn.
- * Det er et gratis nummer, når du ringer fra fasttelefon.
- * Det är gratis, när du ringer från en fast telefon.
- * Numéro sans frais. Des frais peuvent s'appliquer avec les téléphones portables.

BI115

YES! I want to join the LEGO® Club FREE! **OUI!** Je veux m'abonner au LEGO® Club GRATUITEMENT !

Ja! Ich möchte Mitglied im kostenlosen LEGO® Club werden. **Ja!** Ik wil graag GRATIS lid worden van de LEGO® Club. **Ja!** Jeg ønsker å melde meg inn i LEGO® Club gratis! **Ja!** Jag vill gå med i LEGO® Club GRATIS!

First name • Prénom
Vorname • Voornaam
Fornavn • Förnamn

Last name • Nom de famille
Name • Achternaam
Etternavn • Efternamn

Date of Birth • Date de naissance
Geburtsdag • Geboortedatum
Fødselsdato • Födelsedatum

Street • Adresse
Straße, Hausnr.
Straat, huisnr. • Adress

City • Ville
Ort • Woonplaats
Poststed • Postort

Zip/Postcode
Code Postal • PLZ
Postcode
Postnummer

Email • Courriel
E-Mail • E-post

Boy • Garçon
Junge • Jongen
Gutt • Pojk

Girl • Fille
Mädchen • Meisje
Jente • Flicka

State
Prov. / County

Country
Pays
Land

- Fill in your email address and we will send you a membership confirmation and monthly email newsletters. If you do not wish to receive the newsletters please tick here. Remplis ton adresse e-mail et nous t'enverrons une confirmation d'adhésion ainsi que le bulletin e-mail mensuel. Si tu ne désires pas recevoir le bulletin, coche cette case. Vul je e-mailadres in en we sturen je een bevestiging van je lidmaatschap en maandelijke e-mail nieuwsbrieven. Als je geen e-mail wilt ontvangen, kruis dan dit vakje aan.
- Ich möchte per E-Mail den monatlichen LEGO Club Newsletter erhalten. Ønsker du at vi skal sende en liten hilsen til barnet ditt for å bekrefte medlemskapet, ber vi deg krysse av i feltet, samt oppgi e-postadressen som hilsen skal sendes til. Om du vill att vi ska skicka en bekräftelse på ditt barns medlemskap, ber vi dig sätta ett kryss i rutan och skriva den e-post adress som bekräftelsen ska skickas till.
- If you do not wish to receive additional mailings from the LEGO Club please tick here. Si tu ne désires pas recevoir de courrier supplémentaire du Club LEGO, coche cette case. Als je geen verdere post van de LEGO Club wilt ontvangen, kruis dan dit vakje aan.
- Dersom du ønsker å motta annen informasjon fra LEGO Gruppen, setter du et kryss her.

Mail to: / Poster à:



LEGO® Club
P.O. Box 1157
Enfield, CT USA
06083-1157

Per Post an:



LEGO® Club
Postfach 14 15
D-36243 Niederaula

Send til:



LEGO® Club Norge
Postboks 58
1314 Vøyenenga

Mail to:



LEGO® Club
33 Bath Road
Slough SL1 3UF
United Kingdom

Stuur na naar:



LEGO® Club
Postbus 40250
3504 AB Utrecht

Skickas till:



LEGO® Club Sverige
Ubox 841
202 29 Malmö

Poster à:



LEGO® Club
21 rue de la banque
75 002 PARIS
FRANCE

The English language version of the magazine can only be mailed to addresses in the US, Canada, the UK, and Republic of Ireland. Club membership is valid for two years and includes free copies of the LEGO Club Magazine and e-mail newsletters. In the US and Canada please allow up to 6 weeks for delivery of your first magazine. In the UK and Republic of Ireland please allow six to 14 weeks for delivery of your first magazine. By signing this form you consent the LEGO Club to use your child's data for LEGO mailings. The data will only be used for LEGO mailings and will not be sold, rented or otherwise disclosed to any company outside the LEGO Company except for disclosure to companies acting as our agents to help us provide services requested by the child. This coupon is valid for one free membership per person, group or organization. Photocopied coupons are accepted. La version française du magazine peut être postée uniquement au Canada. L'abonnement est valide pour 2 ans et inclut des exemplaires gratuits du Magazine LEGO. Aux É.U. et au Canada, attendre 6 semaines pour la livraison initiale. En remplissant ce formulaire, vous consentez à ce que LEGO utilise les informations de votre enfant pour des envois de postaux de LEGO. L'information sera utilisée uniquement pour des envois de postaux par LEGO et ne sera en aucun cas, vendue, louée, échangée ou divulguée à d'autres compagnies autres que la compagnie LEGO, à l'exception des compagnies affiliées qui nous procurent des services auxquels l'enfant en a fait la demande. Formulaires photocopiés acceptés. Mit der folgenden Unterschrift erkläre ich, für mein Kind den Beitritt als Mitglied zum kostenlosen LEGO Club, der von der LEGO GmbH, D-85629 Gräfelfing, betrieben wird. Die Mitgliedschaft beinhaltet die Zusendung des LEGO Club Magazins und kann beiderseits jederzeit beendet werden. Mit der Mitgliedschaft im LEGO Club sind keinerlei Verpflichtungen verbunden. Das deutschsprachige LEGO Club Magazin wird nur an Adressen in Deutschland, Österreich und der Schweiz versendet. Eine Anmeldebestätigung kann nur per E-Mail geschickt werden. Das Magazin erscheint fünfmal jährlich. Daher kann die Zustellung des ersten Heftes bis zu drei Monate dauern. Die Mitgliedschaft ist beidseitig jederzeit kündbar, ohne dass Ihnen Kosten entstehen. Sie können der werblichen Nutzung Ihrer Daten jederzeit widersprechen. Kündigung und Widerspruch können Sie telefonisch erklären (00800 / 5346 5555, Anruf gebührenfrei, Kosten für Anrufe aus dem Mobilfunknetz können abweichen) oder an die LEGO GmbH senden. Het Nederlandse LEGO Club Magazine kan alleen worden gestuurd naar adressen in Nederland. Het lidmaatschap is 2 jaar geldig en geeft recht op toezending van het gratis LEGO Club Magazine en LEGO Club e-mails. Het eerste magazine zal binnen 12 tot 14 weken toegestuurd worden. Het lidmaatschap kan op ieder moment opgezegd worden en kan 2 jaar gratis worden verlengd, tenzij LEGO met deze activiteit stopt. Uw gegevens worden uitsluitend gebruikt voor mailings van LEGO en zullen niet worden verkocht, verhuurd of op welke wijze dan ook verstrekt aan derden buiten de LEGO Groep, uitgezonderd de organisaties die namens ons optreden om de informatie te sturen waarvoor toestemming is verleend. Den norske utgaven av magasinet sendes kun til adresser i Norge. Medlemskap i klubben gjelder 12 år og inkluderer gratisutgaver av LEGO Club Magazine. Prøven minimum oppliks seks uker leveringstid for første magasin. Ved å undertegne dette skjemaet, gir du ditt samtykke til at LEGO Club kan bruke opplysningene om barnet ditt i LEGO forsendelser. Dataene vil utelukkende bli brukt i LEGO forsendelser og vil ikke bli solgt, utleid eller på annen måte gjøres tilgjengelig for selskaper utenfor LEGO gruppen, unntatt selskaper som er våre agenter og som hjelper oss å tilby tjenestene barnet etterseer. Dette skjemaet gjelder for ett gratis medlemskap per person, gruppe eller organisasjon. Den svenska versionen av tidningen kan endast skickas till adresser i Sverige. Club-medlemskapet är giltigt i 2 år och innefattar gratis exemplar av LEGO Club Magazine. Vänligen räkna med minimum 6 veckor för leverans av din första tidning. Genom att skicka in det här formuläret godkänner du att LEGO Club använder barnets uppgifter för LEGO utskick. Uppgifterna kommer bara att användas för LEGO utskick och kommer inte att säljas, hyras ut eller vidarebefordras till något företag som inte tillhör LEGO Gruppen, med undantag av företag som agerar som våra ombud för att tillhandahålla tjänster som barnet har begärt. Den här kupongen gäller för ett gratis medlemskap per person, grupp eller organisation. En complétant ce bulletin d'adhésion, vous acceptez que LEGO Club utilise les données relatives à votre enfant pour l'envoi de courriers concernant LEGO. Ces données seront uniquement utilisées pour l'envoi d'information concernant LEGO et ne seront ni vendues, ni louées, ni utilisées par d'autres sociétés que le groupe LEGO, à l'exception des sociétés agissant pour le compte de LEGO en tant que sous-traitant de services divers. L'abonnement au LEGO Club est valable pour deux ans. Il inclut l'envoi par courrier du magazine LEGO Club et par email des newsletters. Un délai de 6 à 14 semaines est à prévoir pour la réception de votre premier magazine. Ce bulletin d'adhésion garantit est valable pour l'inscription d'une seule personne. Les photocopies sont acceptées. ATTENTION! Le bulletin d'adhésion doit être rempli et signé par un parent ou un tuteur.

Parent's signature • Signature d'un parent ou d'un tuteur •
Unterschrift Erziehungsberechtigter • Handtekening ouders •
Foreldres/foresattes underskrift • Föräldras/förmyndares underskrift

Date
Datum
Date



Win!

Go to www.LEGOsurvey.com/product to fill out a survey for a chance to win a cool LEGO® Product.

No purchase necessary.

Open to all residents where not prohibited.

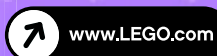

www.LEGOsurvey.com/product

Gewinne! Win!

Nimm an der Umfrage auf www.LEGOsurvey.com/product teil und hab die Chance ein cooles LEGO® Produkt zu gewinnen!

Die Teilnahme am Gewinnspiel führt zu keinerlei Kaufverpflichtungen. Teilnahme in allen nicht ausgeschlossenen Ländern möglich.

Ga naar www.LEGOsurvey.com/product, vul een enquêteformulier in en maak kans op een cool LEGO® product.

Geen aankoopverplichting, iedereen mag deelnemen, uitgezonderd ingezetenden van landen waar een enquêteverbod geldt.

Gagne! 当てよう!

Visite www.LEGOsurvey.com/product pour répondre à un questionnaire et avoir une chance de gagner un produit LEGO® très cool!

Aucune obligation d'achat. Ouvert à tous les résidents des pays autorisés.

www.LEGOsurvey.com/product にアクセスして、アンケートにご記入ください。当選者にはレゴ製品を差し上げます。

お買い上げの必要はありません。

禁止されていない限り、すべての皆様にご利用いただけます。