



HERO FACTORY



2235

FIRE LORD

2067



2063





1

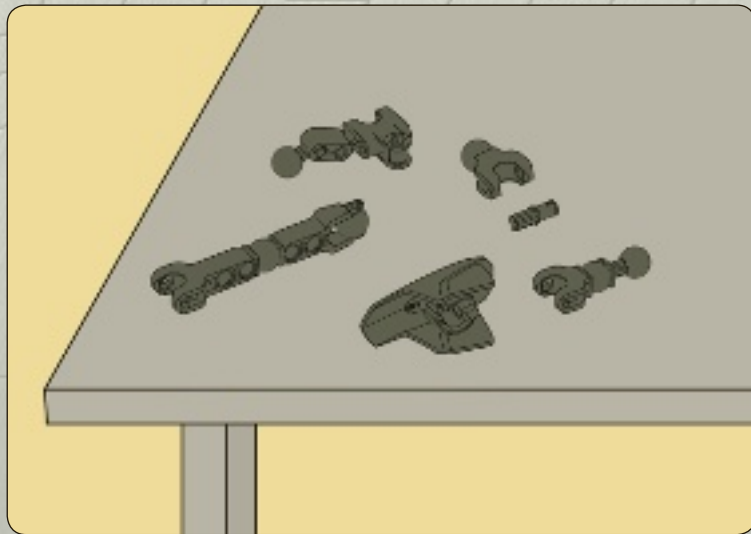
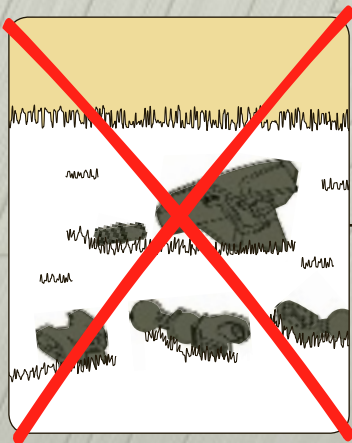

2



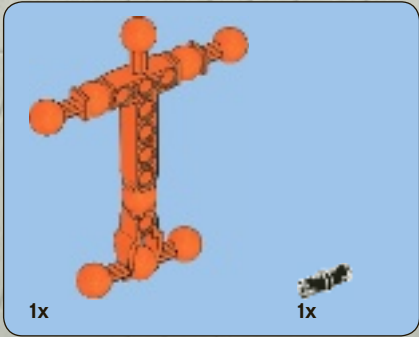
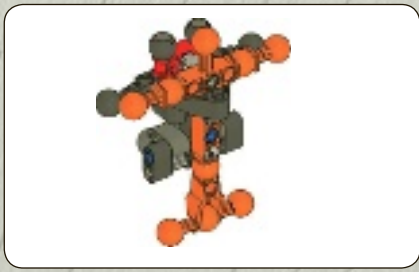

1

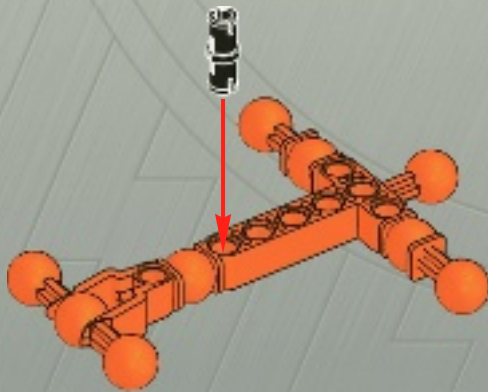

2

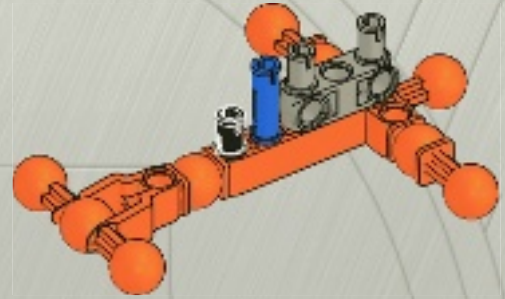

3

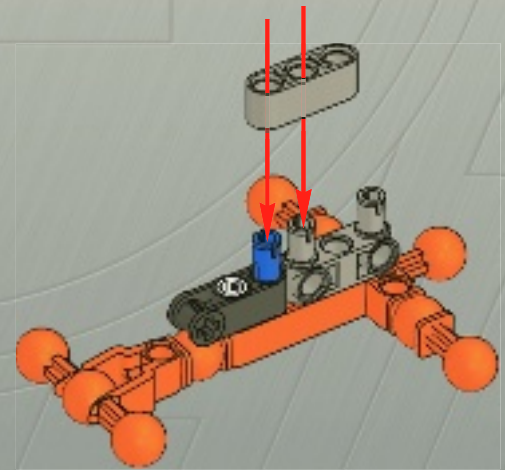

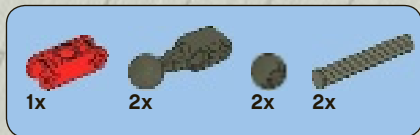

4

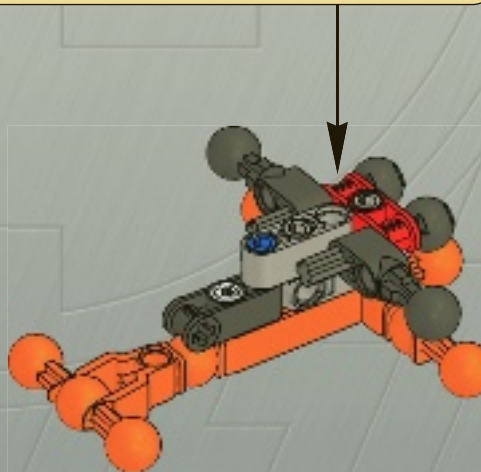
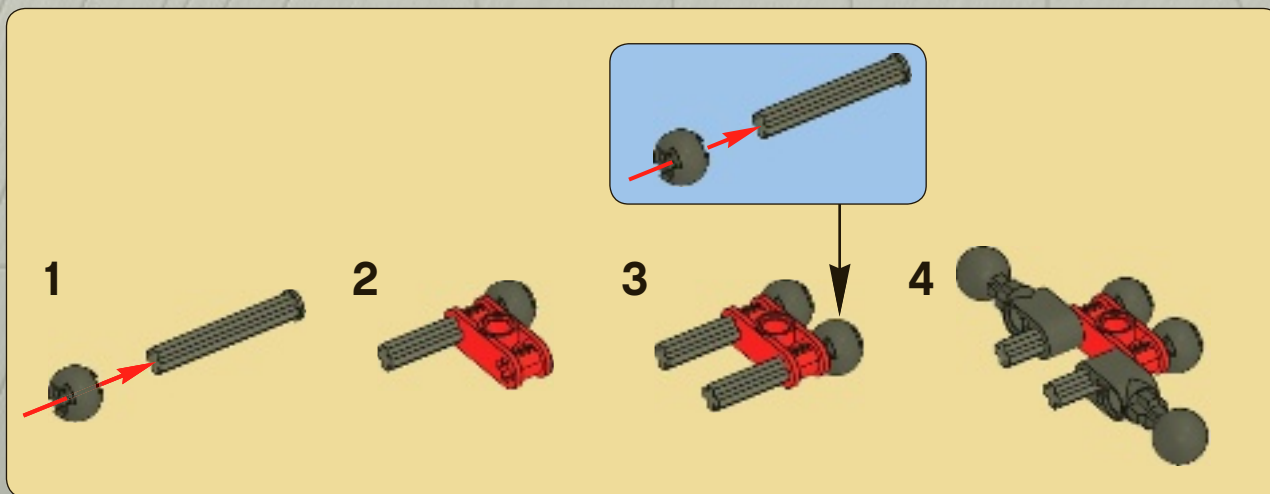



5

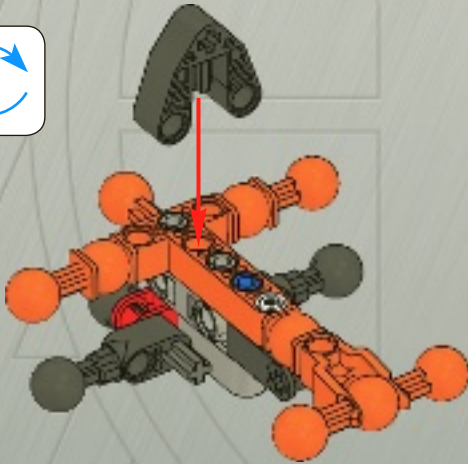

6

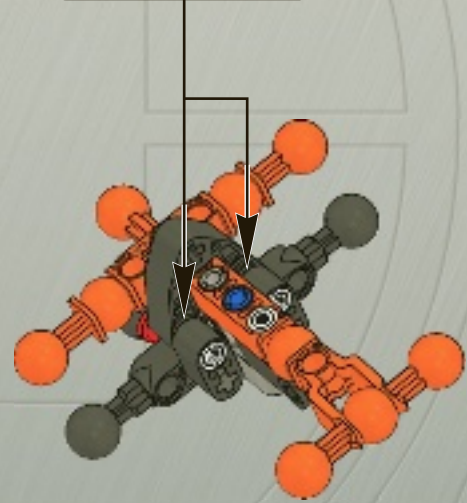
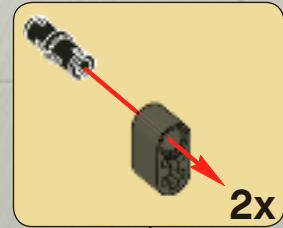

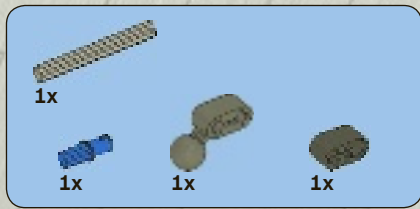

7

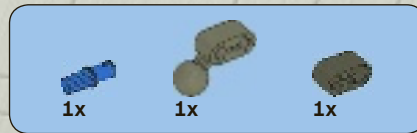
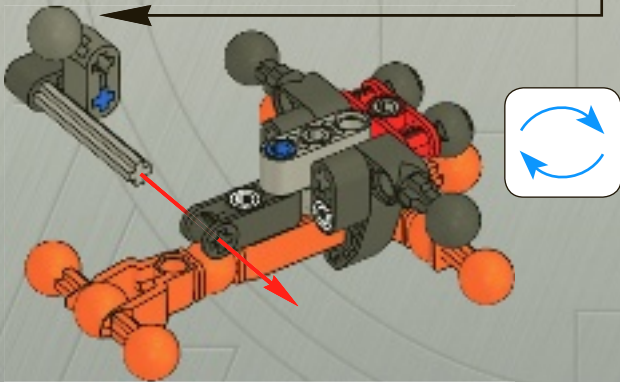
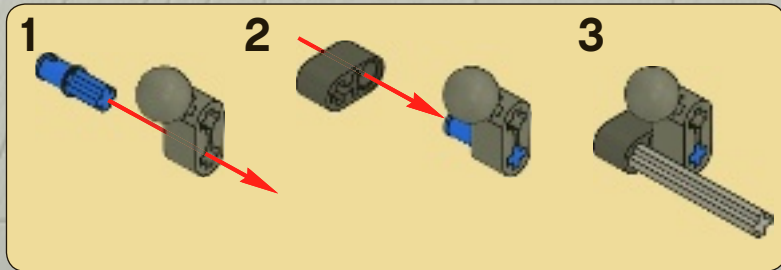

8

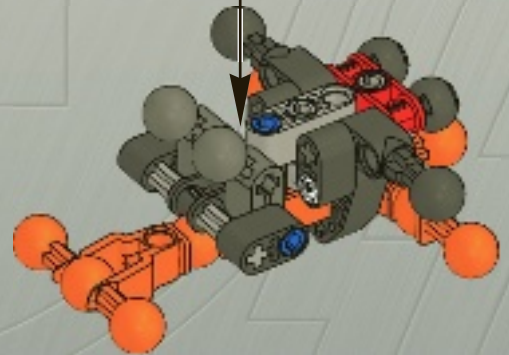

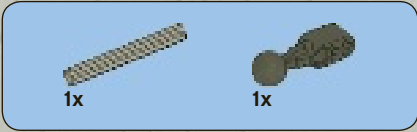

1

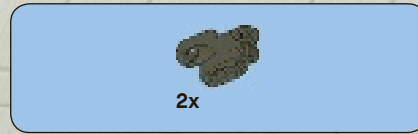
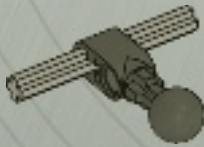

2

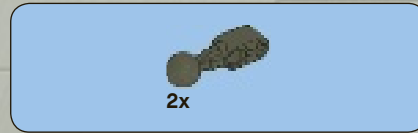
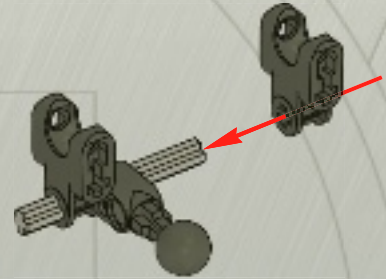

3

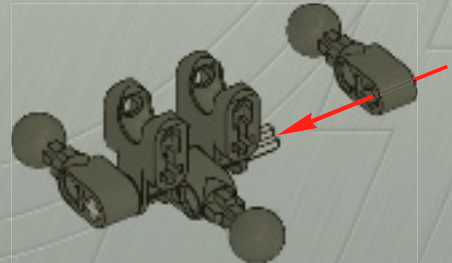



4

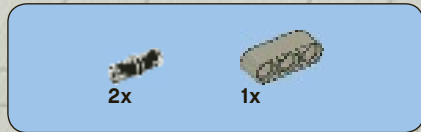
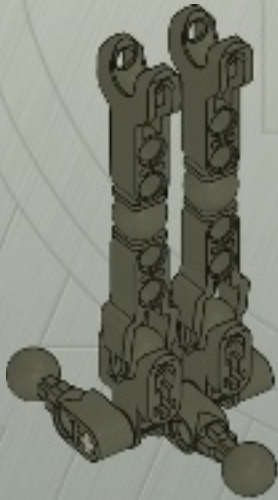

5

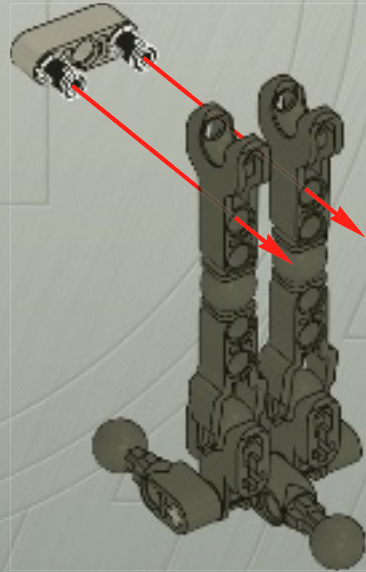
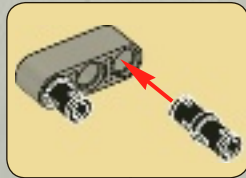

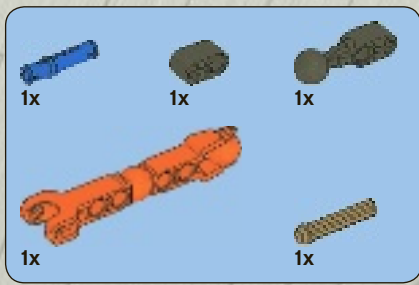

6

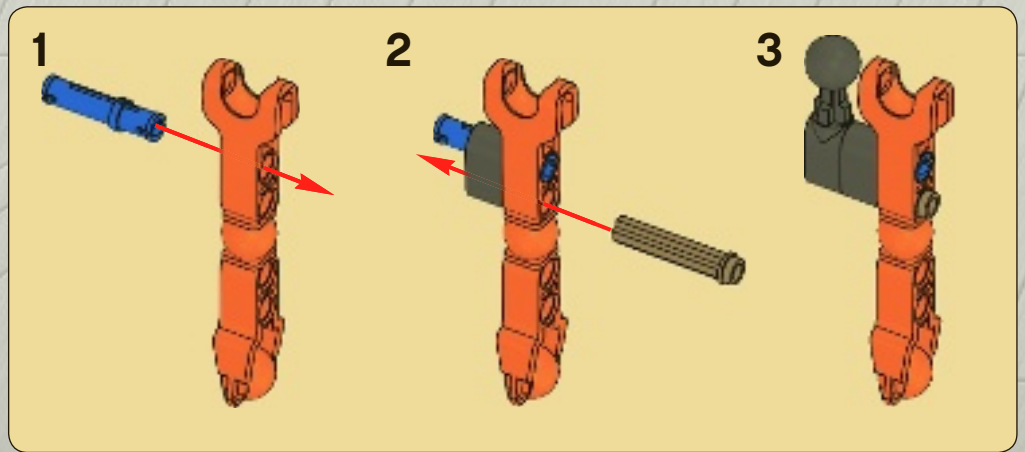



7

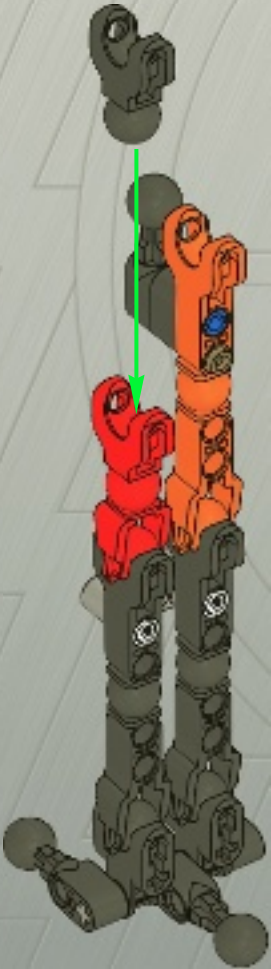

8

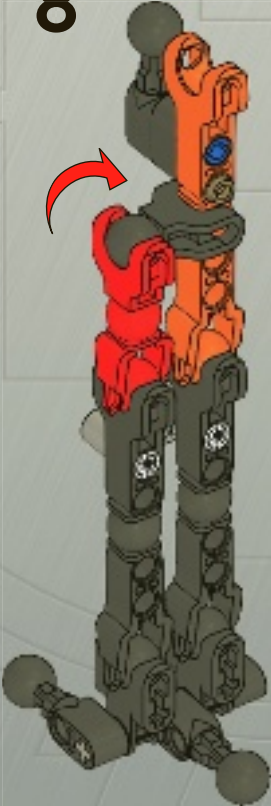

9

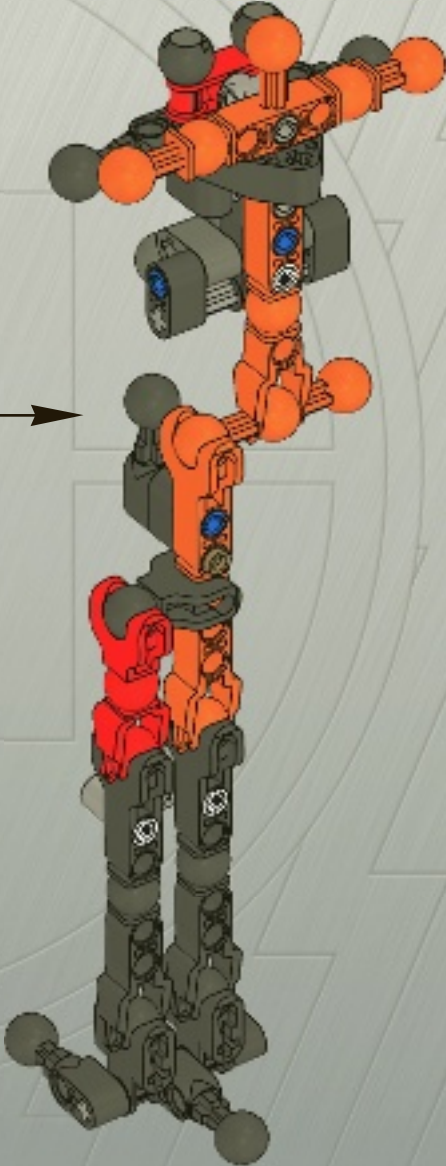

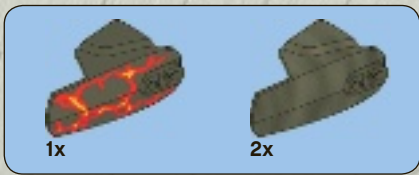

10

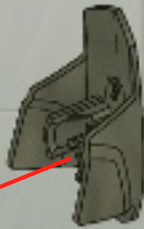
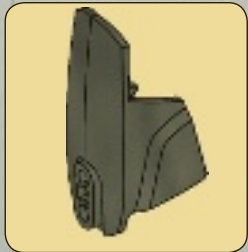
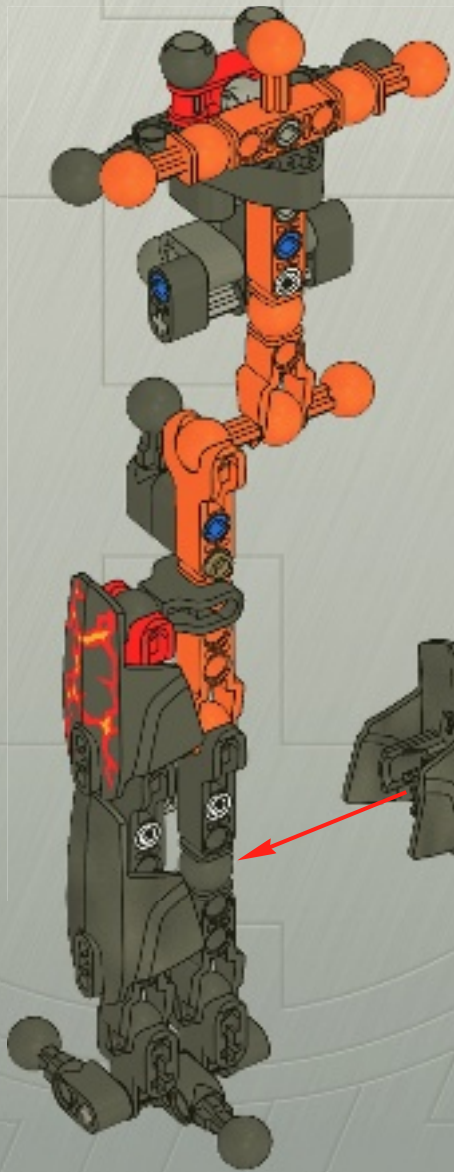

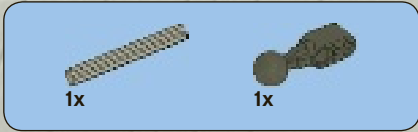

1

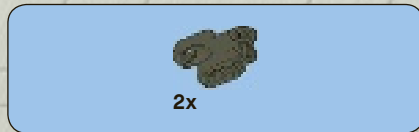
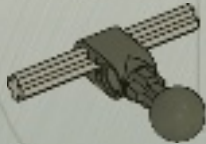

2

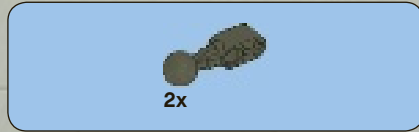
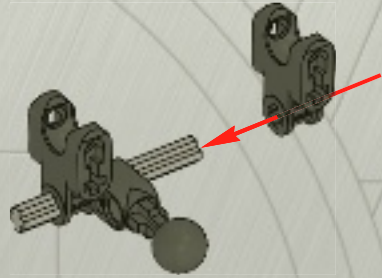

3

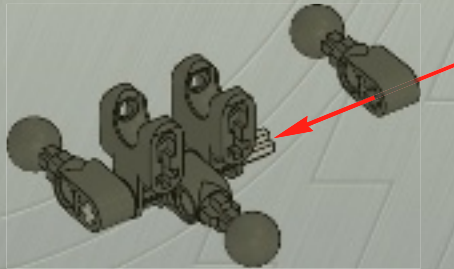

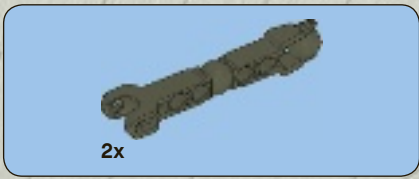

4

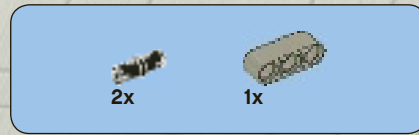
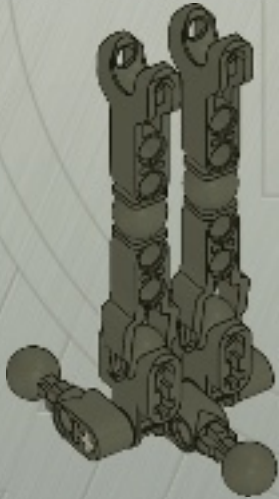

5

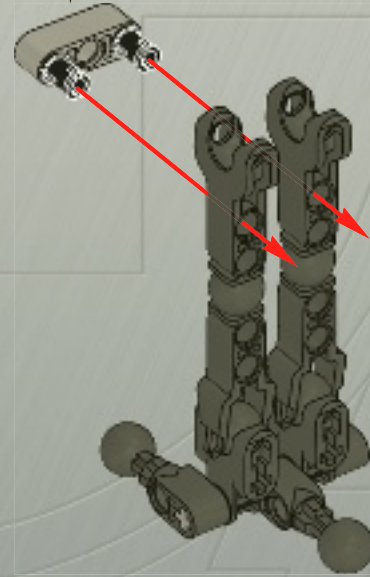
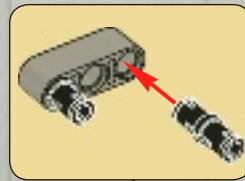



1x



1x

6



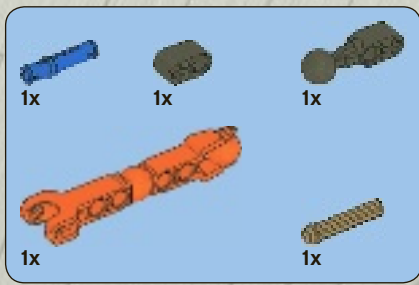

7

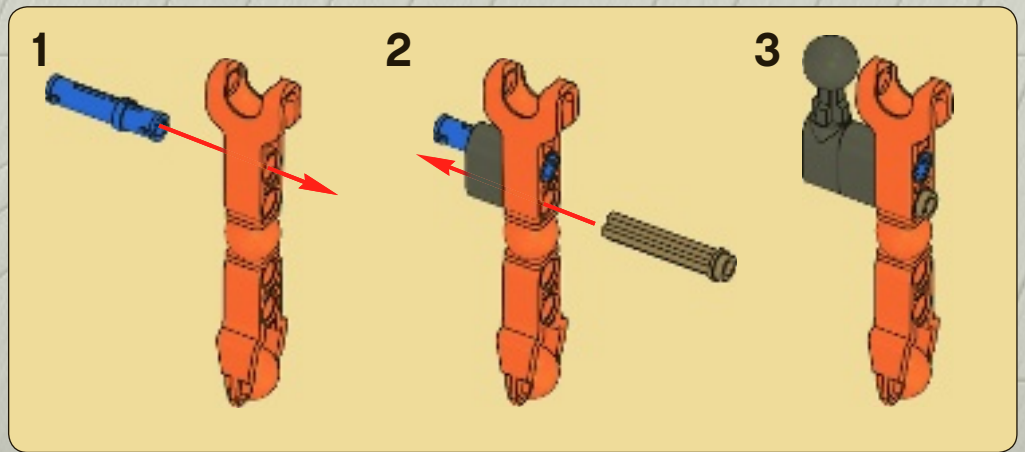

8

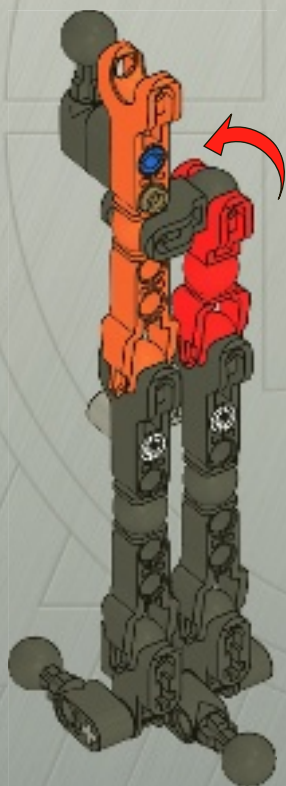

11

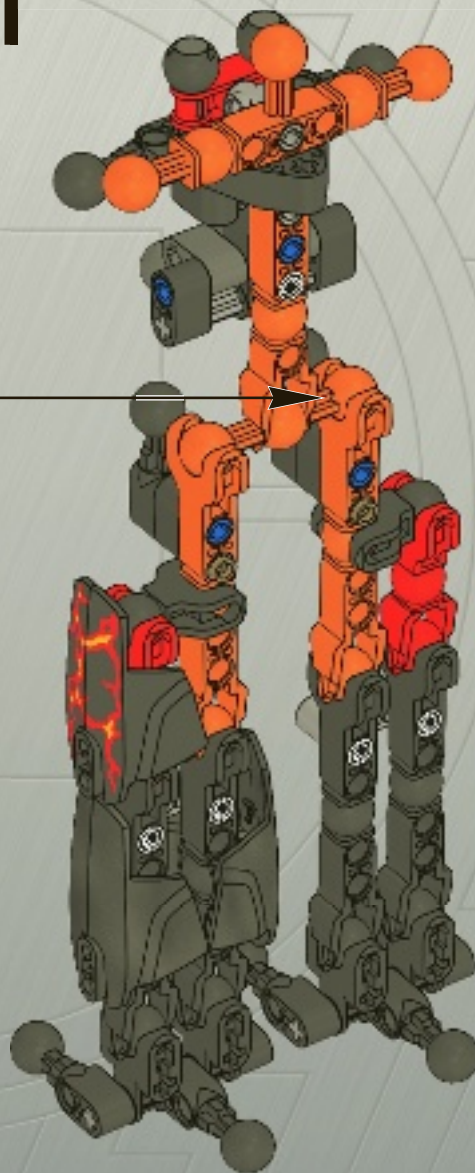



12

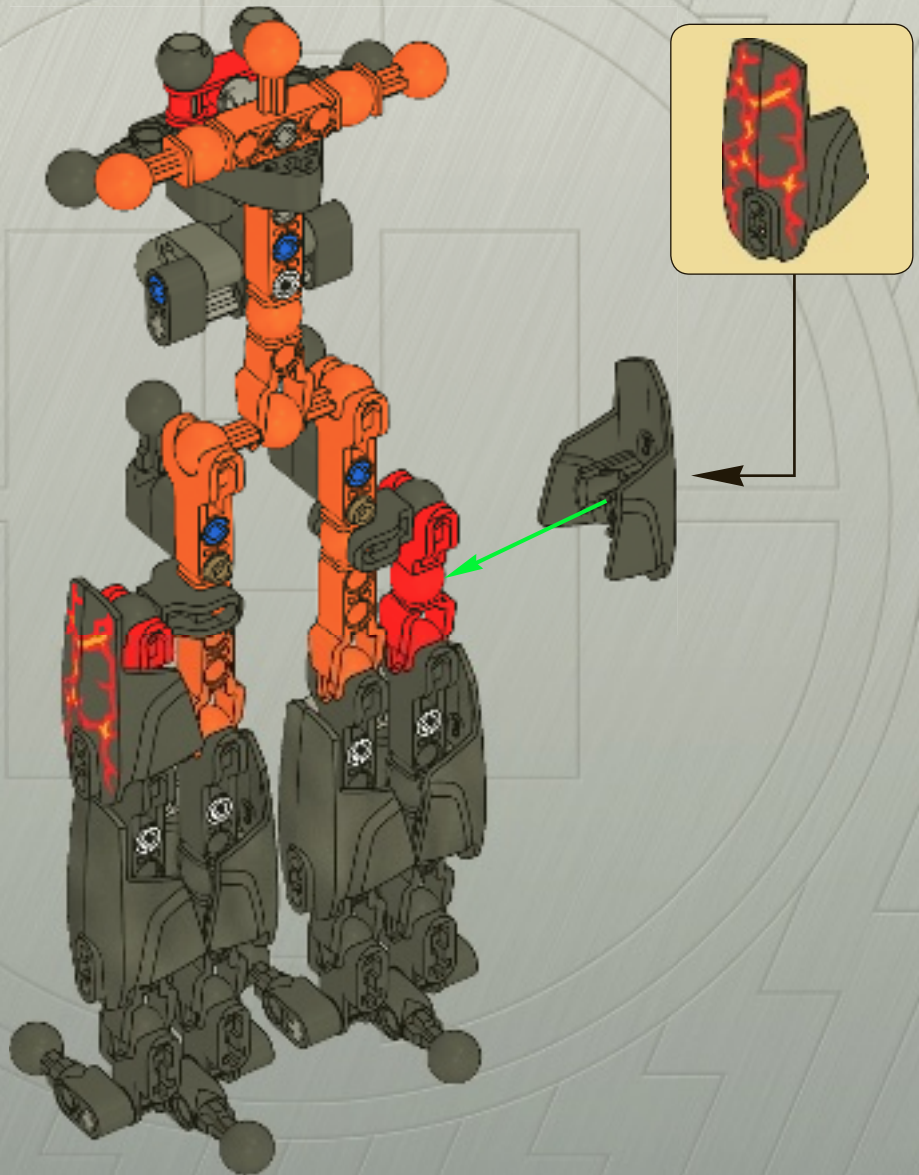

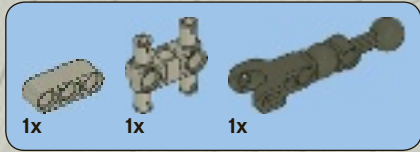

1

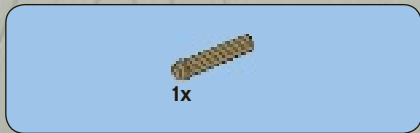
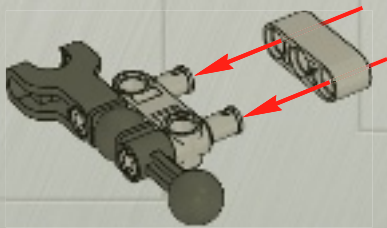

2

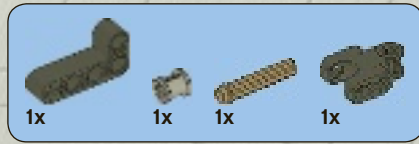
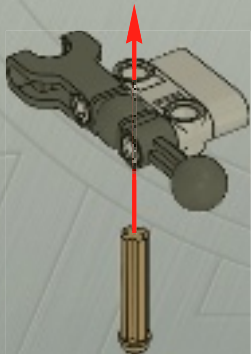

3

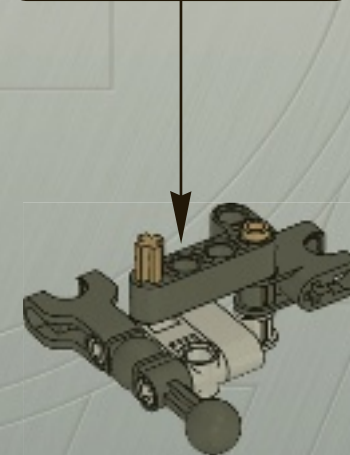
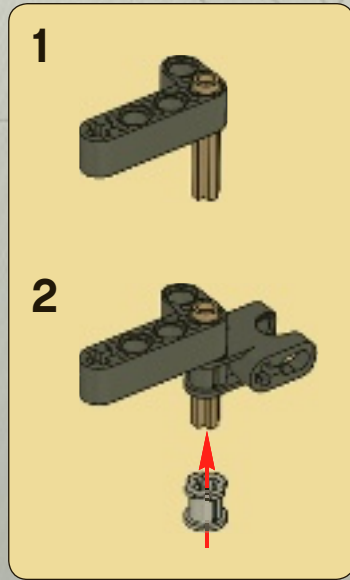

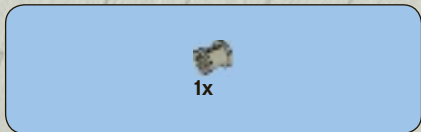

4



13

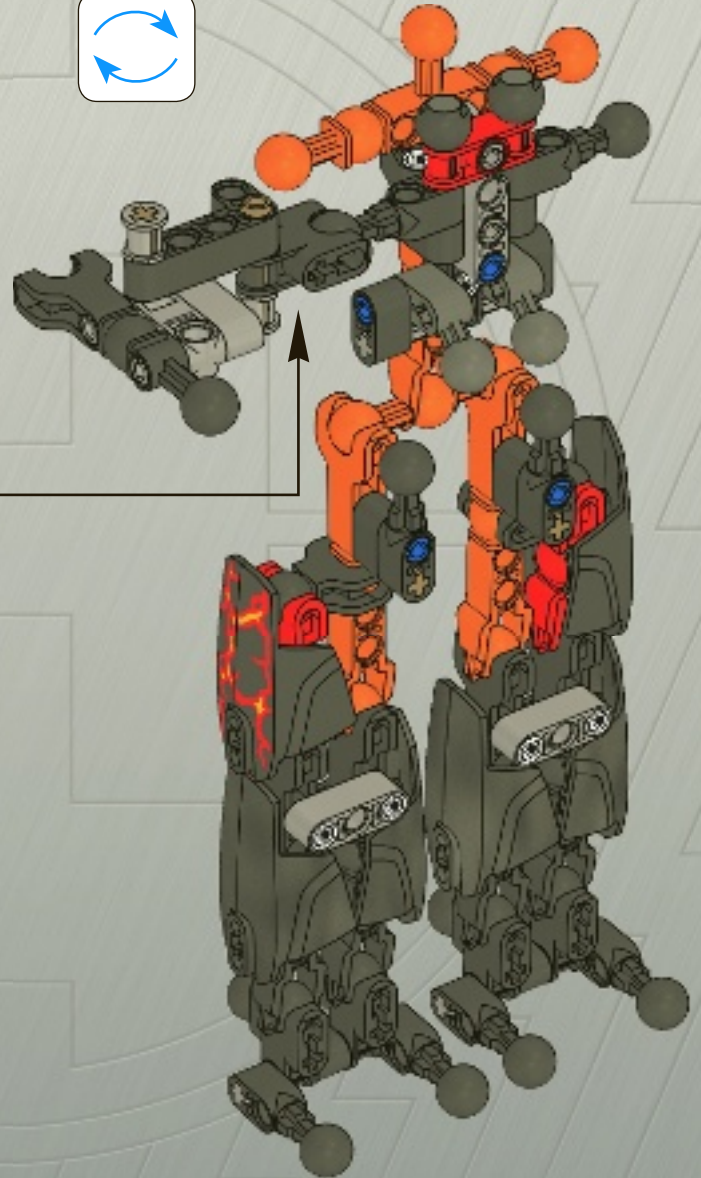

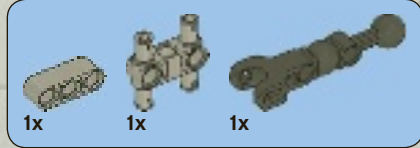
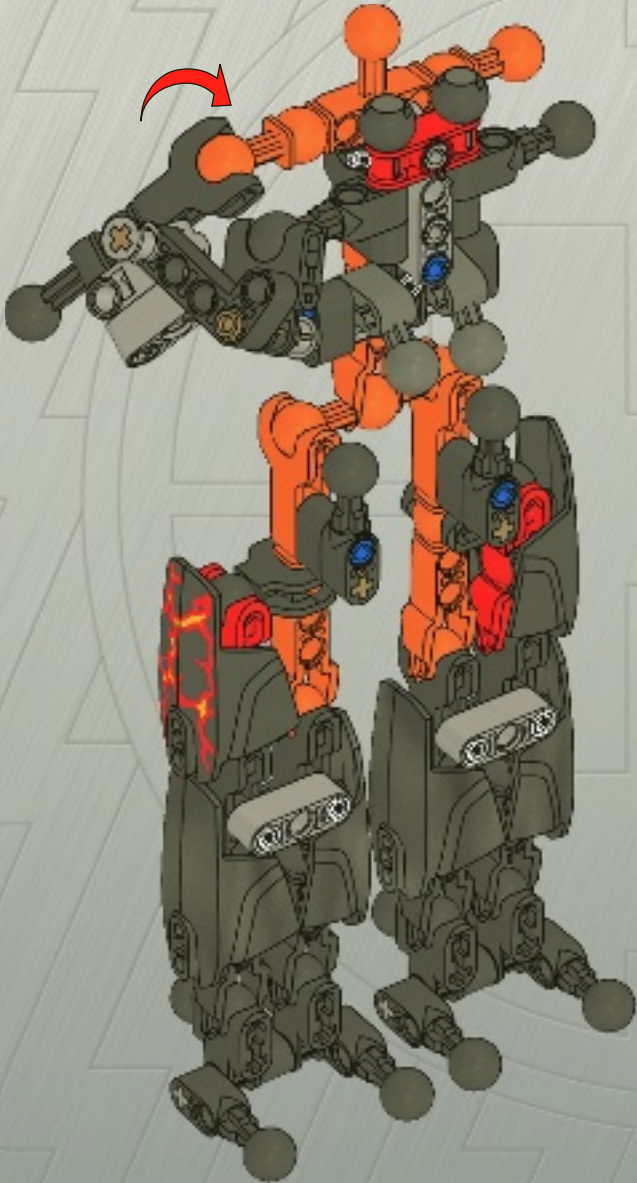

1

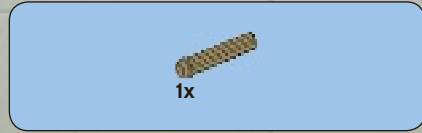
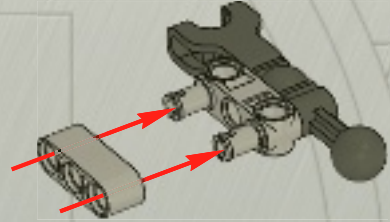

2

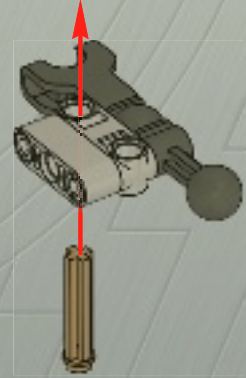

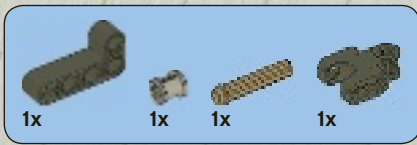

3

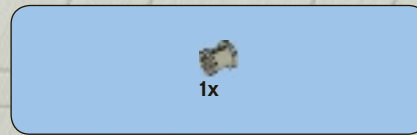
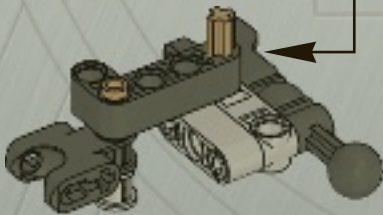
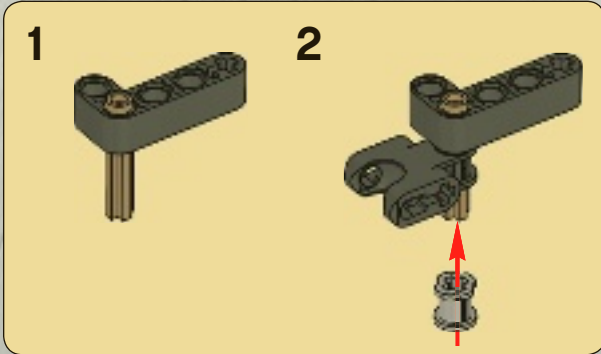

4



15

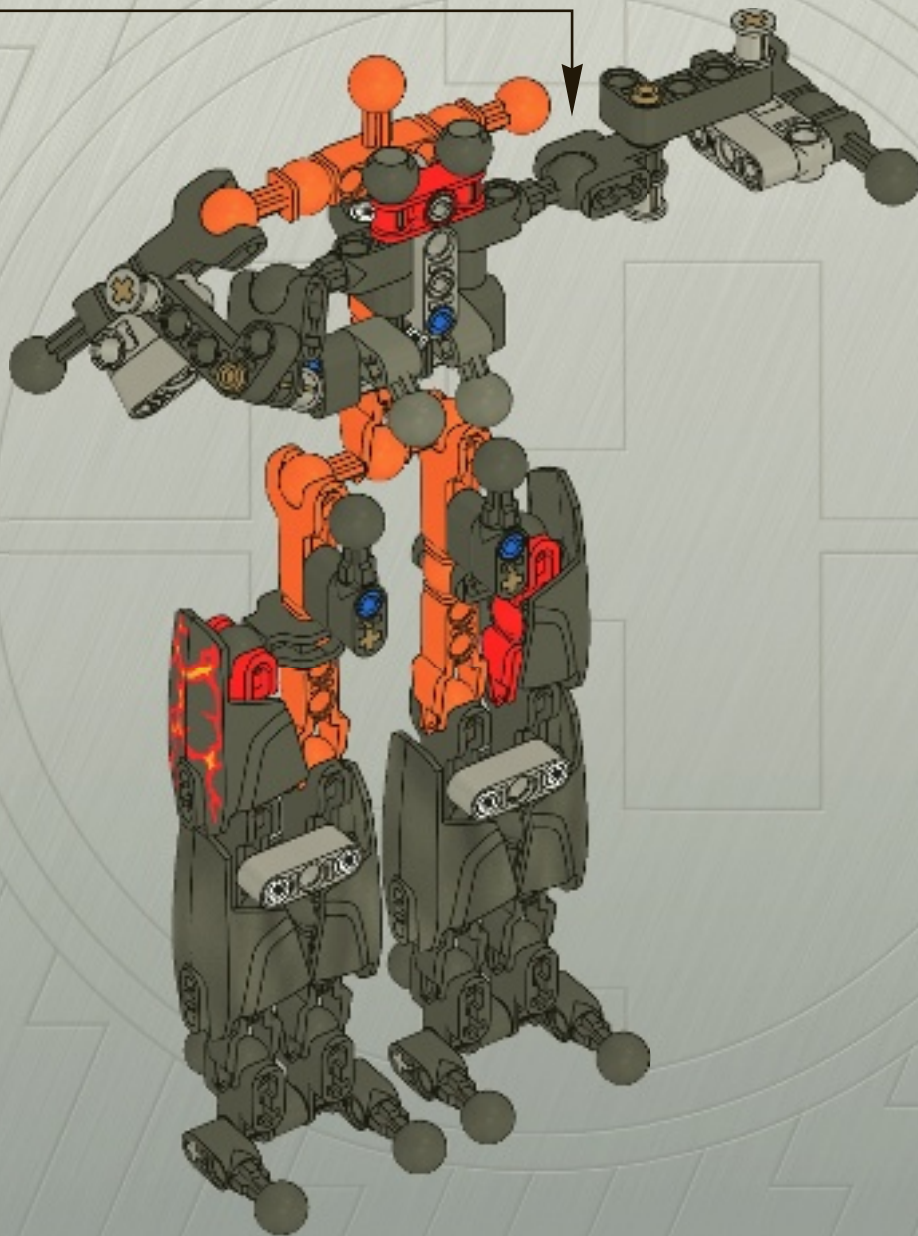

16

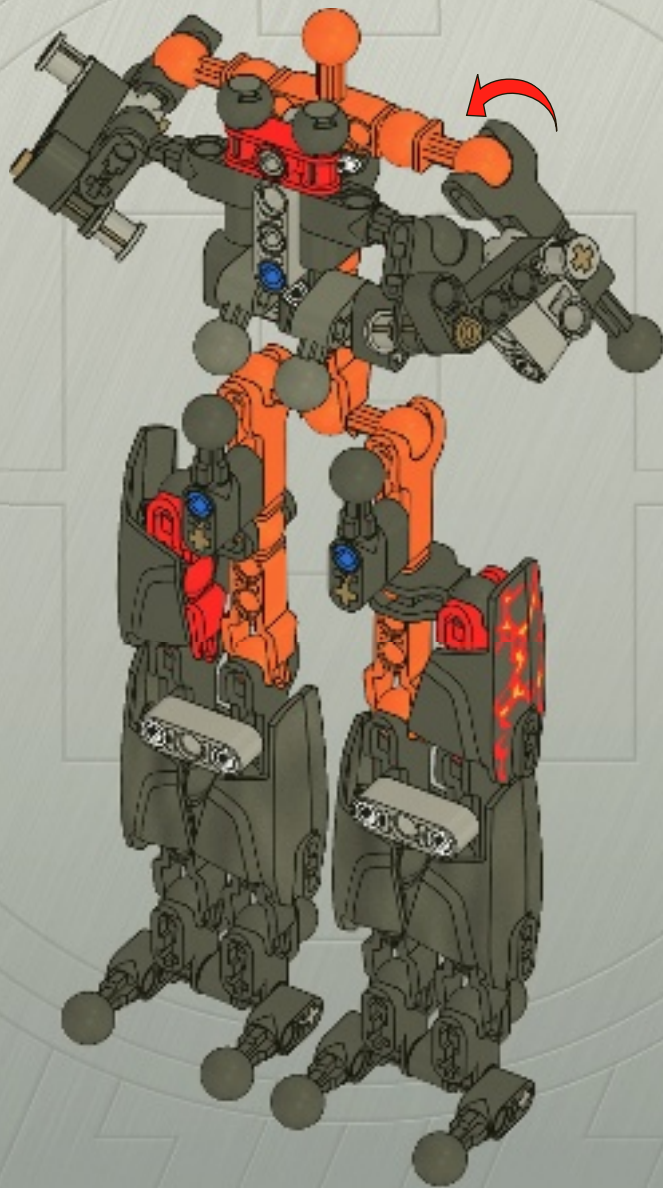



2x

17

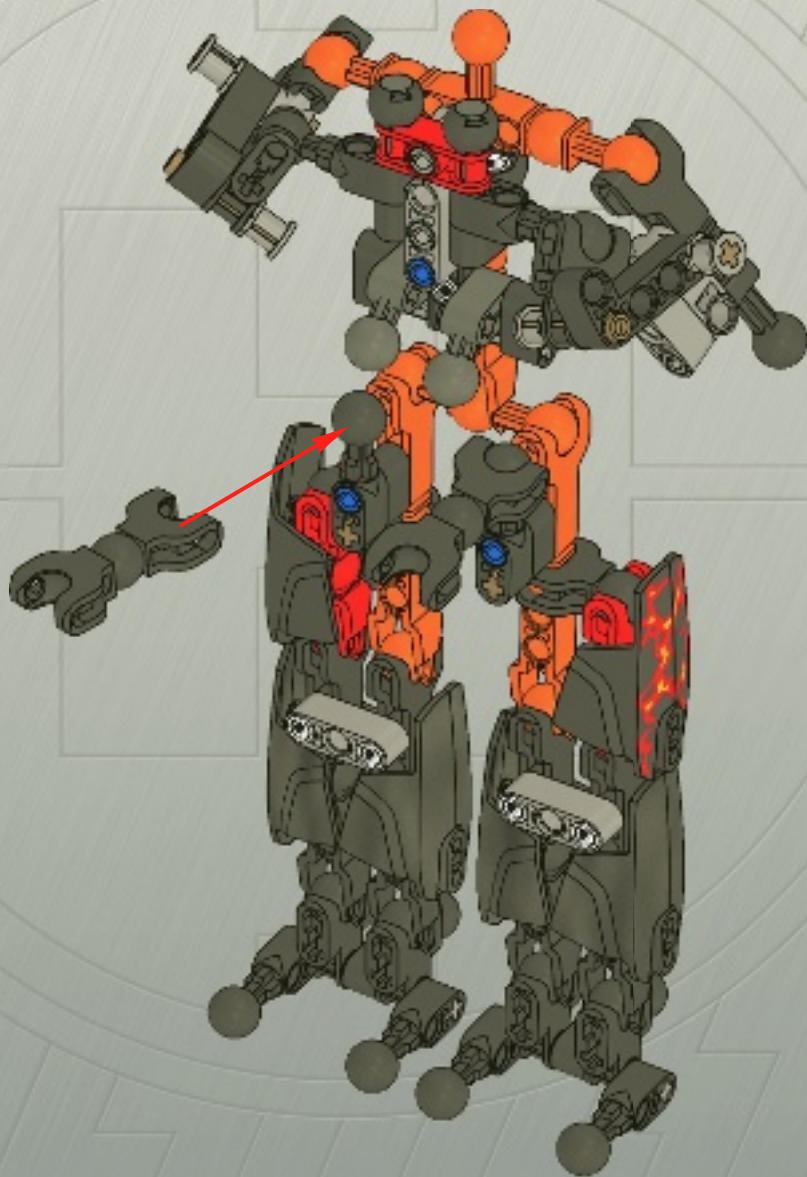

18

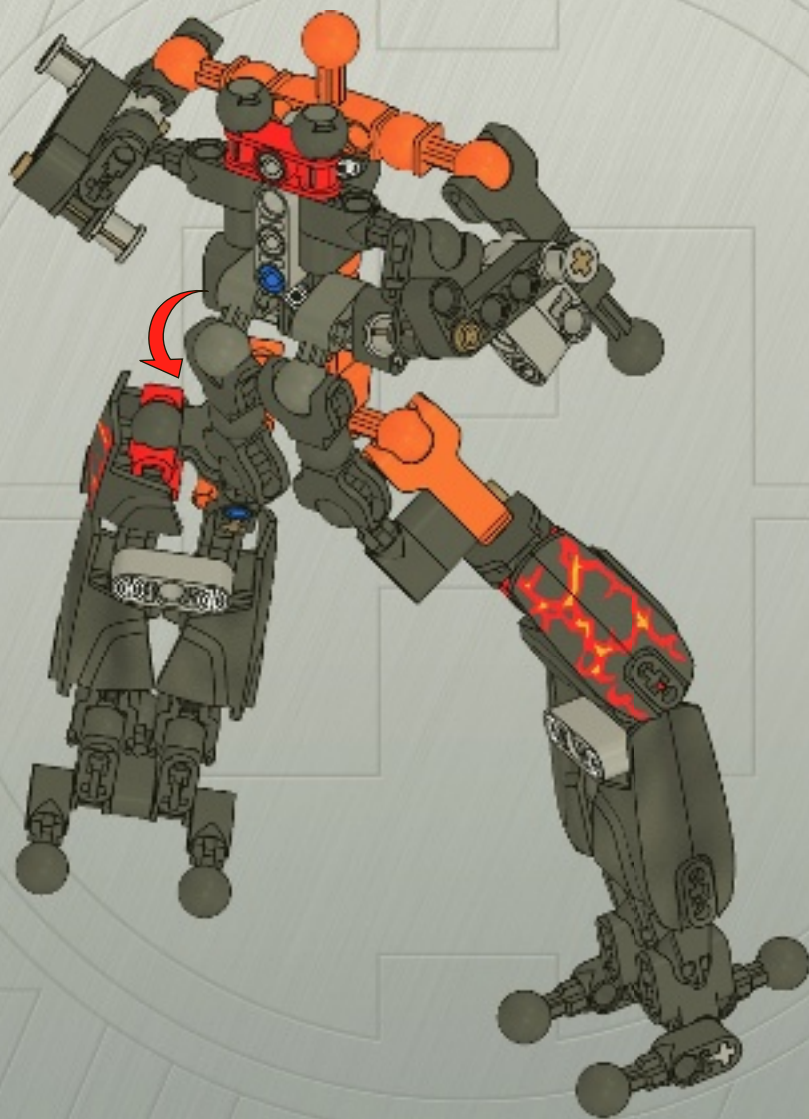



1

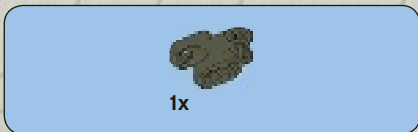
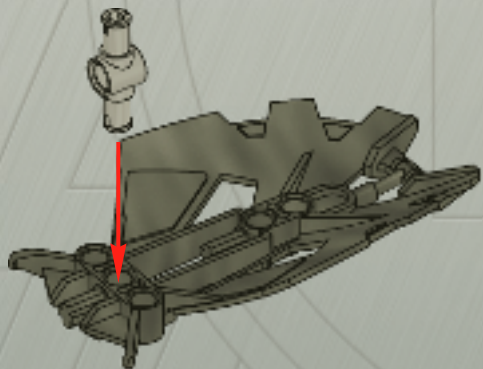

2

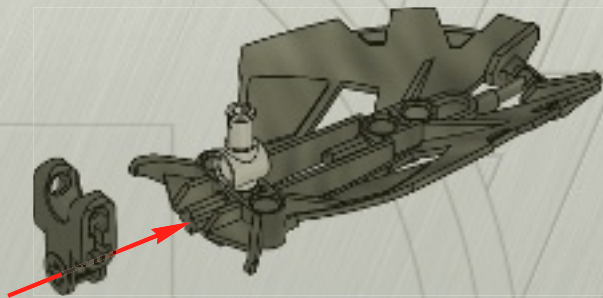

3

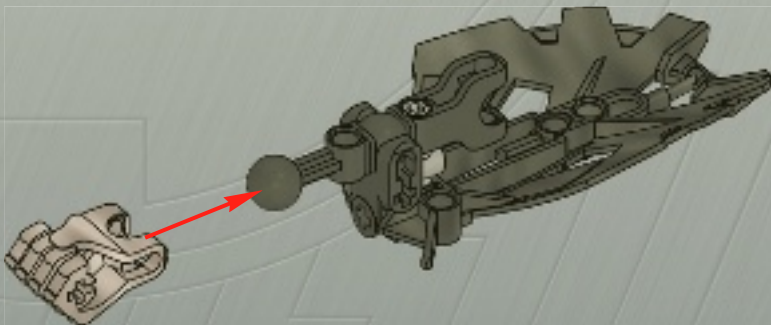

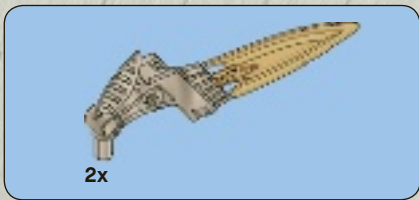

4

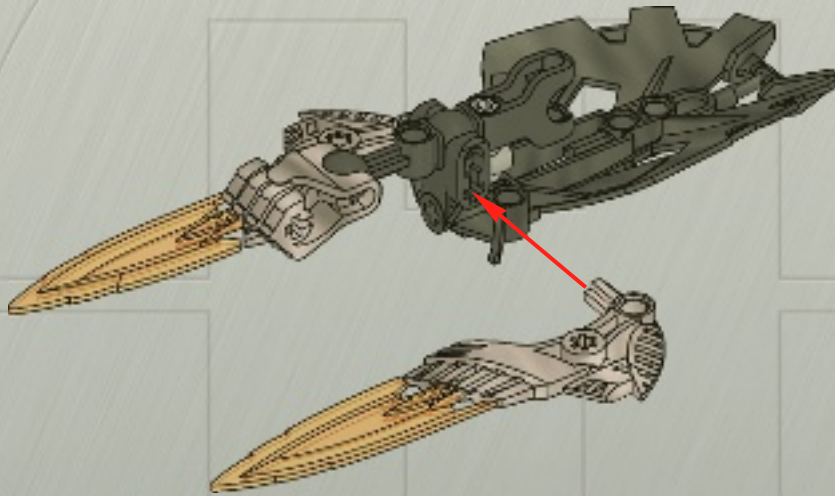

19

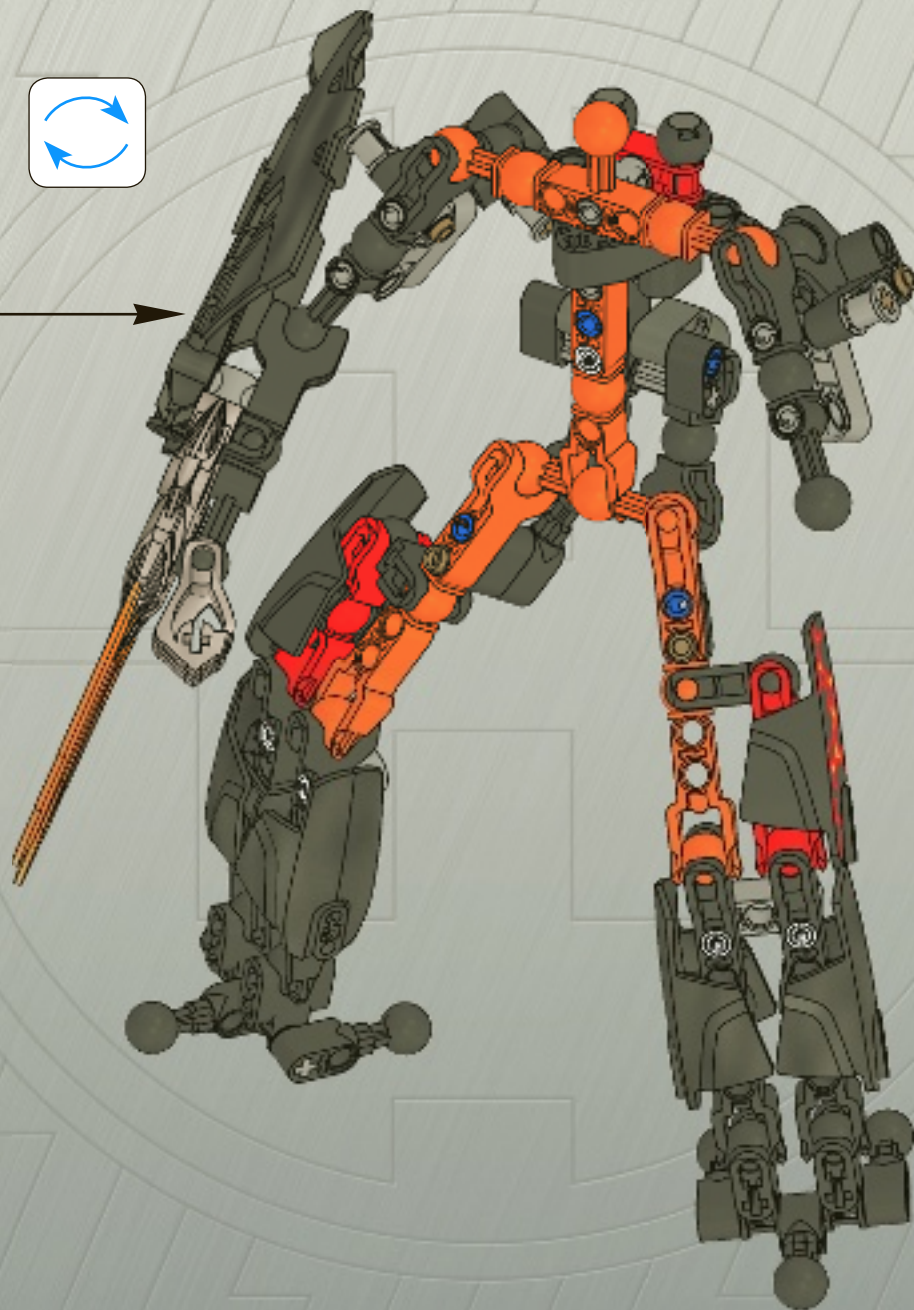



1

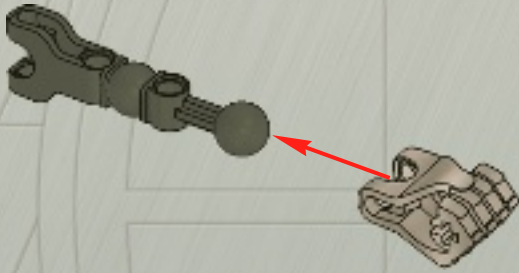

2

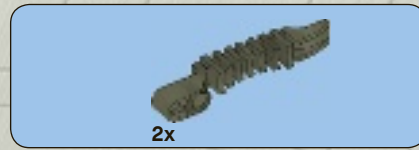

3

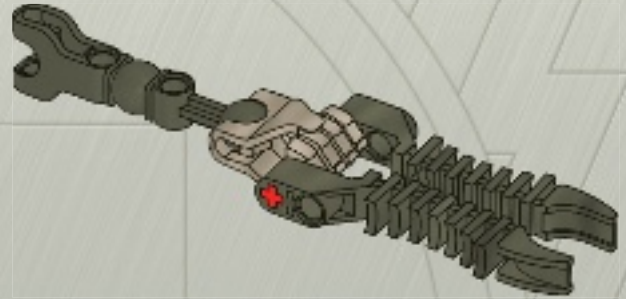

4

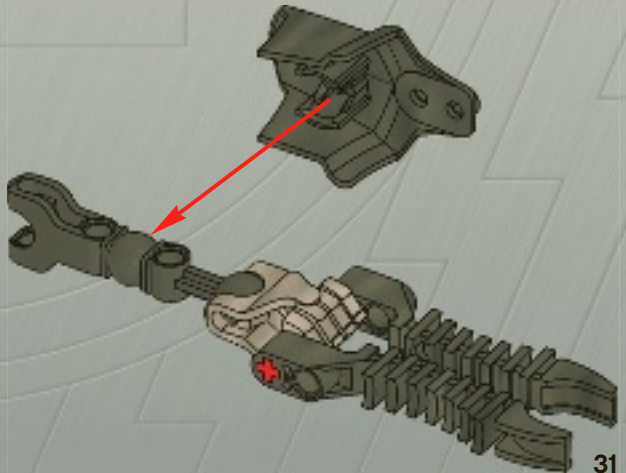

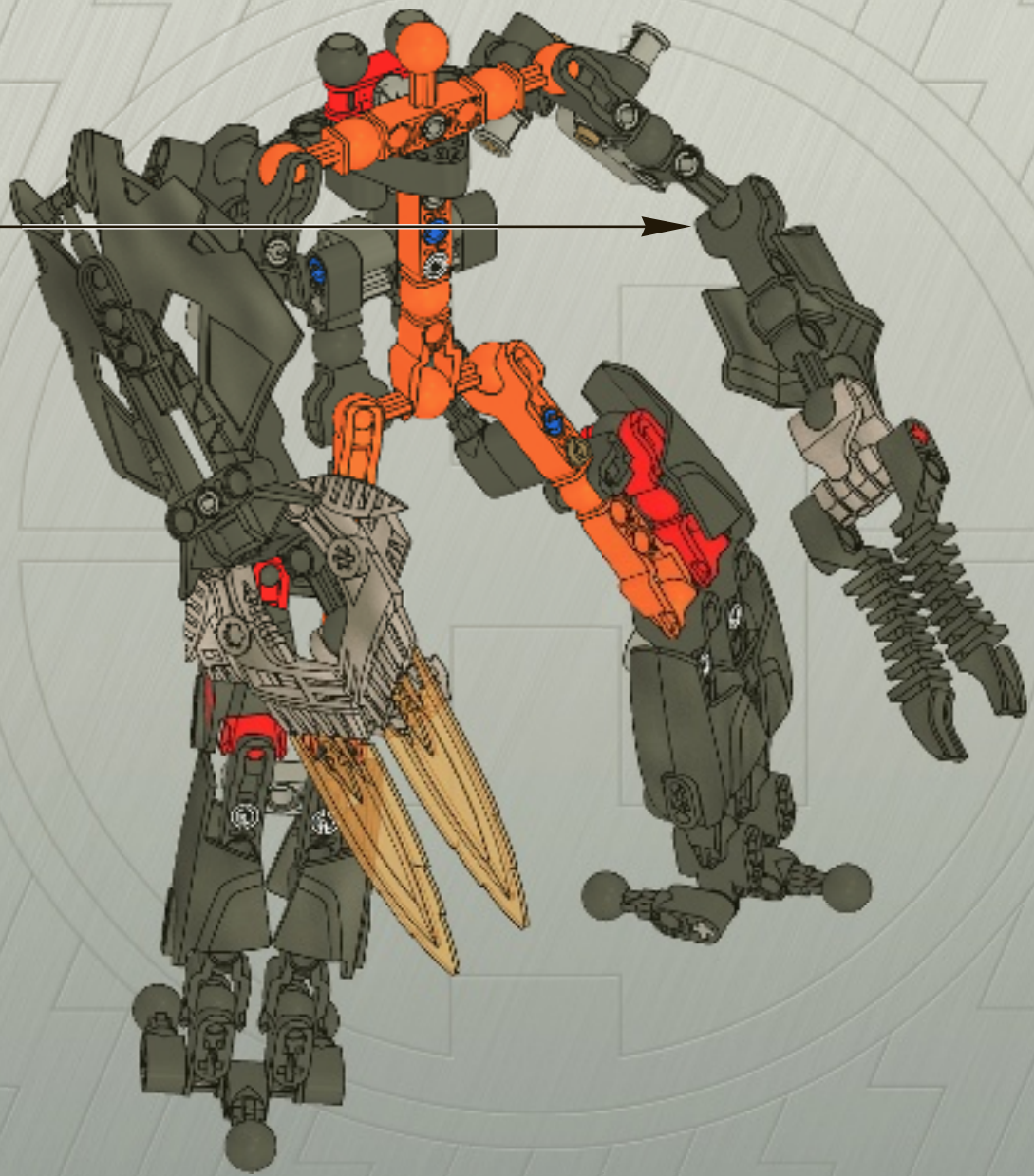

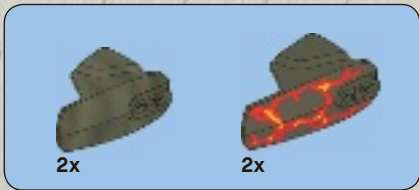

21

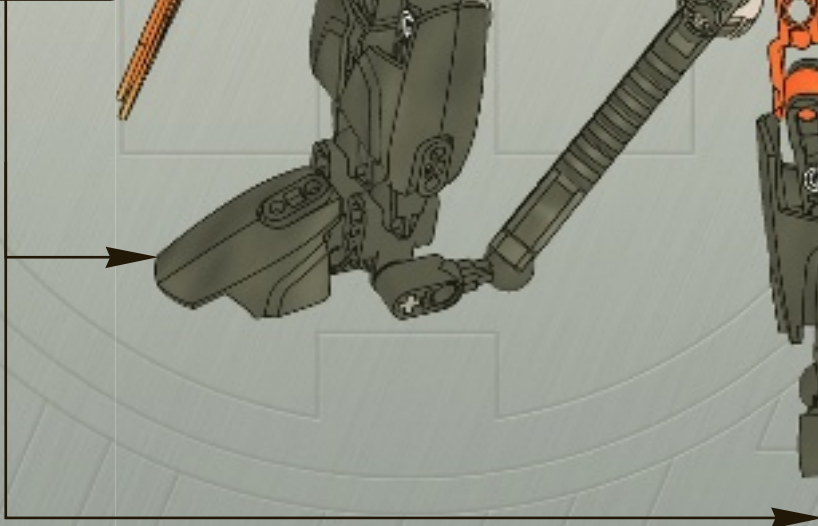



22

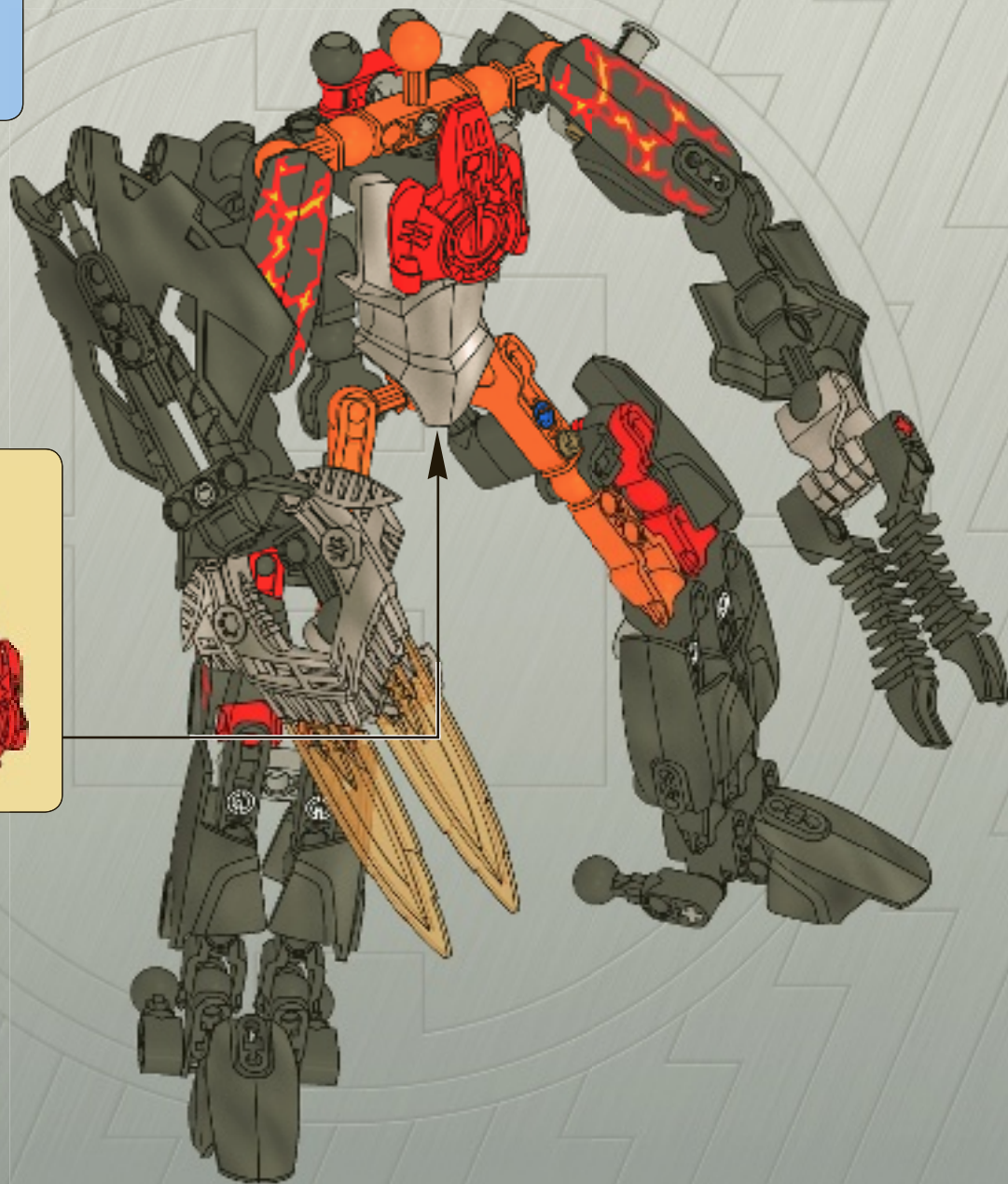
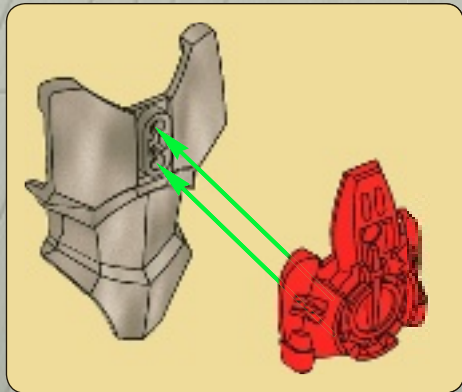



2x

23

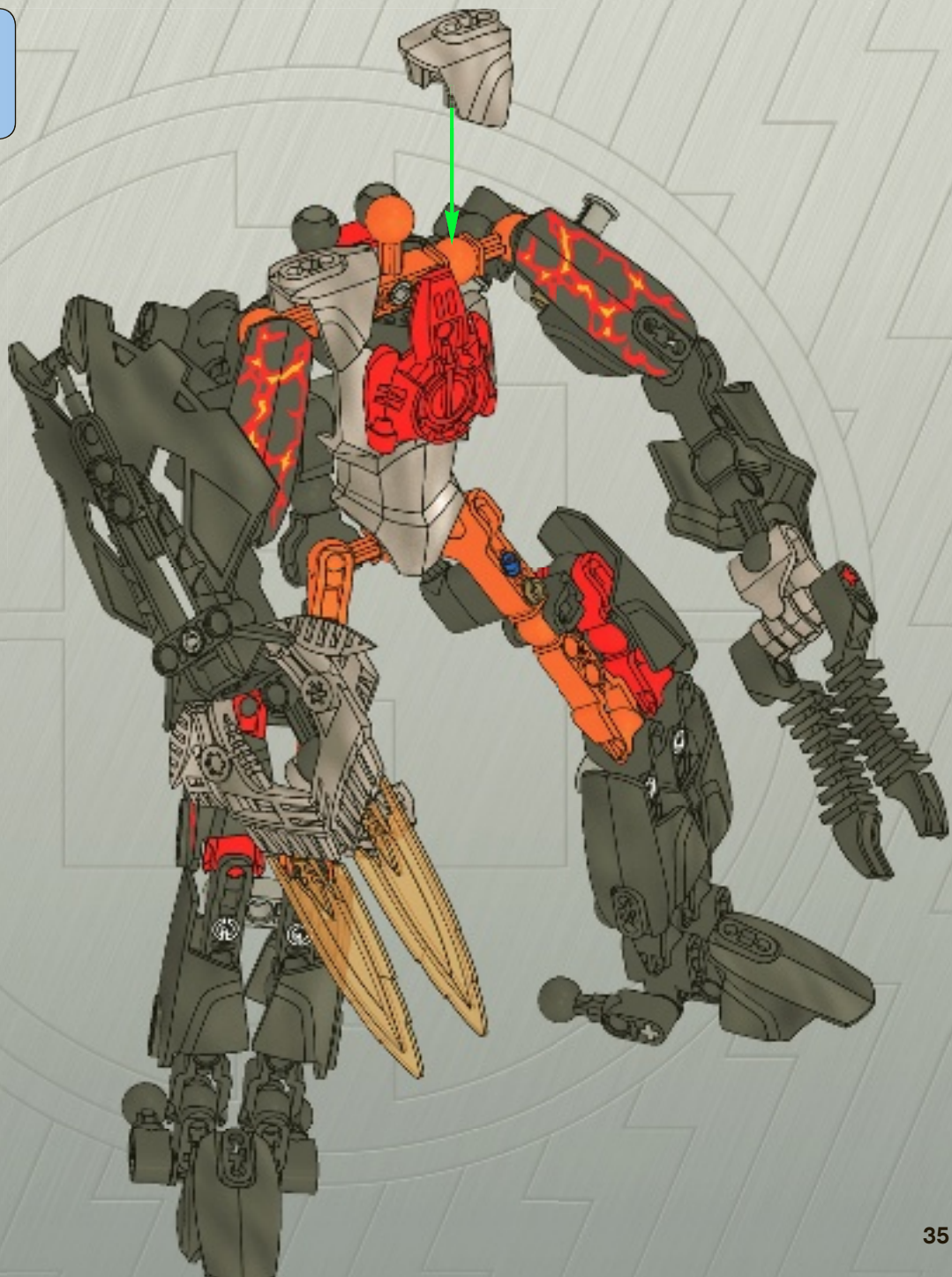



1

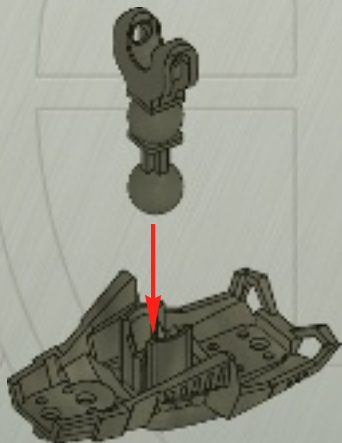

2

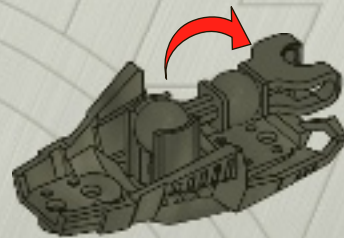

3

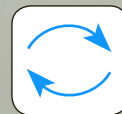

2x

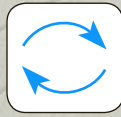

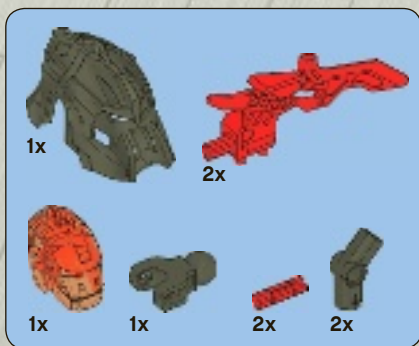

24

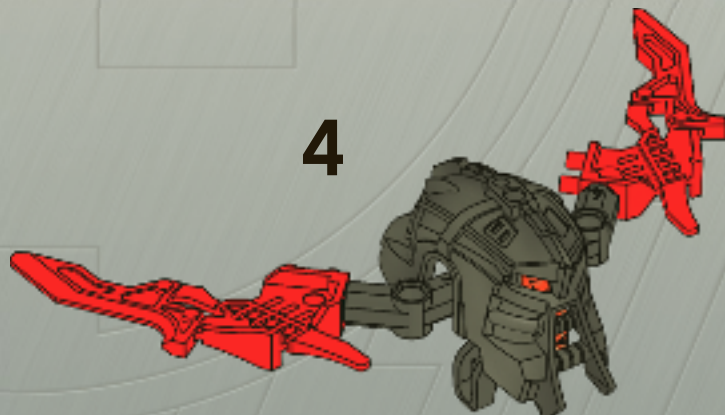
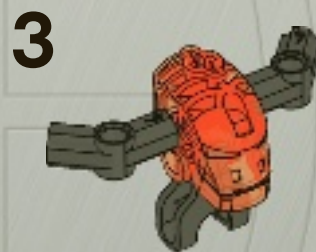

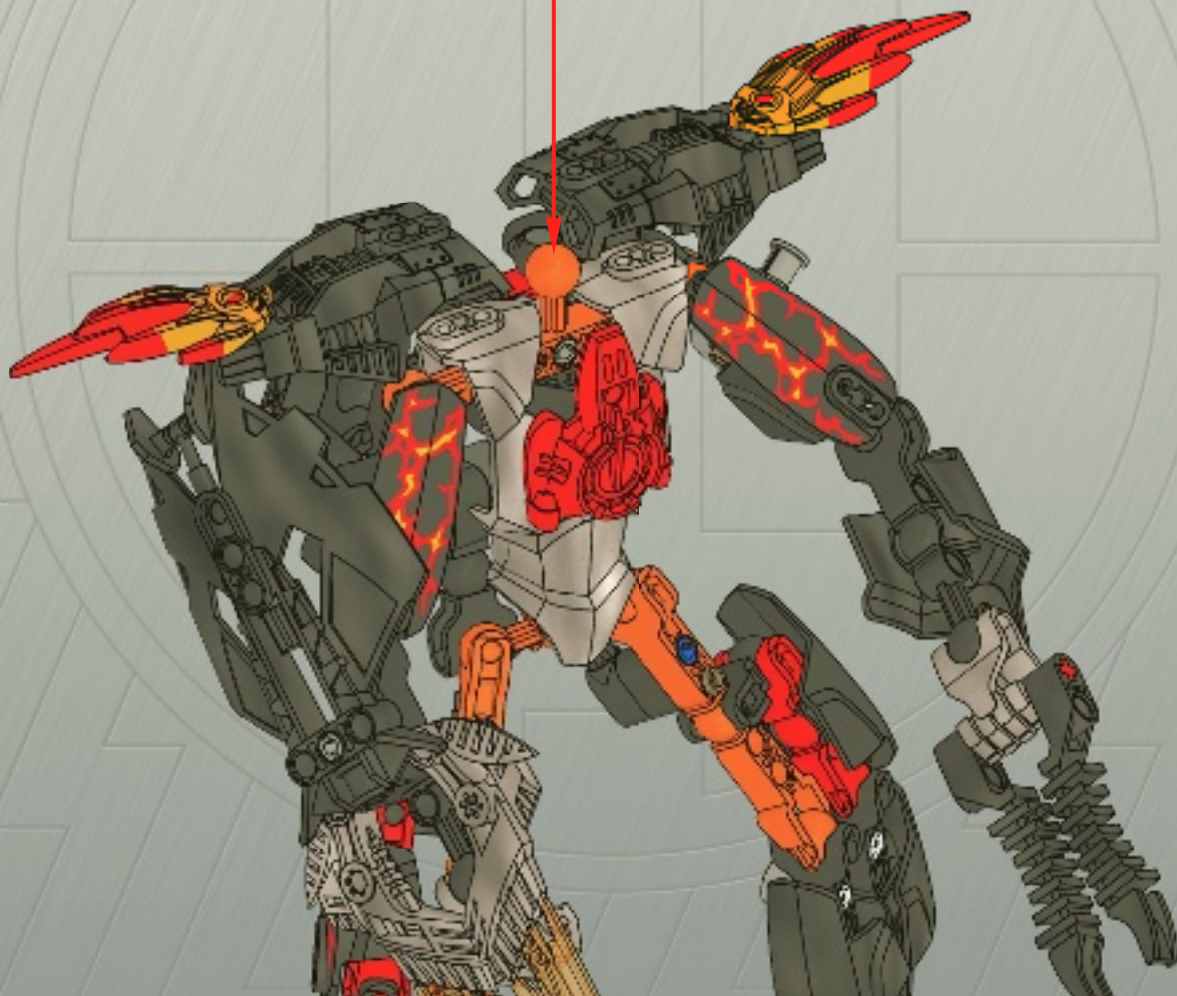
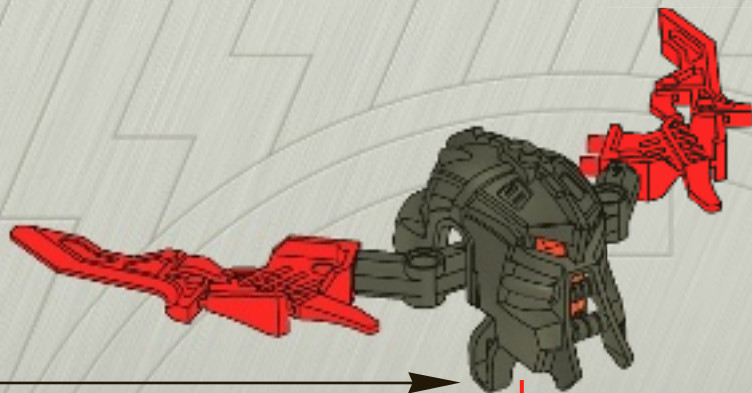
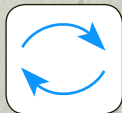



25

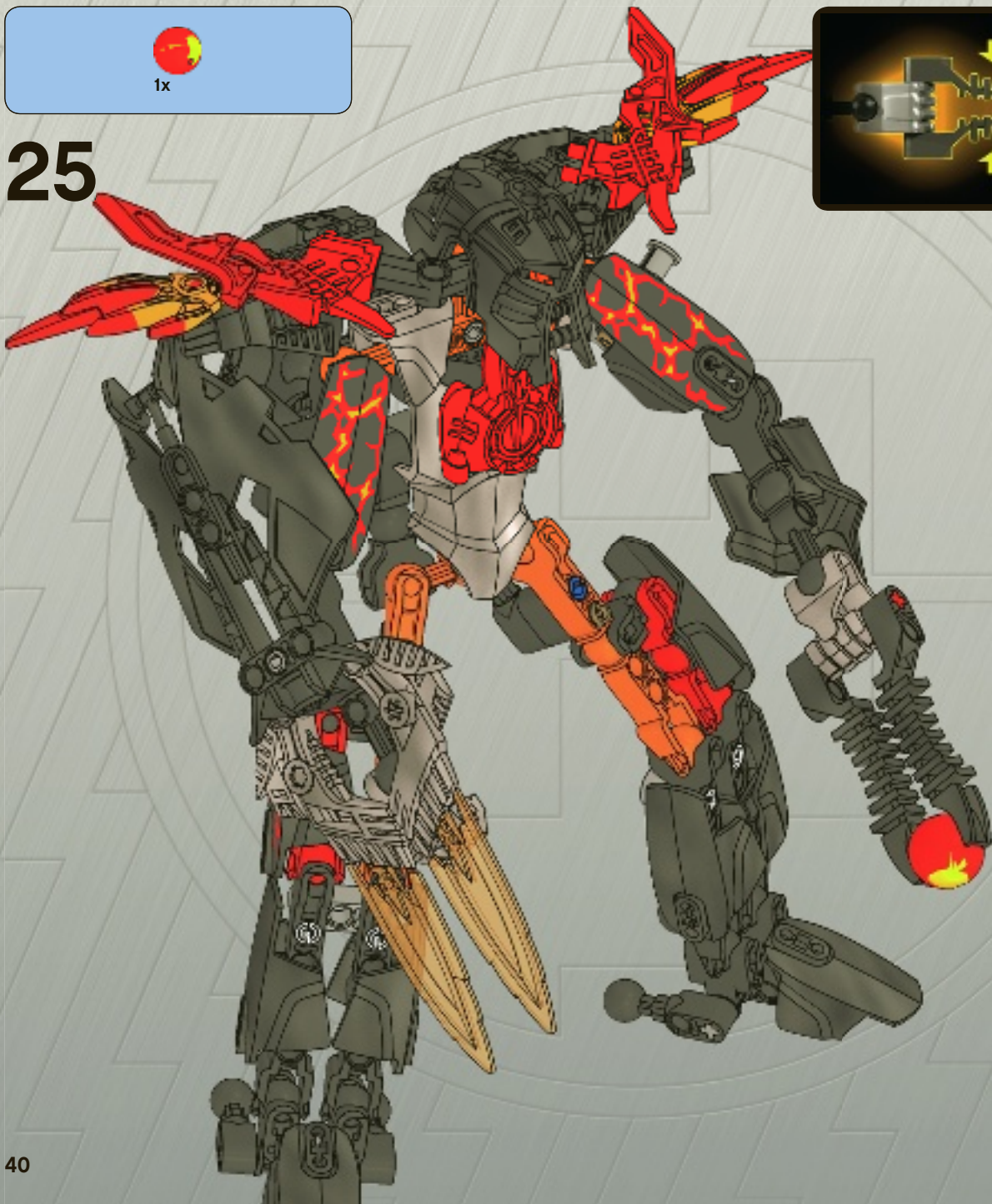

1x
4128598

2x
4603782

2x
4611806

1x
4622390

2x
4591604

1x
4591614

4x
4142865

2x
4206482

3x
4514553

6x
4515185

2x
4120017

1x
4173970

1x
4497946

2x
4286267

7x
4610948

10x
4560108

3x
4593557

2x
4593555

2x
4593567

4x
4593553

4x
4593558

4x
4632631

2x
4121610

7x
4121715

1x
4540702

1x
4609809

2x
4609819

6x
4566927

5x
4211655

1x
4560175

4x
4211622

3x
4225033

3x
4211639

2x
4289258

2x
4560177

2x
4632610

2x
4619077

2x
4617725

1x
4632589

1x
4611812

1x
4614168

2x
4609686

2x
4609731

1x
4615593

2x
4632641

4x
4632628

Customer Service
Kundenservice
Service Consommateurs
Servicio Al Consumidor

www.lego.com/service or dial

 : 00800 5346 5555
: 1-800-422-5346



LEGO HERO FACTORY

HOME PRODUCTS DOWNLOADS FUN ZONE STORY GALLERY

CALL CENTER

HERO FACTORY CALL CENTER

SUBMIT YOUR OWN MISSION

MEDIA CENTER

ABOUT HERO FACTORY

PRODUCTS

NEW AVAILABLE SOON!

LATEST NEWS

- Hero Factory is pulling the finishing touches on a new feature - creating your own ...
- The current galactic threat level is PCARL. There is life or so villain and great

REAL-TIME STATISTICS

Teams Currently On Mission	365
Villains & Minions Captured or Defeated This Week	2,543
Total Missions Completed	11,234,742
Mission Success Ratio	88%
New Heros Commissioned Today	3
Today's Weather in Makurovo City	Windy day

Customer Service About Us Educators Parents LEGOLAND Site Index Legal Notice

LEGO, the LEGO logo, DUPLO, BIONICLE, MINDSTORMS, the BELVILLE, KNIGHTS' KINGDOM and EXO-FORCE logos, the Brick and Knob configurations and the Minifigure are trademarks of the LEGO Group.
© 2010 The LEGO Group. All rights reserved. Use of this site signifies your agreement to the terms of use.





LEGO

HERO FACTORY



HERO RECON TEAM



HeroFactory.LEGO.com

Coming spring 2011

DE: Ab Frühling 2011, FR/FRCA: Sortie au printemps 2011, ES/ESSA: Disponible en primavera de 2011, PT: Próxima primavera 2011, HU: 2011 tavaszán érkezik.



www.LEGOclub.com



LEGO® Club Email

LEGO club™

FREE! GRATIS! GRATUIT!



LEGO® Club Magazine

SIGN UP ONLINE!

www.LEGOclub.com



00800 5346 5555*



1-866-534-6258 • 1-877-518-5346

US & Canada only

Canada seulement

* Freephone. Mobile charges may apply.
* Numéro sans frais. Des frais peuvent s'appliquer avec les téléphones cellulaires.
* Gebührenfrei. Kosten für Anrufe aus Mobilfunknetzen können abweichend.
* Gratis telefonnummer vanaf vaste lijn.
* Det er et gratis nummer, når du ringer fra fasttelefon.
* Det är gratis, när du ringer från en fast telefon.
* Numéro sans frais. Des frais peuvent s'appliquer avec les téléphones portables.

YES! I want to join the LEGO® Club FREE! **OUI ! Je veux m'abonner au LEGO® Club GRATUITEMENT !**

Ja! Ich möchte Mitglied im kostenlosen LEGO® Club werden. Ja! Ik wil graag GRATIS lid worden van de LEGO® Club.

Ja! Jeg ønsker å melde meg inn i LEGO® Club gratis! Ja! Jeg vill gå med i LEGO® Club GRATIS!

First name · Prénom
Vorname · Voornaam
Fornavn · Förnamn

--	--	--	--	--	--	--	--	--	--	--	--	--	--	--	--	--	--	--	--

Last name · Nom de famille
Name · Achternaam
Etternavn · Efternamn

--	--	--	--	--	--	--	--	--	--	--	--	--	--	--	--	--	--	--	--

Date of Birth · Date de naissance
Geburtsdag · Geboortedatum
Fødselsdato · Födelsdatum

--	--	--	--	--	--	--	--

Boy · Garçon · Junge ·
Jongen Gutt · Pojke

Girl · Fille Mädchen ·
Meisje Jente · Flicka

Street · Adresse
Straße, Hausnr.
Straat, huisnr. ·
Adress

--	--	--	--	--	--	--	--	--	--	--	--	--	--	--	--	--	--	--	--

City · Ville
Ort · Woonplaats
Poststed · Postort

--	--	--	--	--	--	--	--	--	--	--	--	--	--	--	--	--

State
Prov.
County

--	--	--	--	--	--	--	--	--	--	--	--	--	--	--	--	--

Zip/Postcode · Code
Postal · PLZ · Postcode ·
Postnummer

--	--	--	--	--	--	--	--	--	--	--	--	--	--	--	--	--

Country
Pays ·
Land

--	--	--	--	--	--	--	--	--	--	--	--	--	--	--	--	--

Email · Courriel ·
E-Mail · E-post

--	--	--	--	--	--	--	--	--	--	--	--	--	--	--	--	--	--	--	--

Mail to: / Poster à: LEGO® Club
P.O. Box 1157
Enfield, CT USA
06083-1157



Mail to: LEGO® Club
33 Bath Road
Slough SL1 3UF
United Kingdom



Per Post an: LEGO® Club
Postfach 14 15
D-36243 Niederaula



Stuur op naar: LEGO® Club
Postbus 40250
3504 AB Utrecht



Poster à: LEGO® Club
21 rue de la banque
75 002 PARIS
FRANCE



Send til: LEGO® Club Norge
Postboks 58
1314 Vøyennga



Skicka till: LEGO® Club Sverige
Ubox 841
202 29 Malmö



Fill in your email address and we will send you a membership confirmation and monthly email newsletters. If you do not wish to receive the newsletters please tick here.
Remplis ton adresse e-mail et nous t'enversons une confirmation d'adhésion ainsi que le bulletin e-mail mensuel. Si tu ne désires pas recevoir le bulletin, coche cette case. Vul je e-mailadres in en we sturen je een bevestiging van je lidmaatschap en maandelijke e-mail nieuwsbrieven. Als je geen e-mail wilt ontvangen, kruis dan dit vakje aan.

Ich möchte per E-Mail den monatlichen LEGO Club Newsletter erhalten. Ønsker du at vi skal sende en liten hilsen til barnet ditt for å bekrefte medlemskapet, ber vi deg krysse av i feltet, samt oppgi e-postadressen som hilsenen skal sendes til. Om du vill att vi ska skicka en bekräftelse på ditt barns medlemskap, ber vi dig sätta ett kryss i rutan och skriva den e-post adress som bekräftelsen ska skickas till.

If you do not wish to receive additional mailings from the LEGO Club please tick here. Si tu ne désires pas recevoir de courrier supplémentaire du Club LEGO, coche cette case. Als je geen verdere post van de LEGO Club wilt ontvangen, kruis dan dit vakje aan.

Dersom du ønsker å motta annen informasjon fra LEGO Gruppen, setter du et kryss her.

The English language version of the magazine can only be mailed to addresses in the US, Canada, the UK, and Republic of Ireland. Club membership is valid for two years and includes free copies of the LEGO Club Magazine and e-mail newsletters. In the US and Canada please allow up to 6 weeks for delivery of your first magazine. In the UK and Republic of Ireland please allow six to 14 weeks for delivery of your first magazine. By signing this form you consent the LEGO Club to use your child's data for LEGO mailings. The data will only be used for LEGO mailings and will not be sold, rented or otherwise disclosed to any company outside the LEGO Company except for disclosure to companies acting as our agents to help us provide services requested by the child. This coupon is valid for one free membership per person, group or organization. Photocopied coupons are accepted. La version française du magazine peut être postée uniquement au Canada. L'abonnement est valide pour 2 ans et inclut des exemplaires gratuits du Magazine LEGO. Aux E.-U. et au Canada, allouer 6 semaines pour la livraison initiale. En remplissant ce formulaire, vous consentez à ce que LEGO utilise les informations de votre enfant pour des envois postaux de LEGO. L'information sera utilisée uniquement pour des envois postaux par LEGO et ne sera en aucun cas, vendue, louée, échangée ou divulguée à d'autres compagnies autres que la compagnie LEGO, à l'exception des compagnies affiliées qui nous procurent des services auxquels l'enfant en a fait la demande. Formulaires photocopiés acceptés. Mit der folgenden Unterschrift erkläre ich, für mein Kind den Beitritt als Mitglied zum kostenlosen LEGO Club, der von der LEGO GmbH, D-85627 Grasbrunn, betrieben wird. Die Mitgliedschaft beinhaltet die Zusendung des LEGO Club Magazins und kann beiderseits jederzeit beendet werden. Mit der Mitgliedschaft im LEGO Club sind keinerlei Verpflichtungen verbunden. Das deutschsprachige LEGO Club Magazin wird nur an Adressen in Deutschland, Österreich und der Schweiz versendet. Eine Anmeldebestätigung kann nur per E-Mail geschickt werden. Das Magazin erscheint fünfmal jährlich. Daher kann die Zustellung des ersten Heftes bis zu drei Monate dauern. Die Mitgliedschaft ist beidseitig jederzeit kündbar, ohne dass Ihnen Kosten entstehen. Sie können der werblichen Nutzung Ihrer Daten jederzeit widersprechen. Kündigung und Widerspruch können Sie telefonisch erklären (00800 / 5346 5555, Anruf gebührenfrei, Kosten für Anrufe aus dem Mobilfunknetz können abweichen) oder an die LEGO GmbH senden. Het Nederlandse LEGO Club Magazine kan alleen worden gestuurd naar adressen in Nederland. Het lidmaatschap is 2 jaar geldig en geeft recht op toezending van het gratis LEGO Club Magazine en LEGO Club e-mails. Het eerste magazine zal binnen 12 tot 14 weken toegestuurd worden. Het lidmaatschap kan op ieder moment opgezegd worden en kan na 2 jaar gratis worden verlengd, tenzij LEGO met deze activiteit stopt. Uw gegevens worden uitsluitend gebruikt voor mailings van LEGO en zullen niet worden verkocht, verhuurd of op welke wijze dan ook versprekt aan derden buiten de LEGO Groep, uitgezonderd de organisaties die namens ons optreden om de informatie te sturen waarvoor toestemming is verleend. Den norske utgaven av magasinet sendes kun til adresser i Norge. Medlemskap i klubben gjelder i 2 år og inkluderer gratisutgaver av LEGO Club Magazine. Pøregn minimum opp til seks uker leveringstid for første magasin. Ved å undertegne dette skjemaet, gir du ditt samtykke til at LEGO Club kan bruke opplysningene om barnet ditt i LEGO forsendelser. Dataene vil utelukkende bli brukt i LEGO forsendelser og vil ikke bli solgt, utleid eller på annen måte gjøres tilgjengelig for selskaper utenfor LEGO gruppen, unntatt selskaper som er våre agenter og som hjelper oss å tilby tjenestene barnet etterspør. Dette skjemaet gjelder for ett gratis medlemskap per person, gruppe eller organisasjon. Den svenska versionen av tidingen kan endast skickas till adresser i Sverige. Club-medlemskapet är giltigt i 2 år och innefattar gratis exemplar av LEGO Club Magazine. Vänligen räkna med minimum 6 veckor för leverans av din första tidning. Genom att skicka in det här formuläret godkänner du att LEGO Club använder barnets uppgifter för LEGO utskick. Uppgifterna kommer bara att användas för LEGO utskick och kommer inte att säljas, hyras ut eller vidarebefordras till något företag som inte tillhör LEGO Gruppen, med undantag av företag som agerar som vår ombud för att tillhandahålla tjänster som barnet har begärt. Den här kupongen gäller för ett gratis medlemskap per person, grupp eller organisation. En complétant ce bulletin d'adhésion, vous acceptez que LEGO Club utilise les données relatives à votre enfant pour l'envoi de courriers concernant LEGO. Ces données seront uniquement utilisées pour l'envoi d'information concernant LEGO et ne seront ni vendues, ni louées, ni utilisées par d'autres sociétés que le groupe LEGO, à l'exception des sociétés agissant pour le compte de LEGO en tant que sous-traitant de services divers. L'abonnement au LEGO Club est valable pour une période de 2 ans. Il inclut l'envoi par courrier du magazine LEGO Club et par email des newsletters. Un délai de 6 à 14 semaines est à prévoir pour la réception de votre premier magazine. Ce bulletin d'adhésion gratuit est valable pour l'inscription d'une seule personne. Les photocopies sont acceptées. ATTENTION! Le bulletin d'adhésion doit être rempli et signé par un parent ou un tuteur.

Parent's signature · Signature d'un parent ou d'un tuteur

• Unterschrift Erziehungsberechtigte/r • Handtekening ouders

• Foreldres/foresattes underskrift • Förälders /förmyndares underskrift

Date
Datum
Dato



WIN!

Go to www.LEGOsurvey.com/product
to fill out a survey for a chance
to win a cool LEGO® Product.
No purchase necessary.
Open to all residents where not prohibited.

 www.LEGO.com



www.LEGOsurvey.com/product

GEWINNE! WIN!

Nimm an der Umfrage auf
www.LEGOsurvey.com/product
teil und hab die Chance ein cooles
LEGO® Produkt zu gewinnen!

Die Teilnahme am Gewinnspiel führt zu keinerlei
Kaufverpflichtungen. Teilnahme in allen nicht
ausgeschlossenen Ländern möglich.

Ga naar www.LEGOsurvey.com/product,
vul een enquêteformulier
in en maak kans op een
cool LEGO® product.

Geen aankoopverplichting.
Iedereen mag deelnemen, uitgezonderd
ingezetenden van landen waar een
enquêteverbod geldt.

GAGNE! 当てよう!

Visite www.LEGOsurvey.com/product
pour répondre à un
questionnaire et avoir une chance de
gagner un produit LEGO® très cool!

Aucune obligation d'achat.
Ouvert à tous les résidents des pays
autorisés.

www.LEGOsurvey.com/product にアクセスして、
アンケートにご記入ください。当選者にはレゴ®
製品を差し上げます。

お買い上げの必要はありません。

禁止されていない限り、すべての皆様にご利用いただけます。