



Architecture

21035

Solomon R. Guggenheim Museum®

New York City, USA

Musée Solomon R. Guggenheim®

New York, États-Unis

Museo Solomon R. Guggenheim®

Ciudad de Nueva York (EE. UU.)



[LEGO.com/architecture/booklet](https://www.lego.com/architecture/booklet)

Solomon R. Guggenheim Museum



Widely regarded as an exceptional icon of the 20th century, the Solomon R. Guggenheim Museum launched the great age of museum architecture and proved that a collection's physical home could be as crucial a part of the museum experience as the work itself.



The Story of an Iconic Building

In June 1943, Frank Lloyd Wright was asked by Hilla Rebay, the art advisor to Solomon R. Guggenheim, to design a new building to house Guggenheim's four-year-old Museum of Non-Objective Painting.

The project would evolve into a complex struggle pitting the architect against his clients, city officials, the art world and public opinion. It would take over 15 years, 700 sketches and seven complete sets of working drawings before Wright's vision would be realized and the Solomon R. Guggenheim Museum would open its doors for the first time in 1959. By then both Guggenheim and Wright had died.

The location of the Guggenheim Museum on Fifth Avenue between 88th and 89th Streets is not accidental. Its proximity to Central Park was key; as close to nature as one can get in New York, the park affords relief from the noise and congestion of the city.

Nature not only provided the museum with a respite from New York's distractions, but also lent it inspiration. The Guggenheim Museum is an embodiment of Frank Lloyd Wright's attempts to utilize organic forms in architecture.

But even as it embraced nature, Wright's design also expresses his unique take on modernist architecture's rigid geometry. The building is a symphony of triangles, ovals, arcs, circles and squares.

Wright dispensed with the conventional approach to museum design, which led visitors through a series of interconnected rooms. Instead, he whisked people to the top of the building via elevator and led them downward at a leisurely pace on the gentle slope of a continuous ramp. The open rotunda afforded viewers the unique possibility of seeing several bays of work on different levels simultaneously.

The building itself has often been called the most important piece of art in the Guggenheim collection.

*["An idea is salvation
by imagination"]*

Frank Lloyd Wright



THE SOLOMON R. GUGGENHEIM M U



The Story Continues

When the museum opened to an enthusiastic public on October 21, 1959, just six months after Frank Lloyd Wright's death, the relationship between the breathtaking architecture of the building and the art it was built to display inspired both controversy and debate. One critic wrote that the museum "turned out to be the most beautiful building in America... never for a minute dominating the pictures being shown," while another insisted that the structure was "less a museum than a monument to Frank Lloyd Wright."

Wright had originally suggested the construction of a tall building behind the museum itself to house its administration and provide the perfect backdrop to his structure, but it would be 1992 before this was finally achieved.

Today the Guggenheim collection has grown substantially and is now shared with other sister museums around the world. The New York museum, however, remains the spiritual home of the collection and receives over one million visitors every year.





About the Architect

Arguably America's greatest architect and among the world's most gifted, Frank Lloyd Wright was also a man of boundless energy. In a career that spanned over 74 years, he designed more than 900 works – including houses, offices, churches, schools, libraries, bridges, museums and many other building types. Of that total, over 500 resulted in completed works. Today, over 400 of these buildings still remain.

Wright's creative mind was not only confined to architecture. He also designed furniture, fabrics, art glass, lamps, dinnerware, silver, linens and graphic arts. In addition, he was a prolific writer, an educator and a philosopher. He authored twenty books and countless articles and lectured throughout the United States, as well as in Europe.

Wright was born in 1867 in the rural farming town of Richland Center, Wisconsin, just two years after the American Civil War ended, and passed away at the age of 91 in 1959. While there is evidence of Wright attending both high school and the University of Wisconsin-Madison, there is no record of him graduating from either. In 1887 Wright moved to Chicago and by the early 1890s he was already head draftsman at the architectural firm of Adler & Sullivan.

Wright was recognized as a brilliant architect by his peers and continues to be revered today. No other architecture took greater advantage of setting and environment. No other architect glorified the sense of "shelter" as did Frank Lloyd Wright. As he famously stated: "A building is not just a place to be. It is a way to be."



Facts

Architect: Frank Lloyd Wright
Classification: Art Museum
Location: New York City, New York, USA
Architectural Style: Modern Movement
Height: 92 ft. (28 m)
Materials: Aluminum, Steel, Concrete
and Glass
Year: 1943-1959

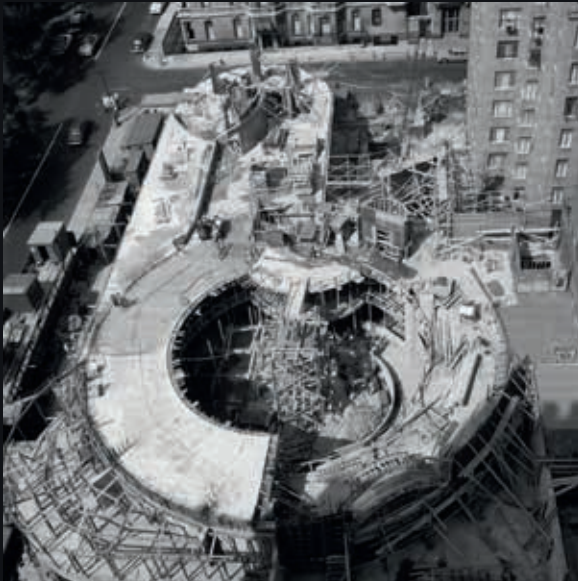

©The Solomon R. Guggenheim Foundation, New York



©The Solomon R. Guggenheim Foundation, New York



Musée Solomon R. Guggenheim



Largement reconnu comme une icône exceptionnelle du 20^e siècle, le musée Solomon R. Guggenheim lança la grande époque de l'architecture des musées et a prouvé que l'emplacement physique d'une collection pouvait être un aspect aussi crucial de la visite d'un musée que les œuvres elles-mêmes.



L'histoire d'un bâtiment emblématique

En juin 1943, Hilla Rebay, la conseillère artistique de Solomon R. Guggenheim, chargea Frank Lloyd Wright de créer un nouveau bâtiment pour abriter le musée de la peinture non figurative de Guggenheim, datant de quatre ans.

Ce projet allait se transformer en lutte complexe entre l'architecte et ses clients, l'administration de la ville, le monde de l'art et l'opinion publique. Il a fallu plus de 15 ans, 700 esquisses et sept ensembles complets de dessins de travail pour que la vision de Wright soit réalisée, et le musée Solomon R. Guggenheim fut finalement inauguré en 1959. Guggenheim et Wright étaient alors déjà morts tous les deux.

L'emplacement du musée Guggenheim, sur la Cinquième avenue, entre la 88^e et la 89^e rue, n'est pas dû au hasard. Sa proximité avec Central Park était essentielle. Aussi proche de la nature que possible à New York, ce parc permet de s'éloigner du bruit et de la congestion de la ville.

La nature fournit non seulement au musée une accalmie dans l'agitation de New York, mais elle a aussi été une inspiration pour sa création. Le musée Guggenheim incarne les tentatives de Frank Lloyd Wright d'utiliser des formes organiques dans l'architecture.

Mais tout en s'inspirant de la nature, le design de Wright exprime aussi sa vision unique de la géométrie rigide de l'architecture moderniste. Le bâtiment est une symphonie de triangles, d'ovales, d'arches, de cercles et de carrés.

Wright a abandonné l'approche conventionnelle de la création de musée, qui faisait passer les visiteurs par une série de salles interconnectées. Il les fit plutôt monter par un ascenseur jusqu'au sommet du bâtiment pour les faire ensuite descendre lentement sur la pente douce d'une rampe continue. La rotonde ouverte offrait aux visiteurs la possibilité unique de voir simultanément plusieurs salles d'œuvres à différents niveaux.

Ce bâtiment emblématique a souvent été appelé l'œuvre d'art la plus importante de la collection du Guggenheim.

*[« Une idée est le salut
par l'imagination »]*

Frank Lloyd Wright



THE SOLOMON R. GUGGENHEIM M U

L'histoire se poursuit...

Lorsque le musée fut inauguré avec un public enthousiaste le 21 octobre 1959, juste six mois après la mort de Frank Lloyd Wright, la relation entre l'architecture spectaculaire du bâtiment et les œuvres d'art pour lesquelles il avait été construit a suscité débats et controverses. Un critique a écrit que le musée « s'est révélé être le plus beau bâtiment en Amérique... ne dominant jamais les tableaux exposés », tandis qu'un autre souligna qu'il s'agissait « moins d'un musée que d'un monument à Frank Lloyd Wright ».

Wright avait à l'origine suggéré la construction d'un bâtiment élevé, derrière le musée lui-même, pour abriter l'administration et fournir l'arrière-plan idéal pour sa structure. Il ne fut finalement achevé qu'en 1992.

La collection du Guggenheim s'est aujourd'hui agrandie de façon substantielle et est maintenant partagée avec des musées jumelés dans le monde entier. Le musée de New York reste cependant l'incarnation spirituelle de la collection et accueille plus d'un million de visiteurs chaque année.





À propos de l'architecte

Sans doute le plus grand architecte américain et l'un des plus doués au monde, Frank Lloyd Wright était aussi un homme à l'énergie illimitée. Dans une carrière qui a duré plus de 74 ans, il a conçu plus de 900 œuvres, notamment des maisons, des bureaux, des églises, des écoles, des bibliothèques, des ponts, des musées et de nombreux autres types de bâtiments. Sur ce total, plus de 500 ont été construits. Plus de 400 de ces constructions demeurent aujourd'hui.

L'esprit créatif de Wright ne se limitait pas à l'architecture. Il créa aussi des meubles, des tissus, des objets en verre, des lampes, de la vaisselle, de l'argenterie, du linge et des réalisations graphiques. Il était aussi un écrivain prolifique, un pédagogue et un philosophe. Il écrivit vingt livres et d'innombrables articles et fit des conférences dans tous les États-Unis et en Europe.

Wright est né en 1867, dans la ville agricole de Richland Center, au Wisconsin, seulement deux ans après la guerre civile américaine. Il mourut en 1959 à l'âge de 91 ans. Wright a suivi les cours de l'école secondaire et de l'Université de Wisconsin-Madison, mais il n'y a aucune preuve qu'il ait été diplômé par l'une ou l'autre. En 1887, Wright s'installa à Chicago, et dès le début des années 1890, il était déjà dessinateur en chef dans le cabinet d'architecture Adler & Sullivan.

Wright était reconnu comme un architecte brillant par ses pairs et continue d'être révééré aujourd'hui. Aucune autre architecture n'a plus tiré parti du cadre et de l'environnement. Aucun autre architecte n'a glorifié le sens « d'abri » comme l'a fait Frank Lloyd Wright. Selon sa célèbre déclaration : « Un bâtiment n'est pas seulement un endroit où être. C'est une façon d'être. »



Informations

Architecte : Frank Lloyd Wright
Classification : Musée d'art
Lieu : Ville de New York, New York, États-Unis
Style architectural : Mouvement moderne
Hauteur : 28 m
Matériaux : Aluminium, acier, béton et verre
Années : 1943-1959

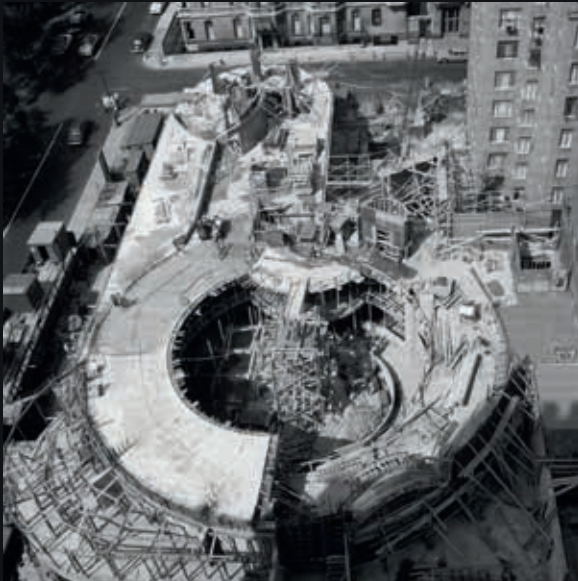

©The Solomon R. Guggenheim Foundation, New York



©The Solomon R. Guggenheim Foundation, New York



Museo Solomon R. Guggenheim



Ampliamente considerado un extraordinario icono del siglo XX, el Museo Solomon R. Guggenheim dio paso a la era dorada de la arquitectura museística y demostró que el hogar físico de una colección puede ser una parte tan fundamental de la exposición como las propias obras de arte.



La historia de un edificio emblemático

En junio de 1943, Hilla Rebay, asesora de arte de Solomon R. Guggenheim, encargó a Frank Lloyd Wright el diseño de un nuevo edificio para albergar la colección de pintura no objetiva del Museo Guggenheim, nacida cuatro años antes.

El proyecto evolucionaría hasta convertirse en una compleja lucha que enfrentó al arquitecto contra sus clientes, las autoridades de la ciudad, el mundo del arte y la opinión pública. Hicieron falta más de 15 años, 700 borradores y siete juegos de planos completos para hacer realidad la visión de Wright y que el Museo Solomon R. Guggenheim pudiera abrir sus puertas por primera vez en 1959. Para entonces, tanto Guggenheim como Wright habían fallecido.

La ubicación del Museo Solomon R. Guggenheim en la Quinta Avenida, entre las calles 88 y 89, no es accidental. La proximidad a Central Park era fundamental; lo más parecido a un espacio natural que hay en Nueva York, el parque permite aislarse del ruido y la congestión urbana.

La naturaleza no sólo daba al museo un respiro frente a las distracciones de Nueva York, sino que servía también como inspiración. El Museo Solomon R. Guggenheim encarna los intentos de Frank Lloyd Wright de incorporar las formas orgánicas a la arquitectura.

Sin embargo, al tiempo que abraza la naturaleza, el diseño de Wright expresa también su exclusivo punto de vista sobre la rígida geometría de la arquitectura modernista. El edificio es una sinfonía de triángulos, óvalos, arcos, círculos y cuadrados.

Wright prescindió del modelo tradicional de museo, que conduce a los visitantes a través de una serie de salas interconectadas. En su lugar, decidió llevar a la gente a la última planta del edificio con un elevador y conducirlos relajadamente hacia abajo por la suave pendiente de una rampa continua. La rotonda abierta permite al espectador contemplar simultáneamente diferentes obras de arte a distintos niveles.

El propio edificio ha sido considerado en ocasiones la obra más importante de toda la colección Guggenheim.

[«Una idea es una reivindicación de la imaginación»]

Frank Lloyd Wright



THE SOLOMON R. GUGGENHEIM M U

La historia continúa

Cuando el museo abrió sus puertas a un público entusiasmado el 21 de octubre de 1959, sólo seis meses después de la muerte de Frank Lloyd Wright, la relación entre la sobrecogedora arquitectura del edificio y el arte que estaba destinado a contener dio lugar a grandes polémicas y debates. Mientras un crítico escribía que el museo «había resultado ser el edificio más hermoso de América [...] sin dominar ni por un instante las obras expuestas», otro insistía en que la estructura no era «tanto un museo como un monumento a Frank Lloyd Wright».

En un principio, Wright sugirió la construcción de un edificio de gran altura tras el museo para albergar su administración y servir como telón de fondo perfecto para la estructura, pero habría que esperar hasta 1992 para que sucediese tal cosa.

Hoy, la colección Guggenheim ha crecido notablemente y se expone en seis museos hermanos repartidos por todo el mundo. El de Nueva York, no obstante, sigue siendo el hogar espiritual de la colección y recibe más de un millón de visitas al año.





Acerca del arquitecto

El que muchos consideran el arquitecto más grande de América fue sin duda uno de los más inteligentes del mundo y también un hombre que desbordaba energía. A lo largo de su carrera, de 74 años de duración, diseñó más de 900 edificios. Casas, oficinas, iglesias, escuelas, bibliotecas, puentes y museos componen, junto a construcciones de otros muchos tipos, su obra. De todos los diseños que ideó, más de 500 llegaron a convertirse en obras terminadas. Hoy, más de 400 de los edificios resultantes aún permanecen en pie.

La mente creativa de Wright no se limitó a la arquitectura. También diseñó muebles, tejidos, vidrieras, lámparas, vajillas, artículos de plata, ropa de cama e incluso obras gráficas. Además, fue un prolífico escritor, educador y filósofo. Escribió veinte libros e incontables artículos, y ofreció conferencias por todo Estados Unidos y Europa.

Wright nació en Richland Center, un pueblo de agricultores de Wisconsin, en 1867 (tan sólo dos años después de que finalizara la Guerra Civil Americana), y falleció en 1959, a los 91 años. Aunque existen pruebas que demuestran que Wright asistió al instituto y recibió educación en la Universidad de Wisconsin-Madison, no parece que se graduase en ninguno de ambos casos. En 1887, Wright se mudó a Chicago y a principios de la década de 1890 ya era delineante jefe en el estudio de arquitectura Adler & Sullivan.

Sus compañeros reconocieron en Wright a un arquitecto brillante que todavía hoy es reverenciado. Ningún otro estilo arquitectónico ha conseguido sacar tanto partido del contexto y el entorno. Ningún otro arquitecto ha logrado glorificar la sensación de « refugio » como Frank Lloyd Wright. Tal y como él mismo dijo: « Un edificio no es sólo un lugar para estar. Es un lugar para ser ».



Datos

Arquitecto: Frank Lloyd Wright
Categoría: Museo de arte
Situación: Ciudad de Nueva York, Nueva York (EE. UU.)
Estilo arquitectónico: Movimiento moderno
Altura: 28 m
Materiales: Aluminio, acero, concreto y vidrio
Período de construcción: 1943-1959

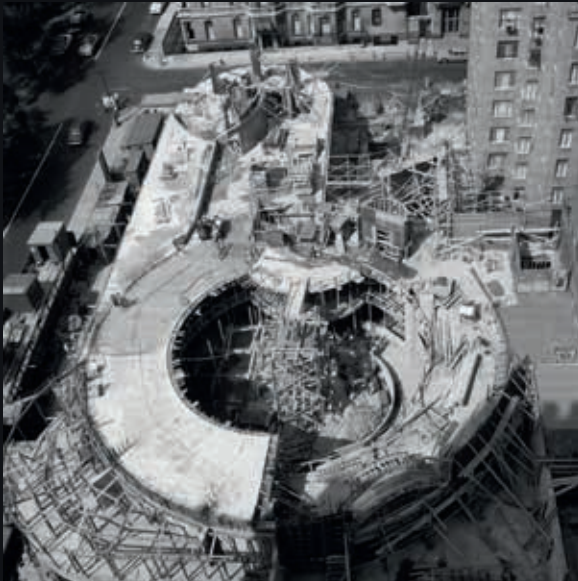

© The Solomon R. Guggenheim Foundation (Nueva York)



© The Solomon R. Guggenheim Foundation (Nueva York)



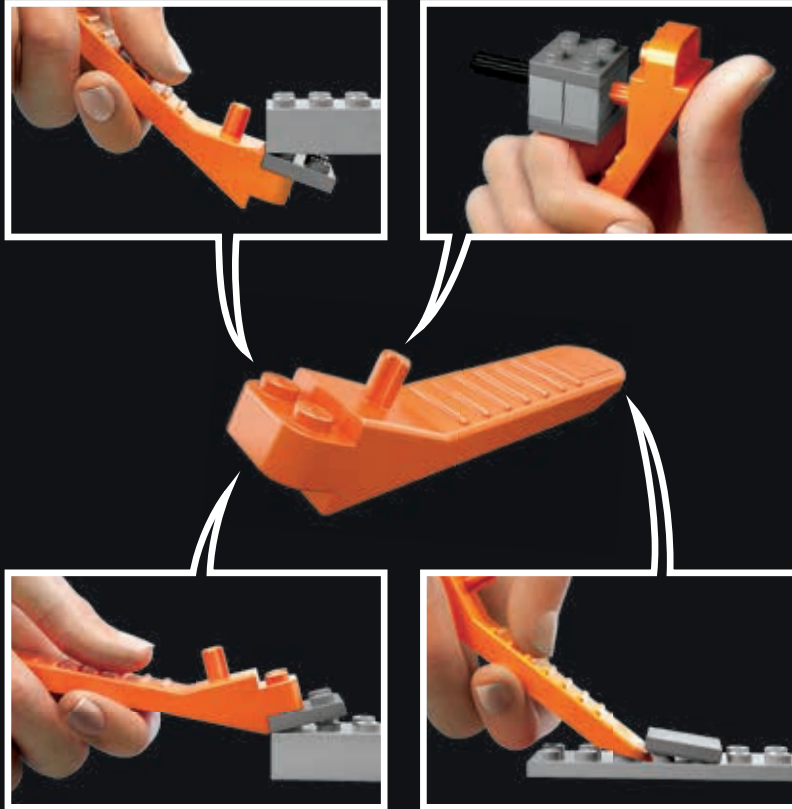

LEGO.com/brickseparator

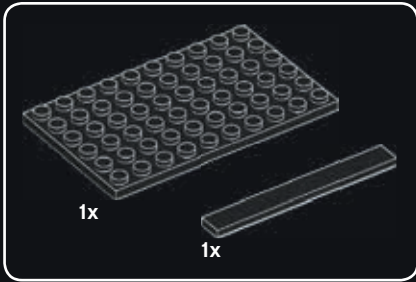
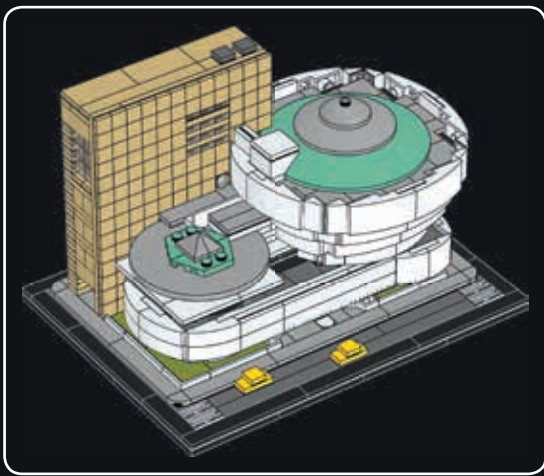

1

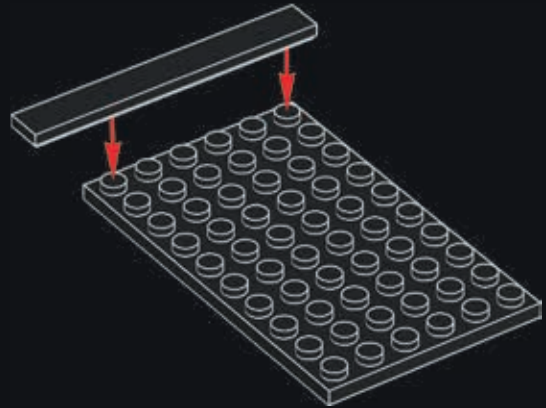

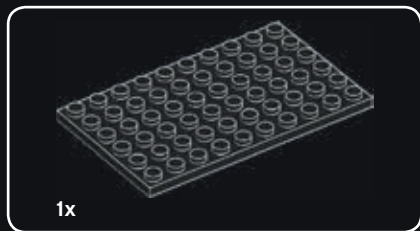

2

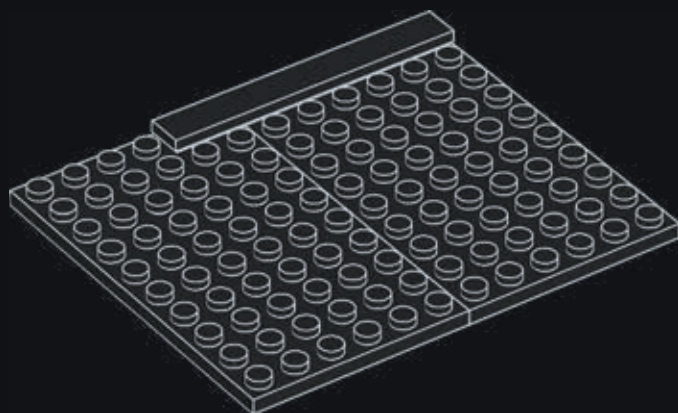



3

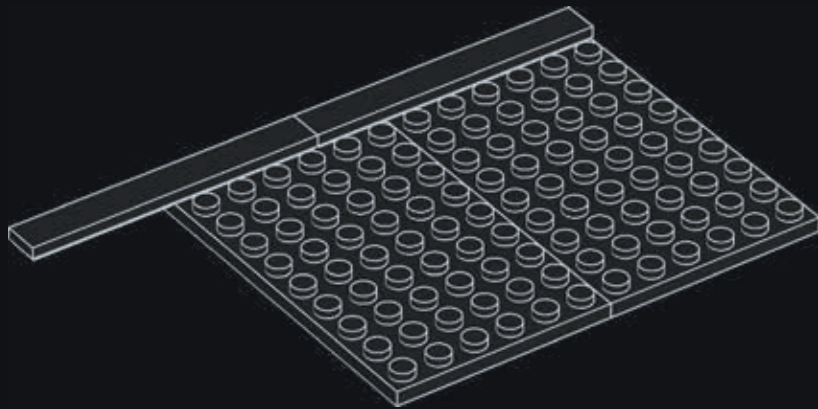

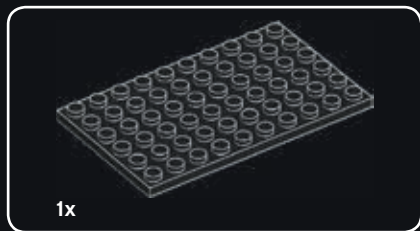

4

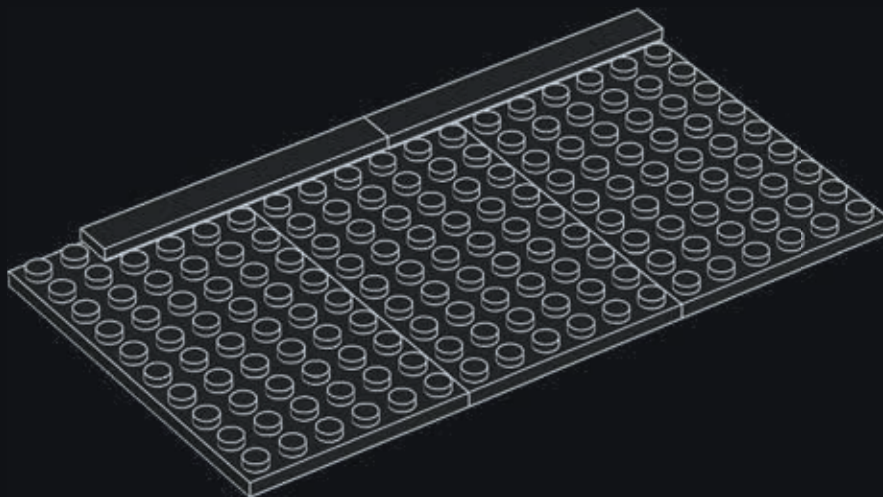



5

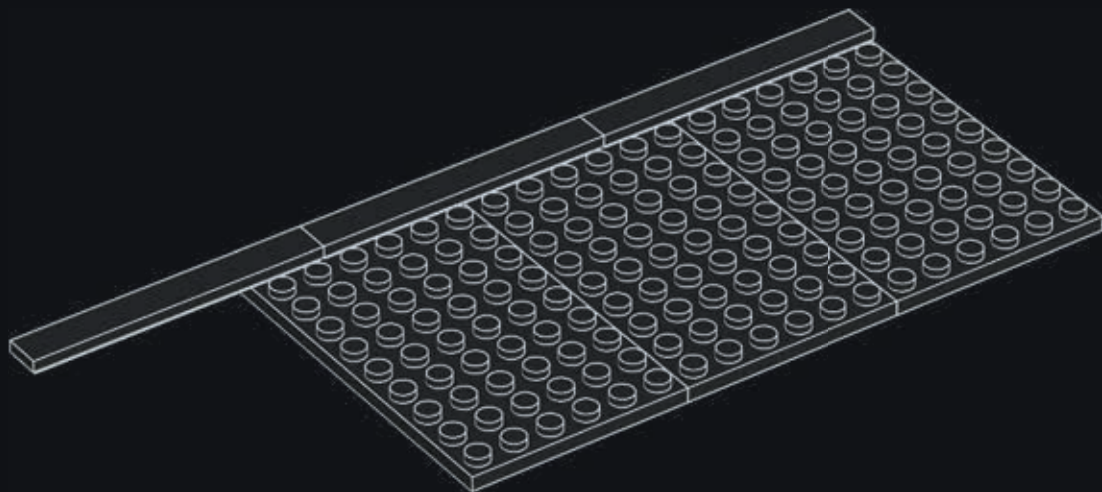

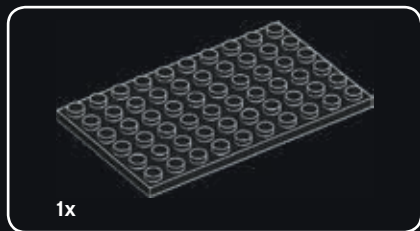

6

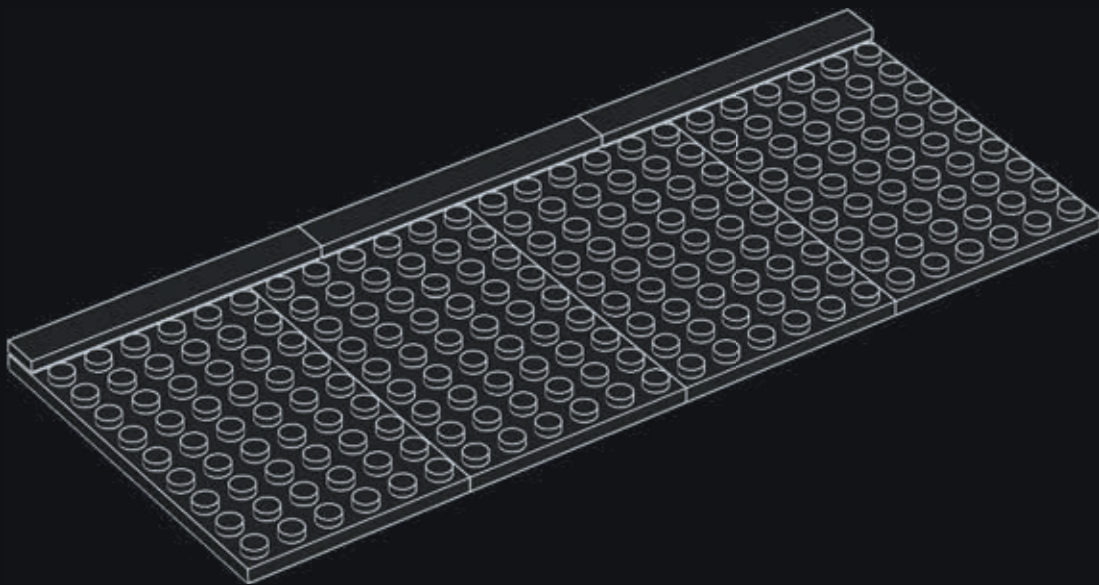

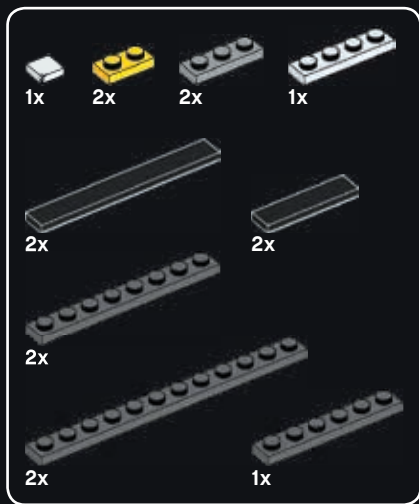

7

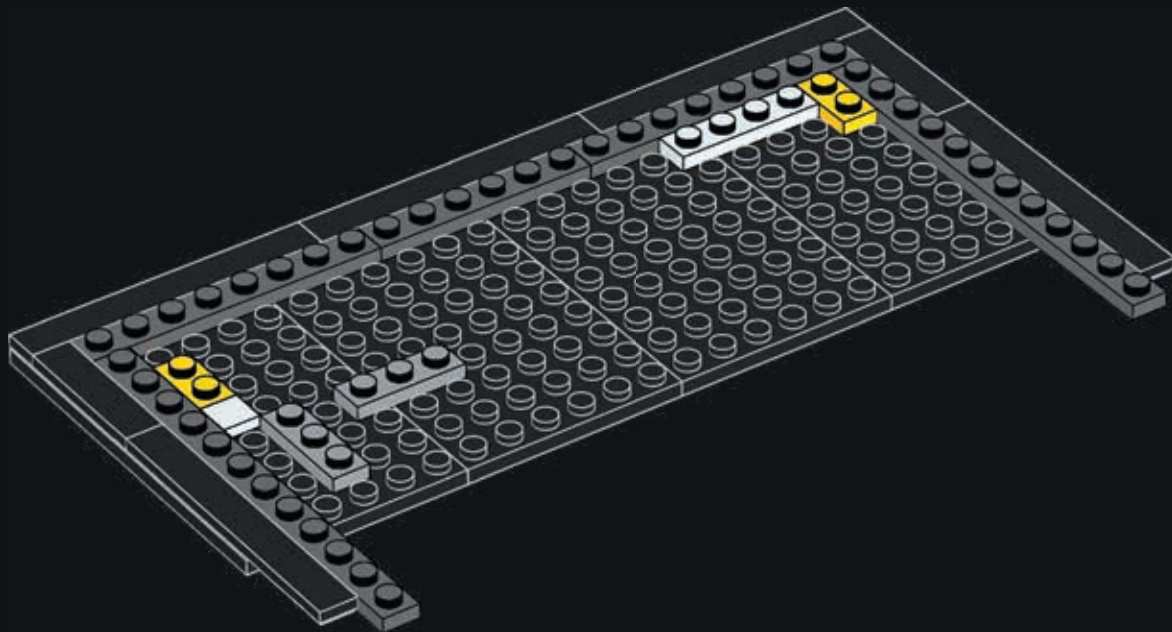

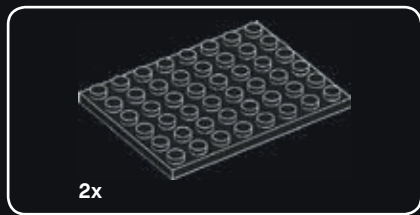

8

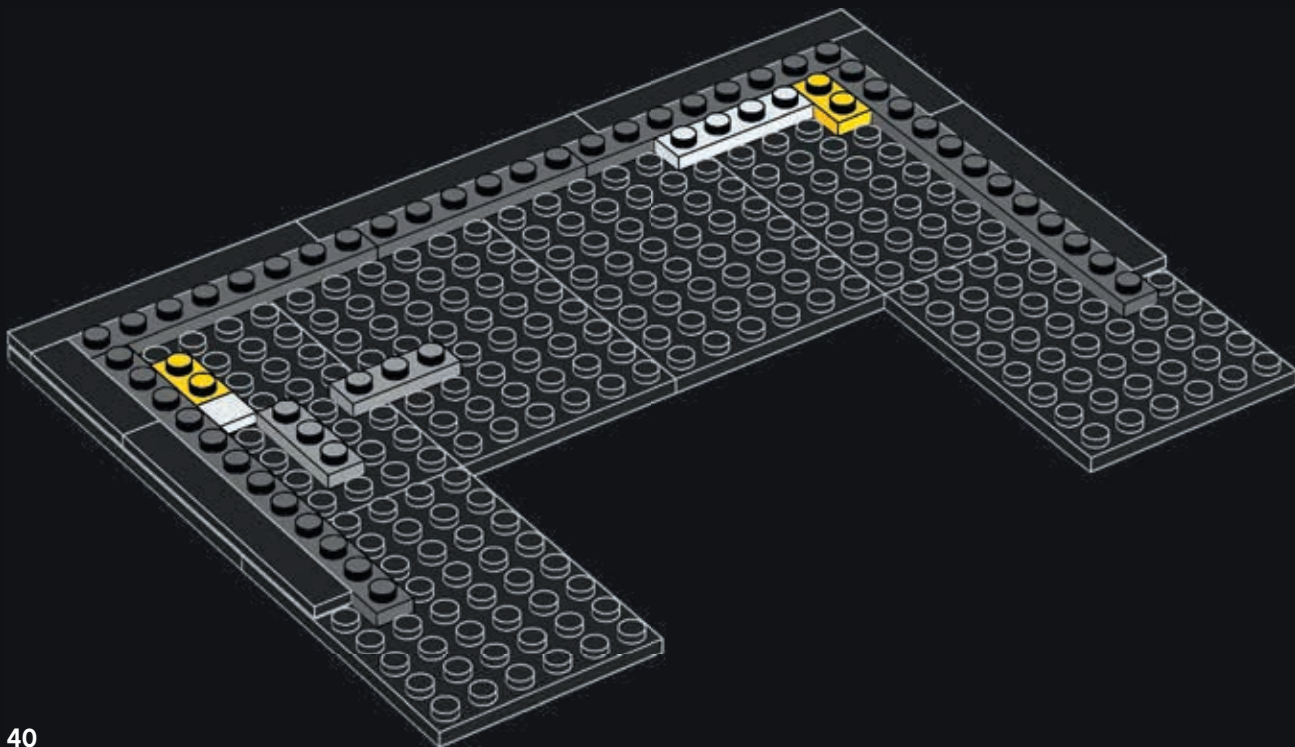

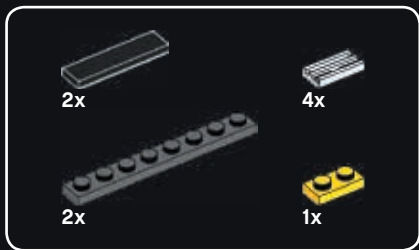

9

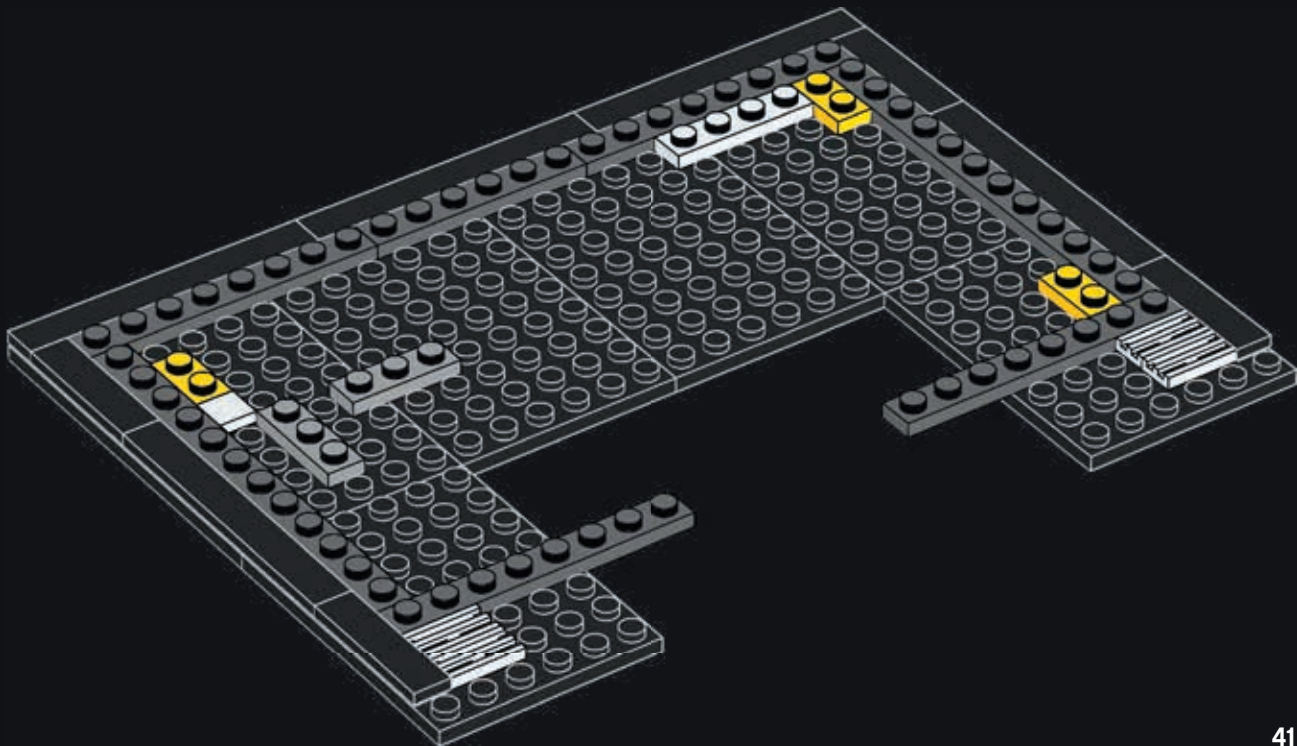

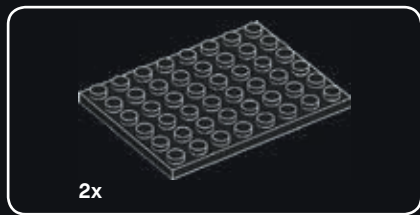

10

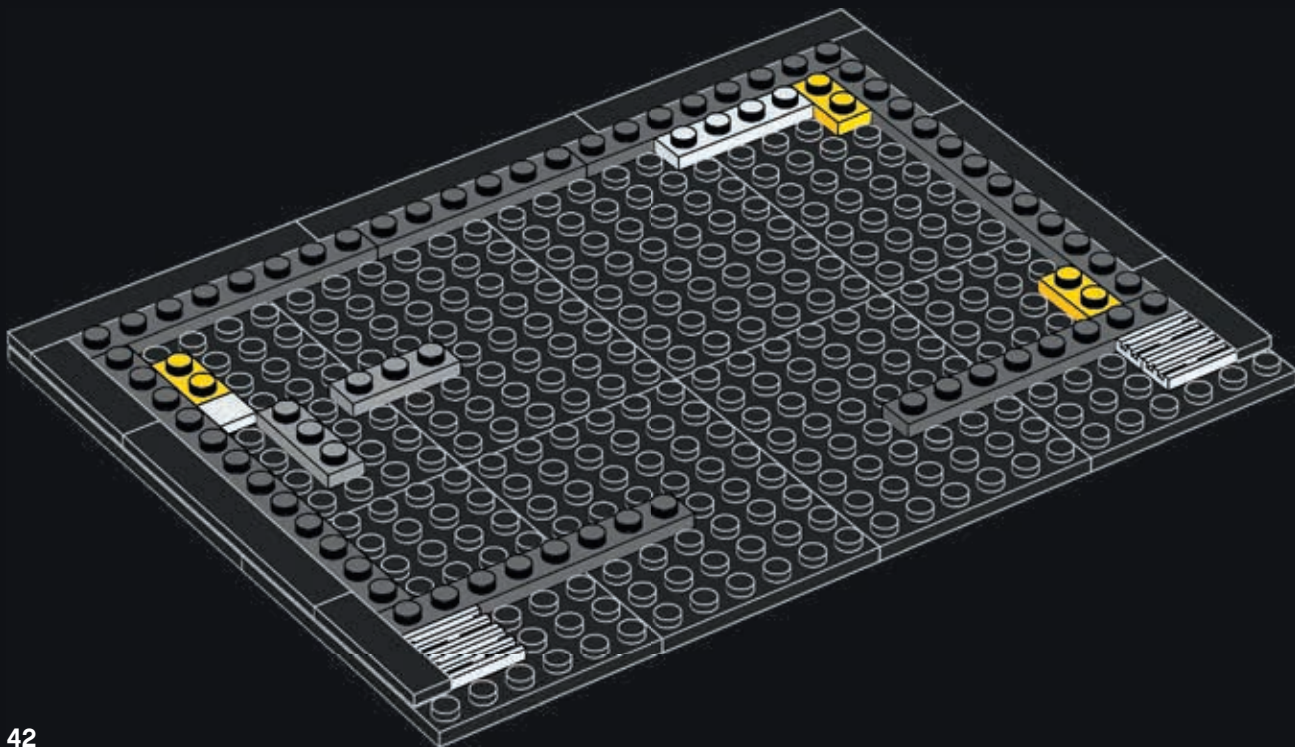

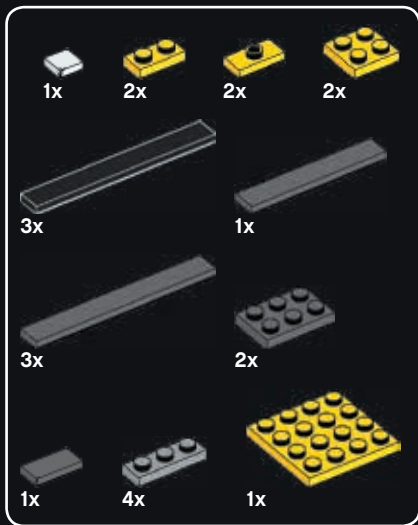

11

Frank Lloyd Wright insisted on designing every detail in the Guggenheim Museum, right down to the chairs and elevators.

Frank Lloyd Wright a insisté pour créer le moindre détail du musée Guggenheim, jusqu'aux chaises et aux ascenseurs.

Frank Lloyd Wright insistió en diseñar todos los detalles del Museo Solomon R. Guggenheim, incluidas las sillas y los elevadores.

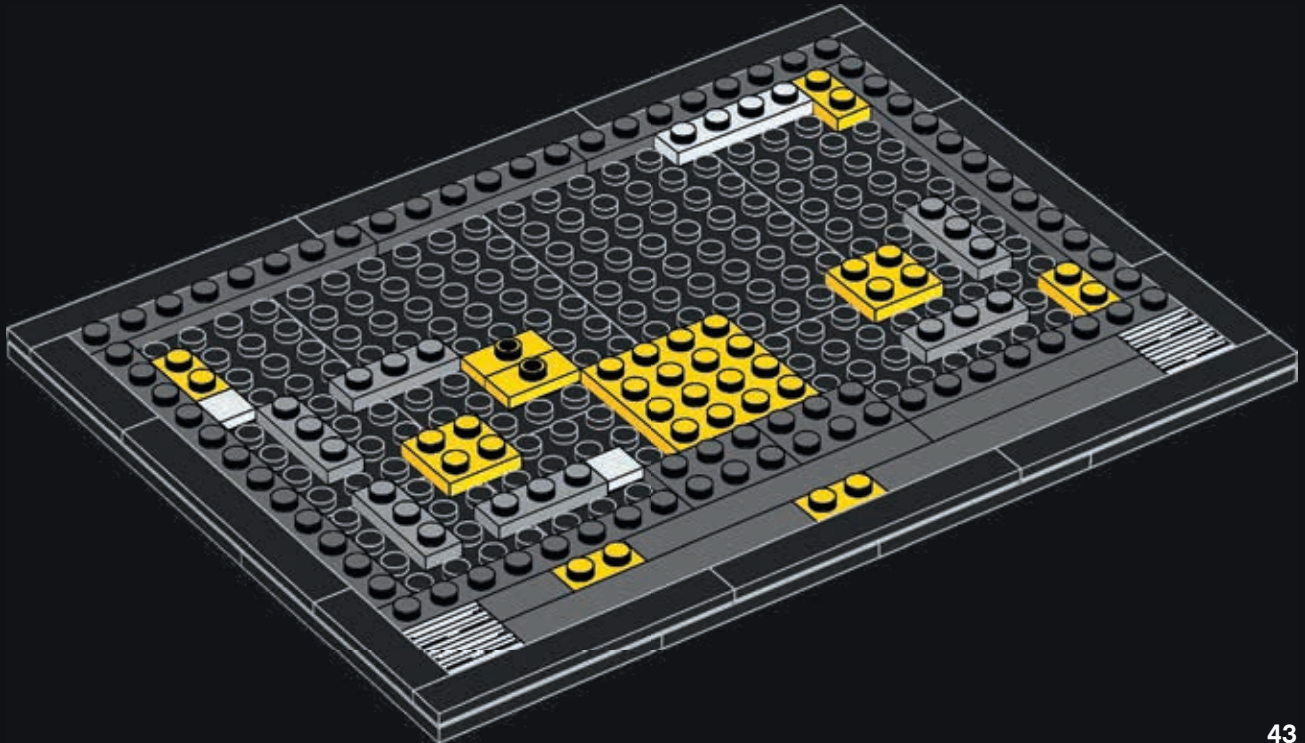

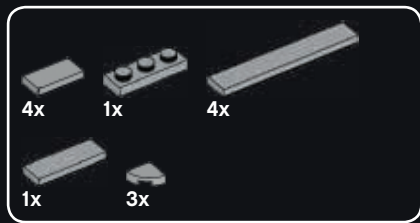

12

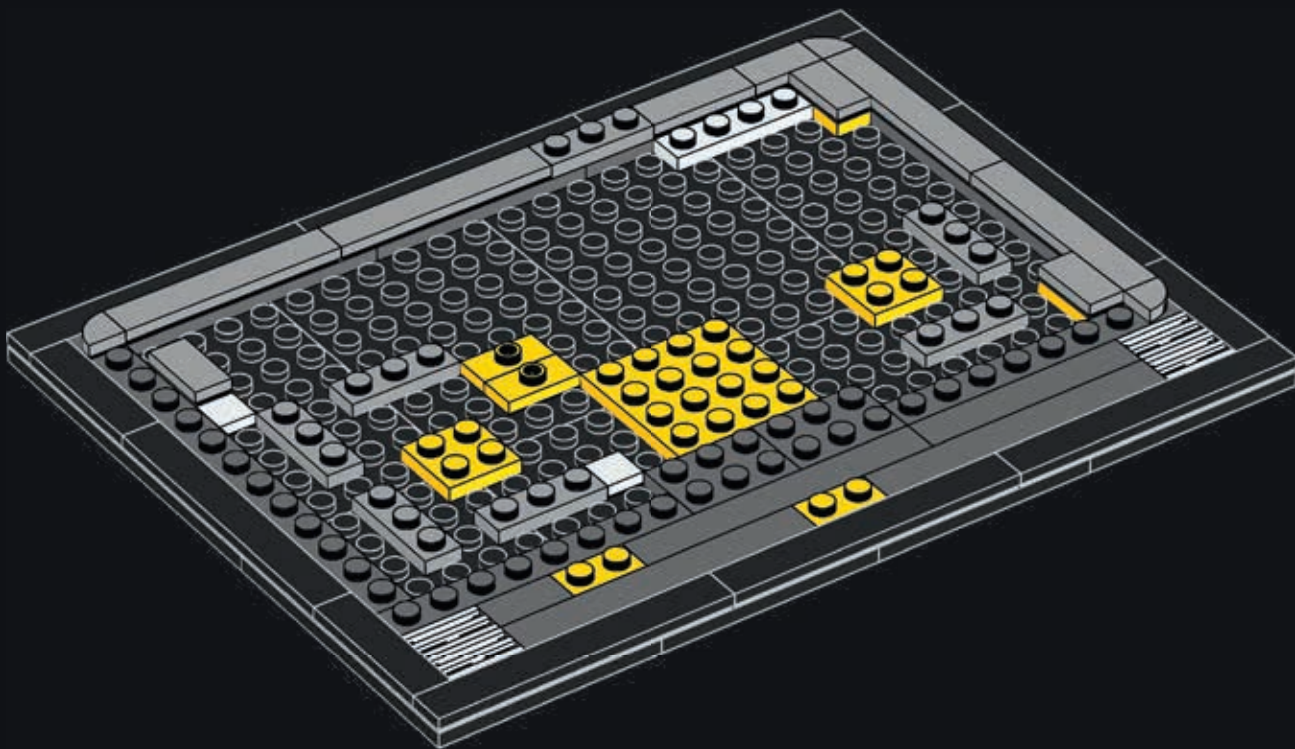



2x

14

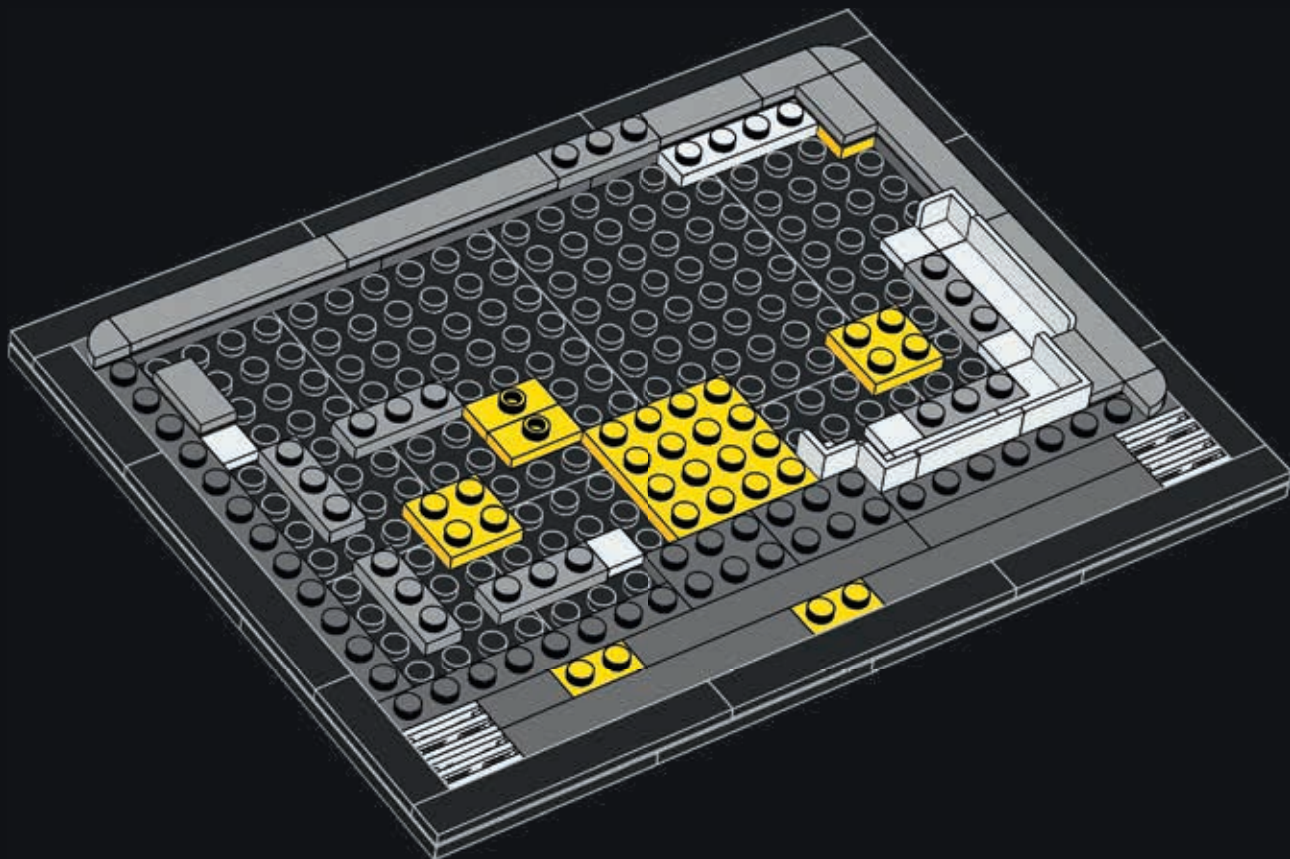



4x

15

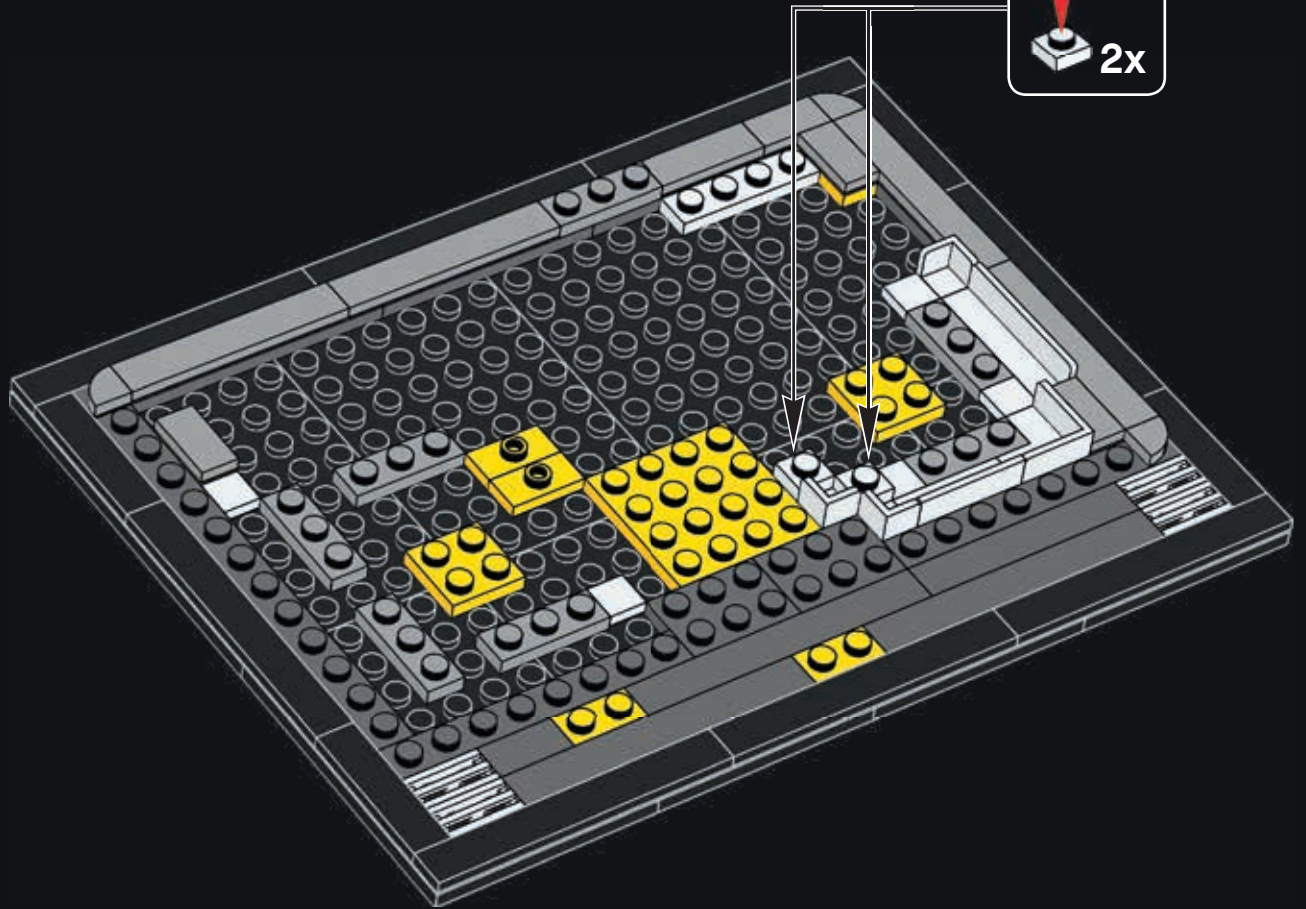



16

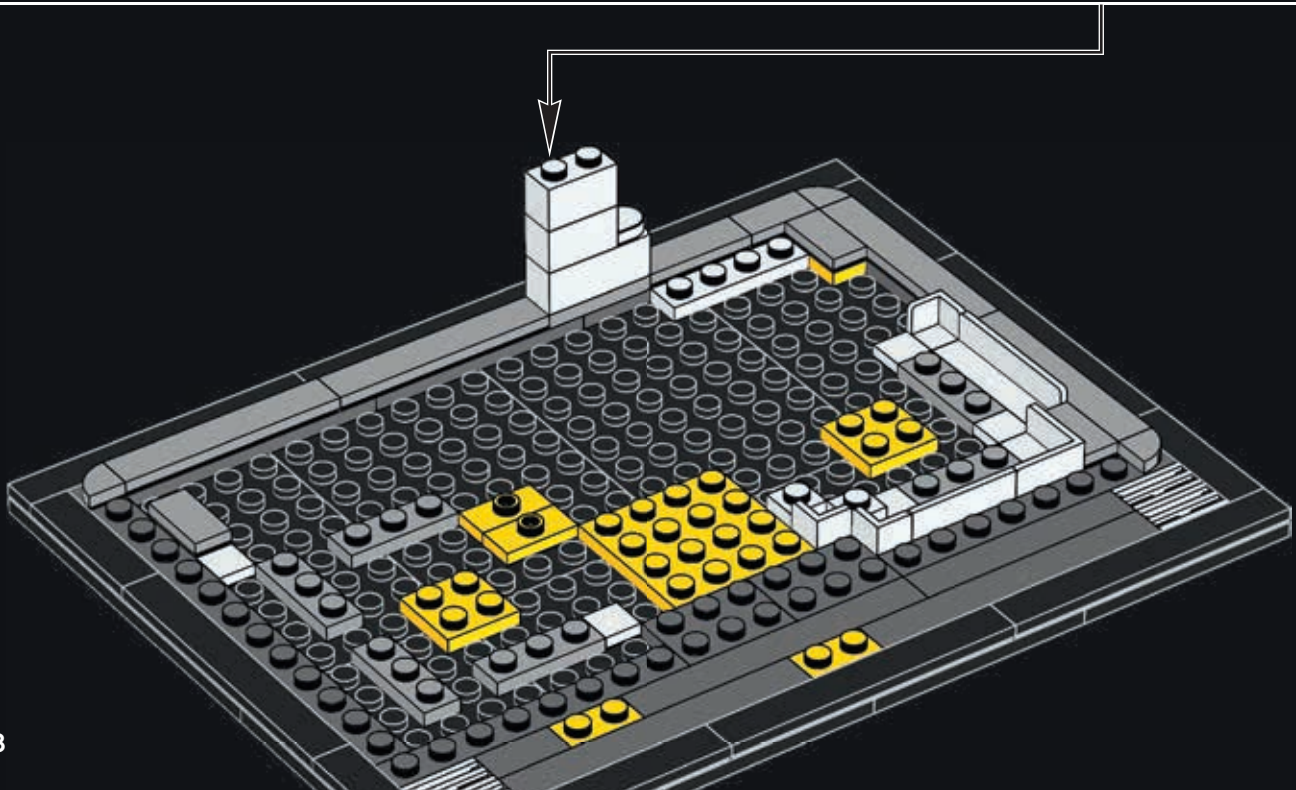

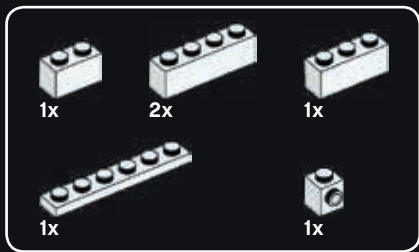

17

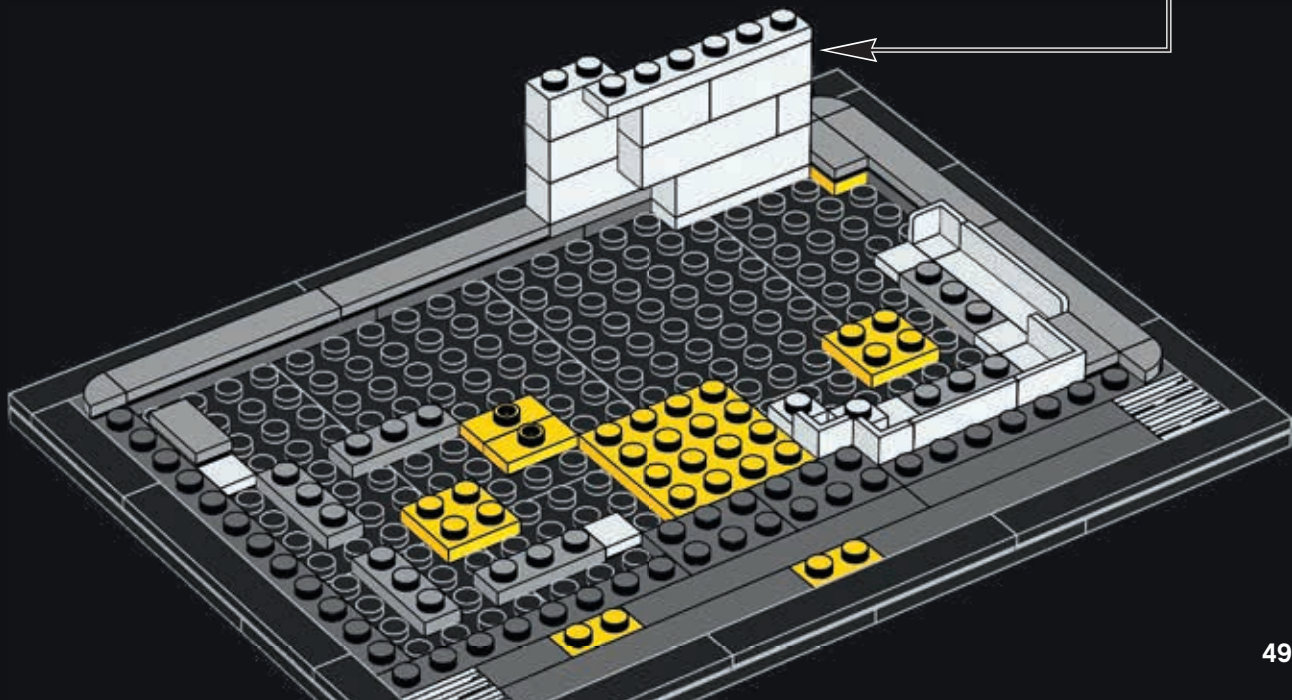
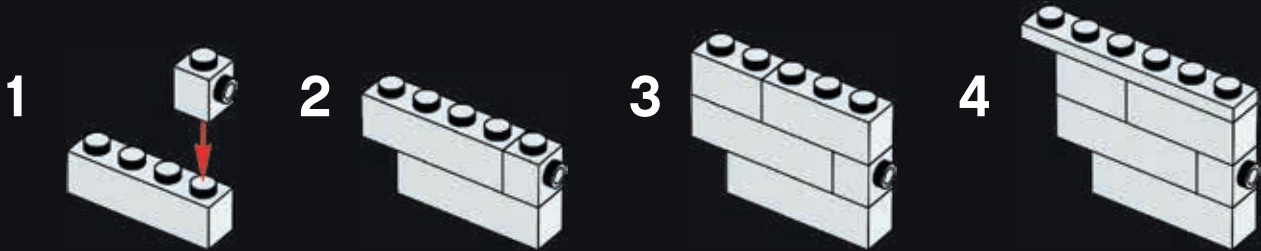



18

1



2



3



4



5

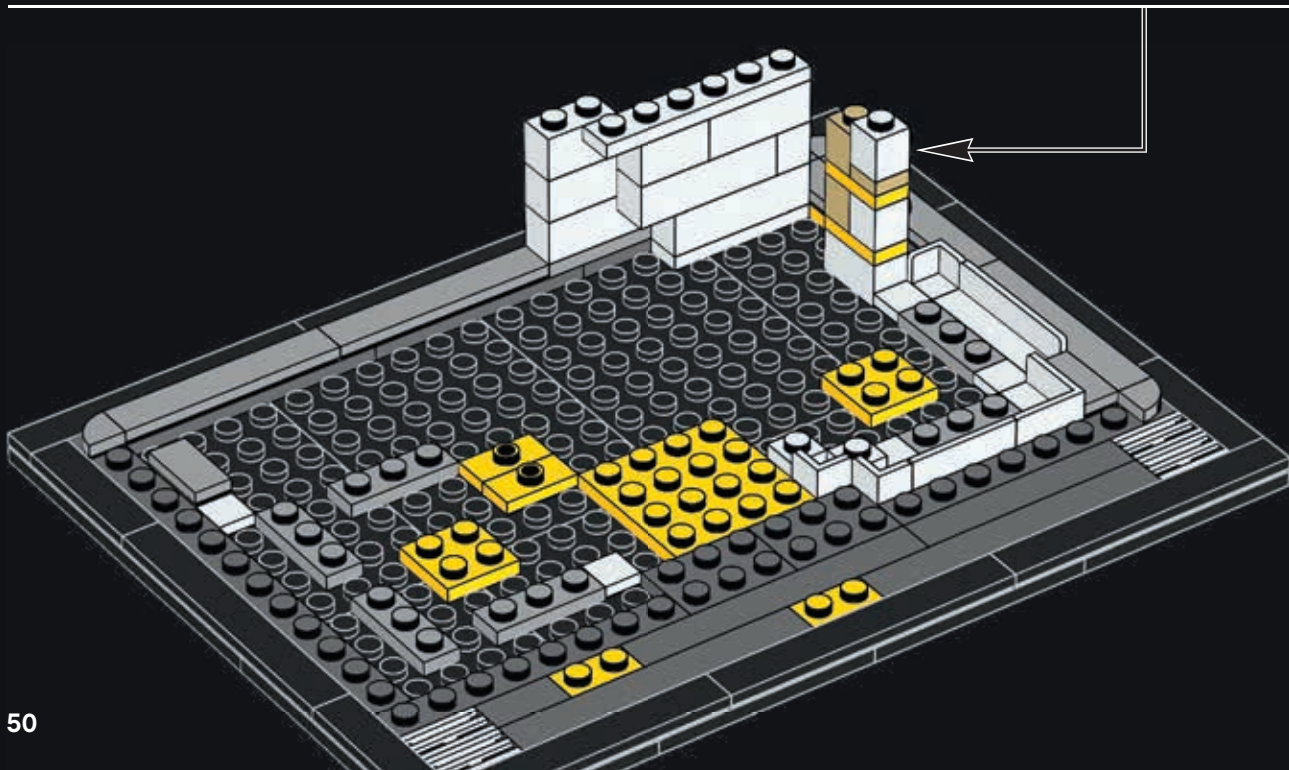



19

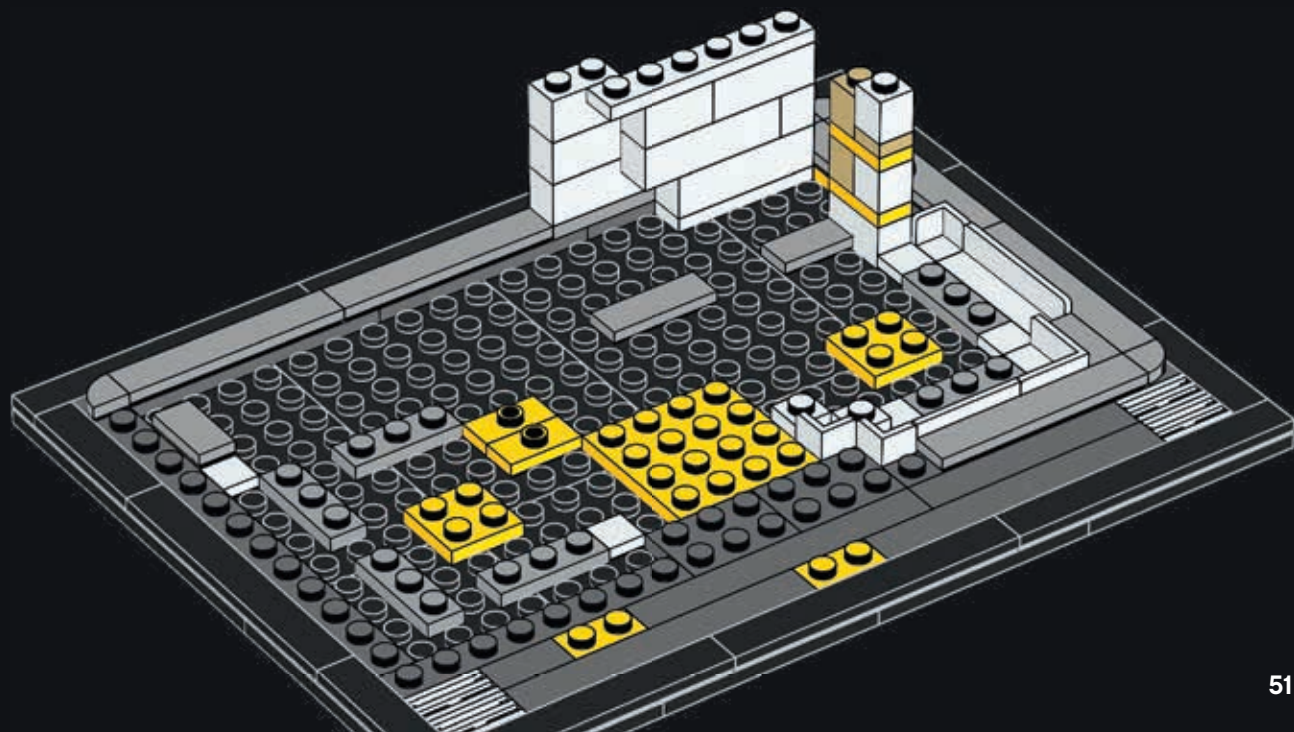

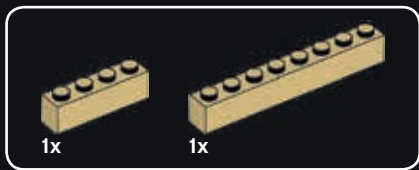

21

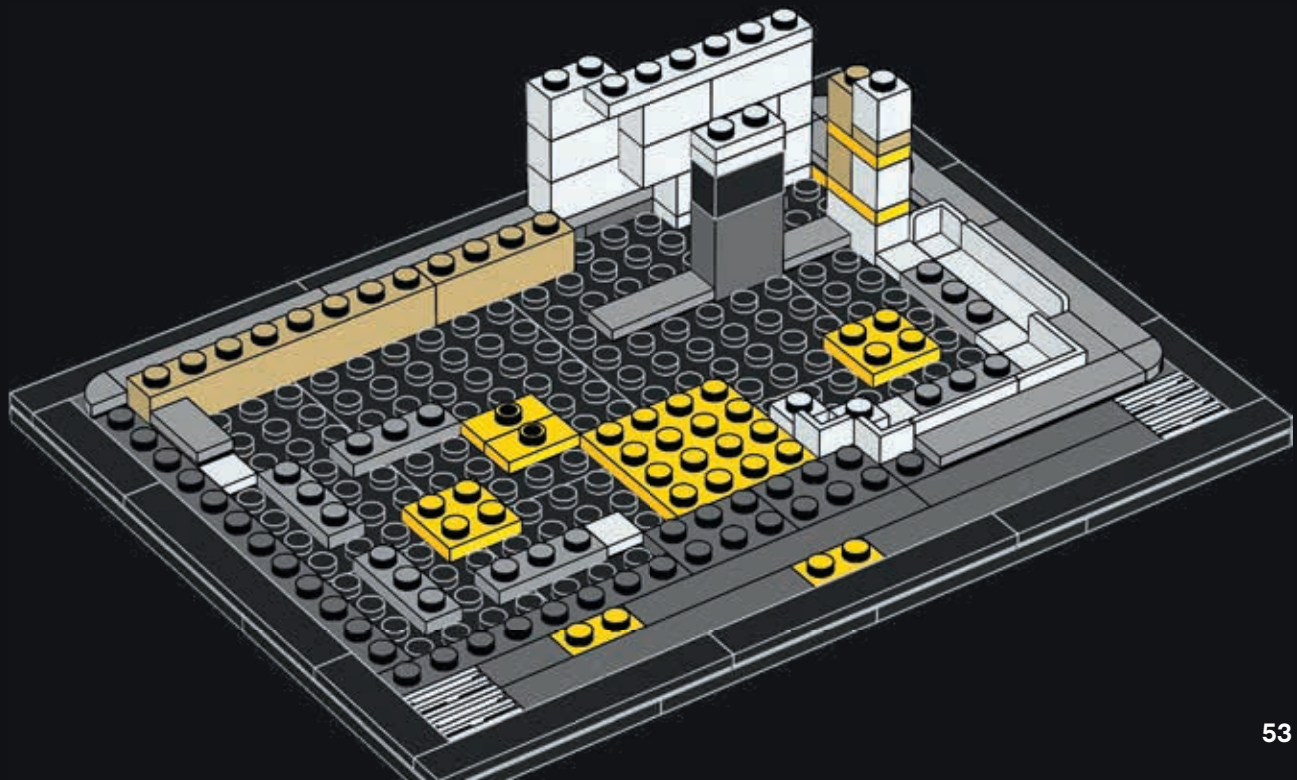

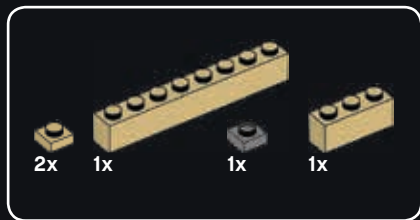

22

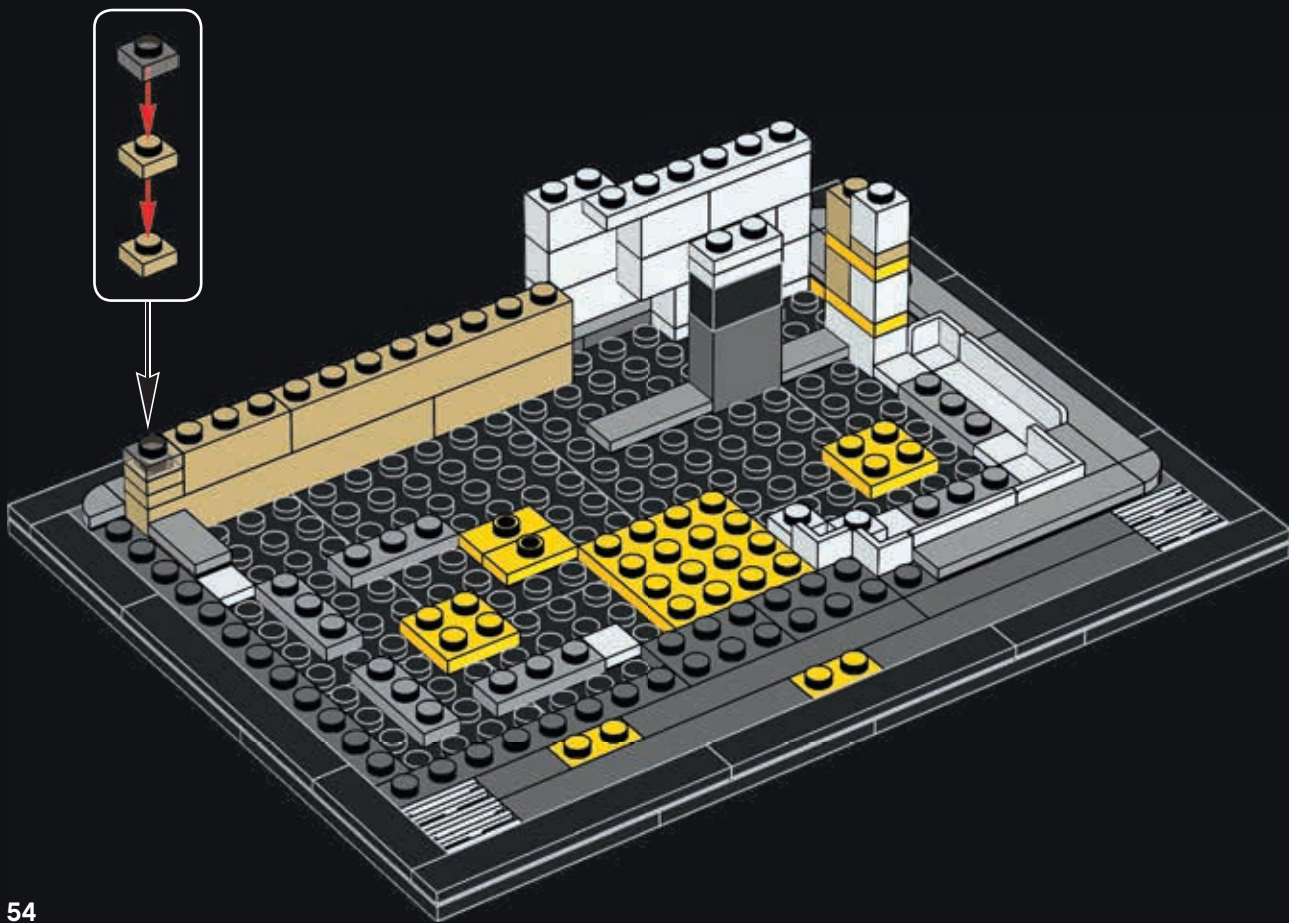



24

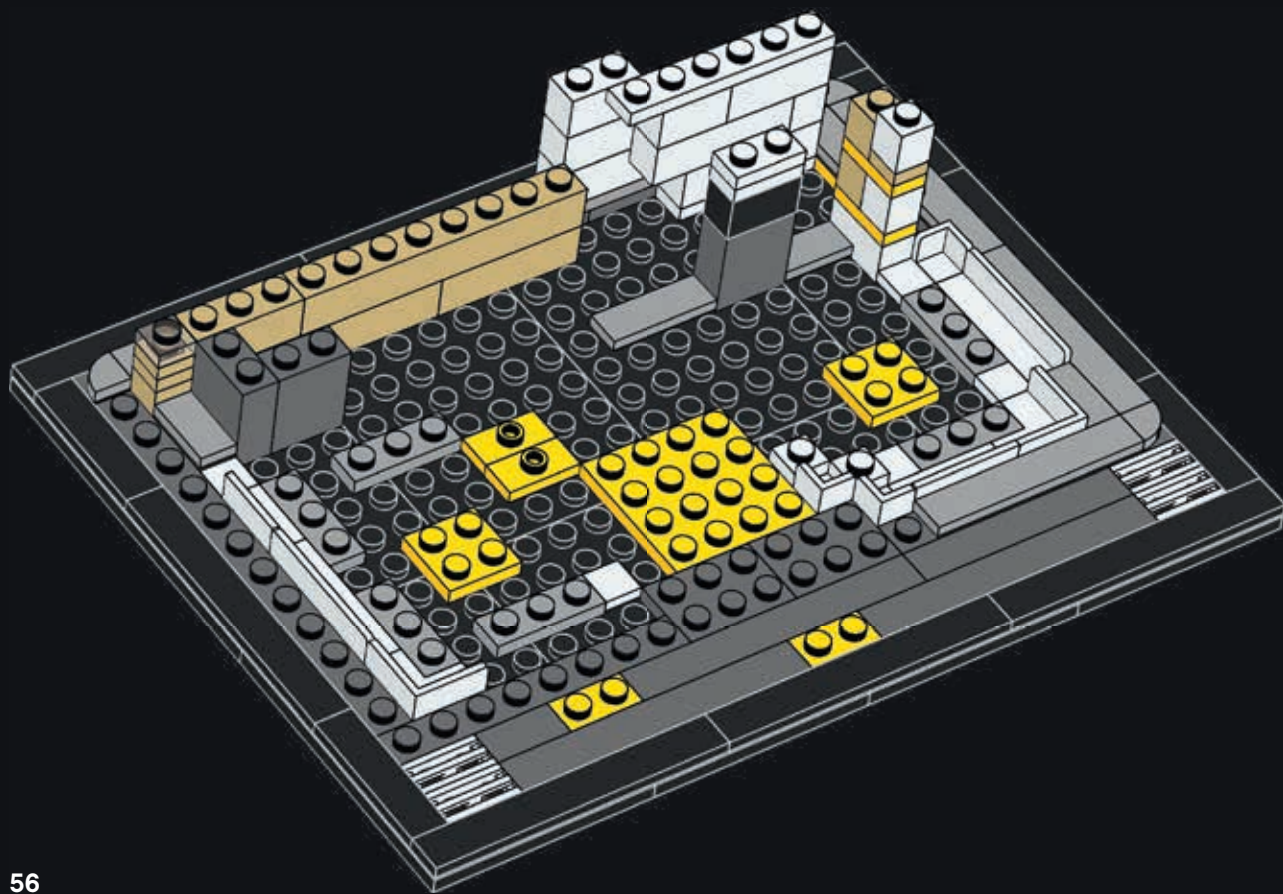



25

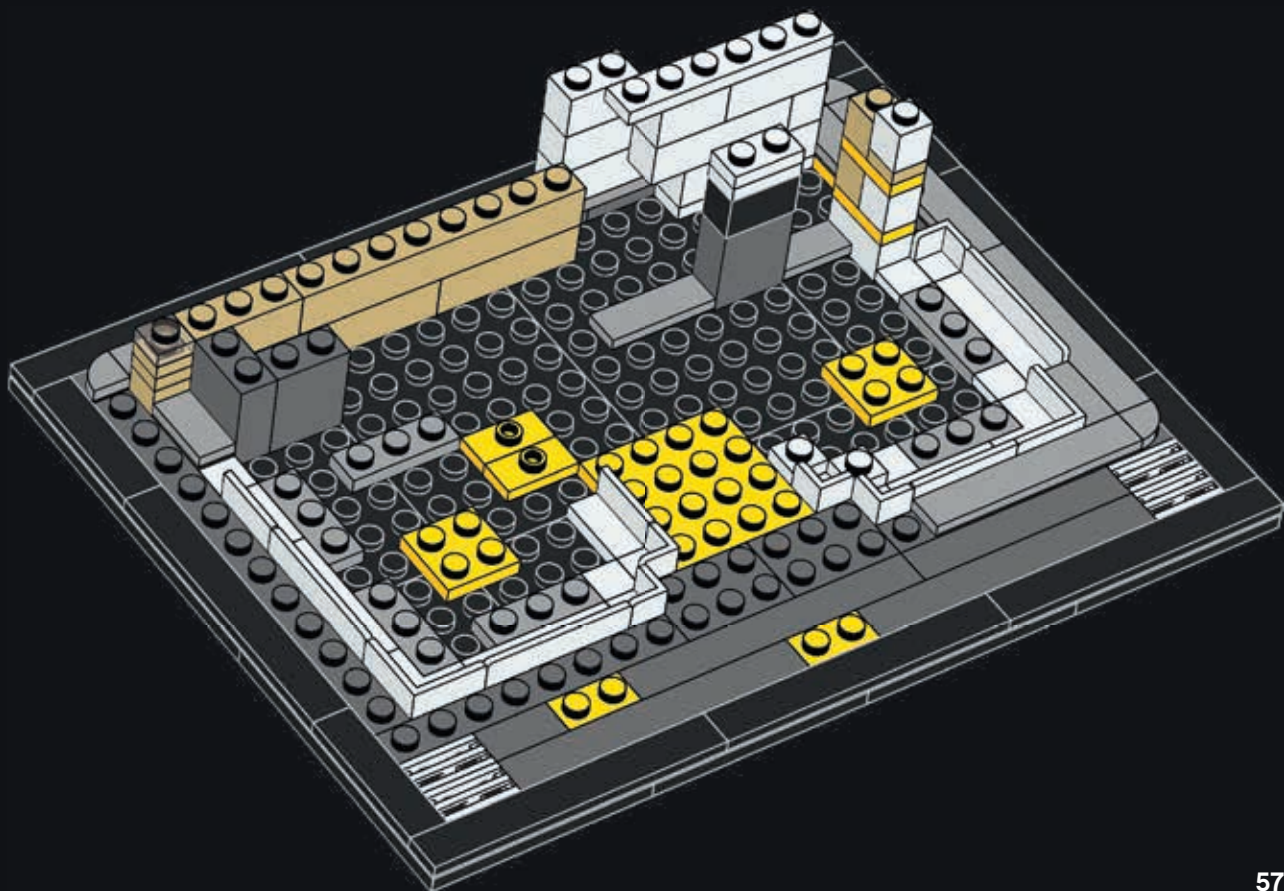



26

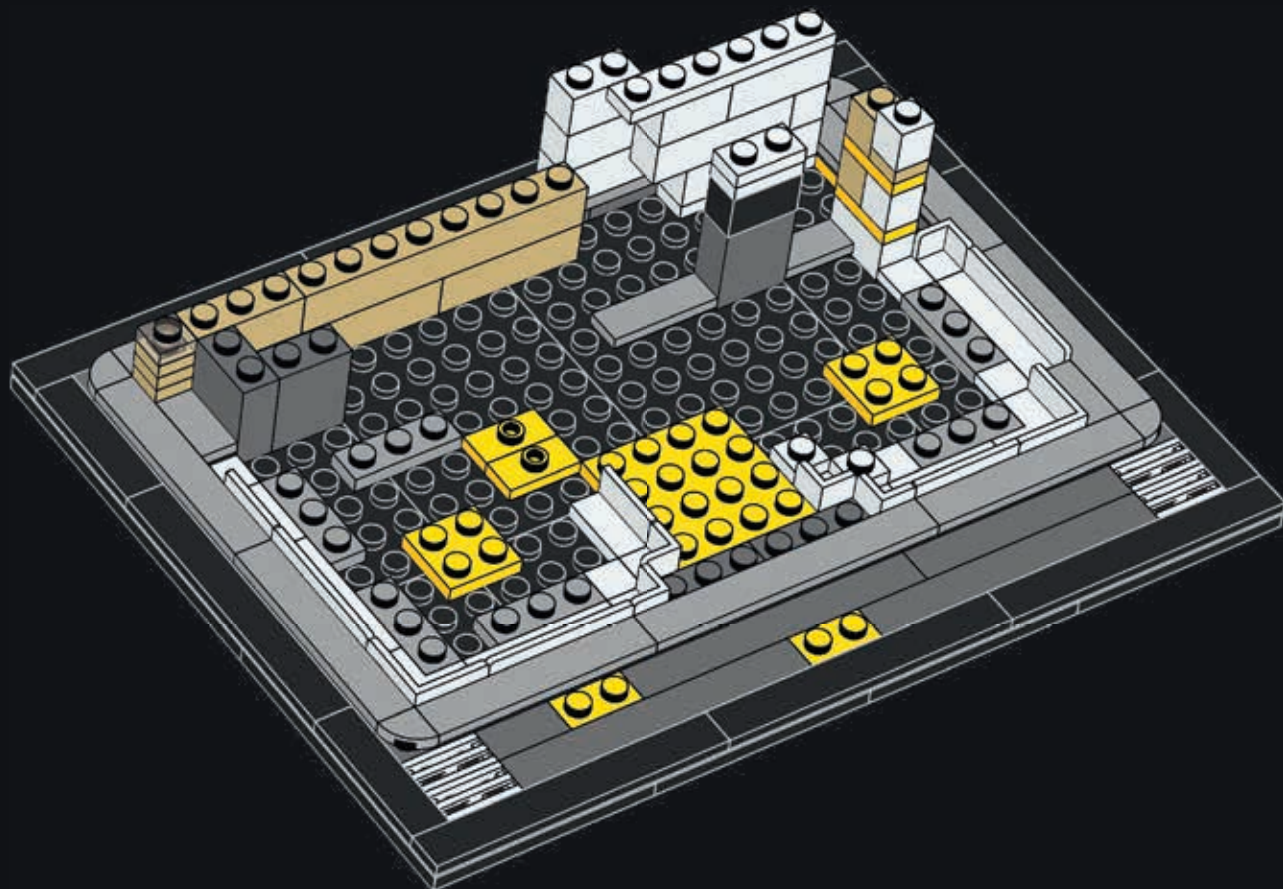



1x



2x

28

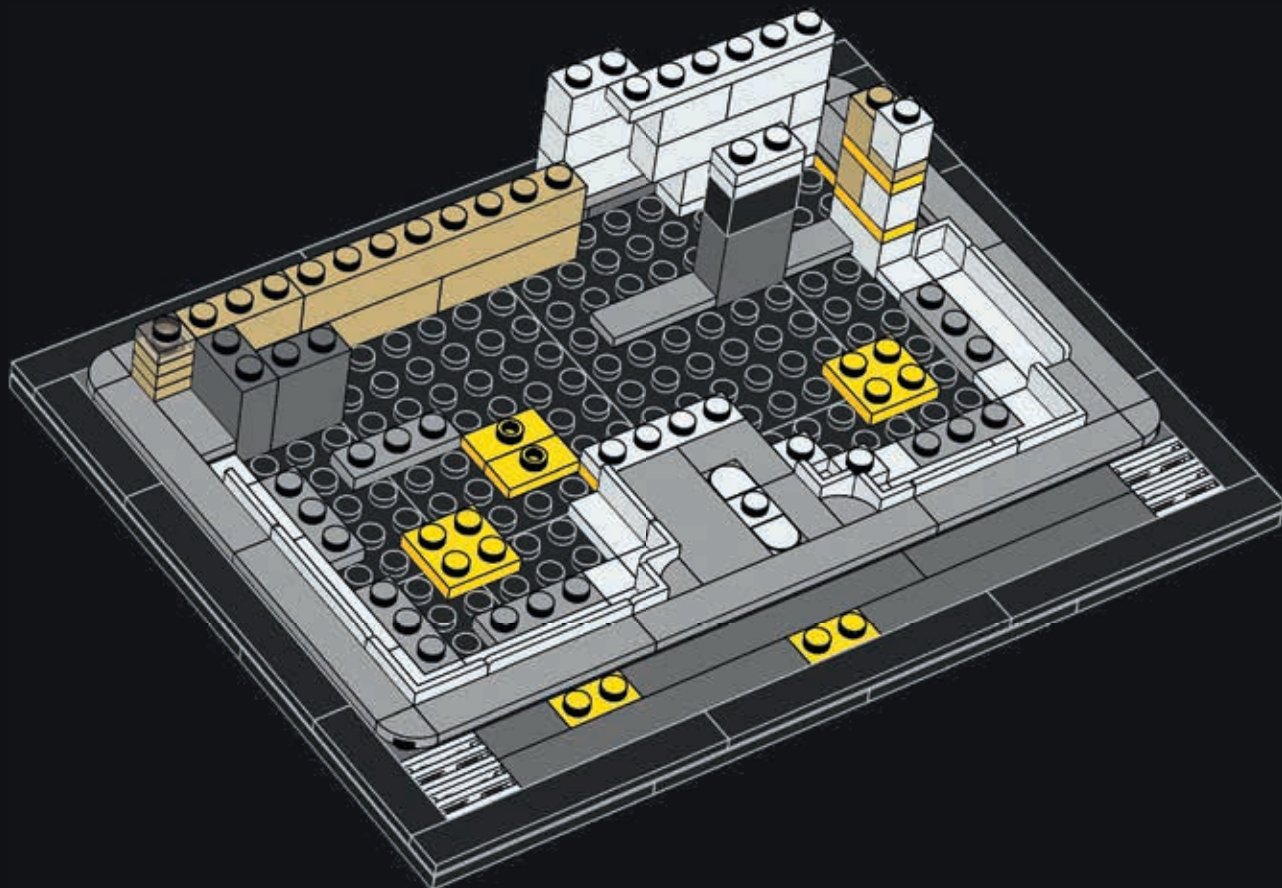



2x

29

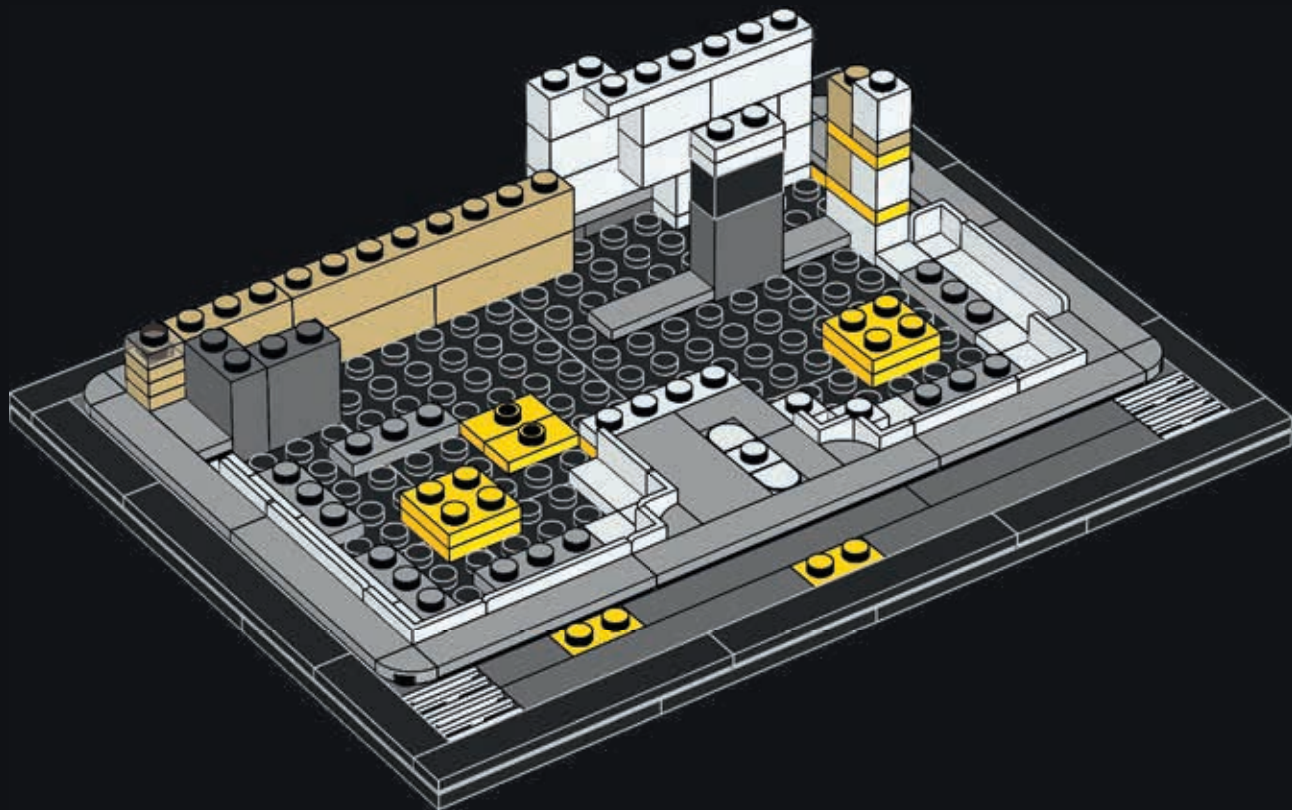



31

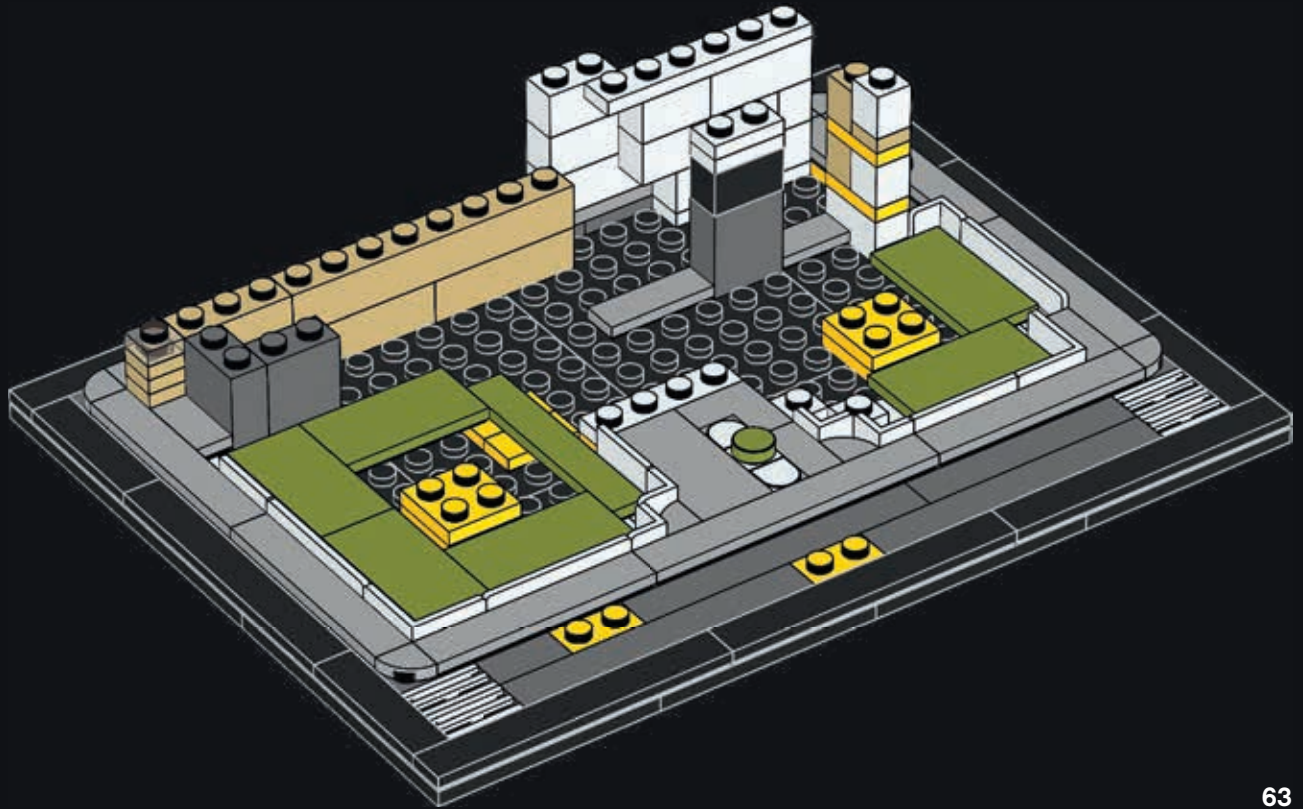



3x

33

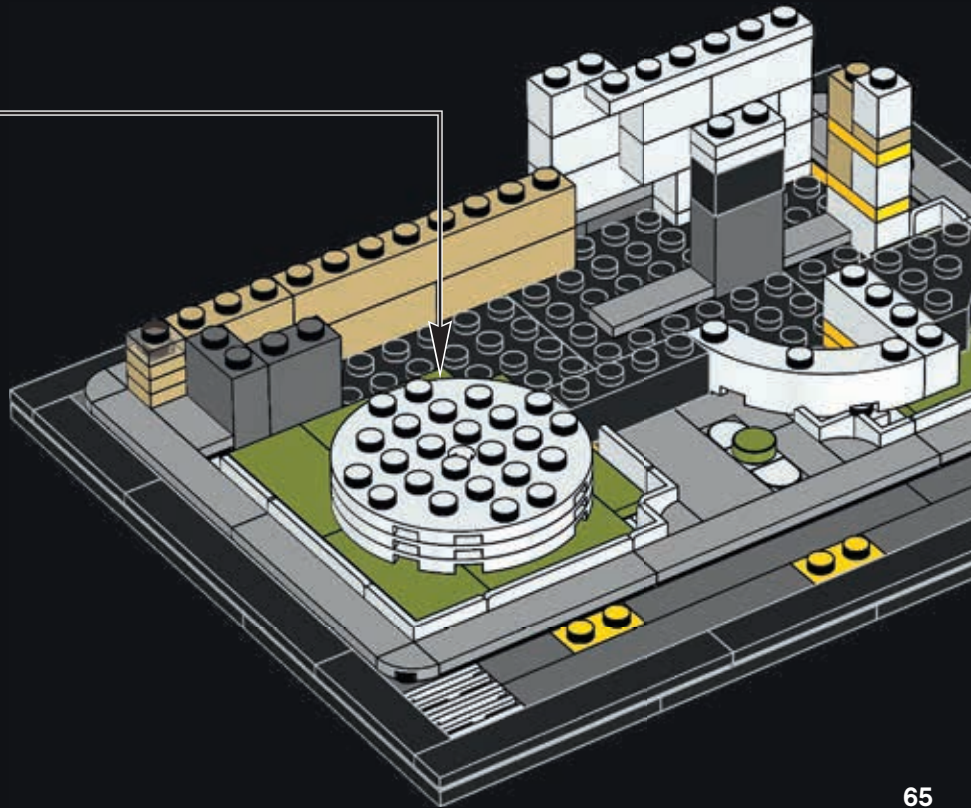
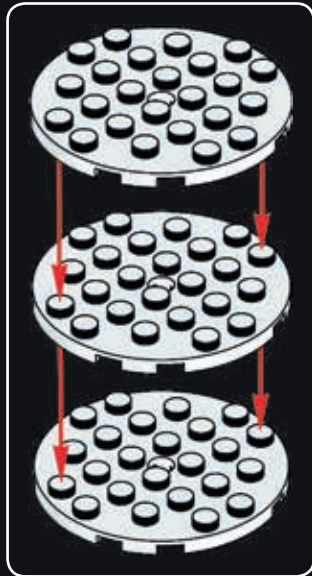

Frank Lloyd Wright originally wanted to call the Guggenheim the "Archeseum," which means "to see from the highest."

Frank Lloyd Wright souhaitait à l'origine appeler le Guggenheim l' « Archeseum », ce qui signifie « voir depuis le point le plus haut ».

Frank Lloyd Wright quiso que el Guggenheim se llamase « Archeseum », que significa « mirar desde lo más alto ».



©The Solomon R. Guggenheim Foundation, New York



34

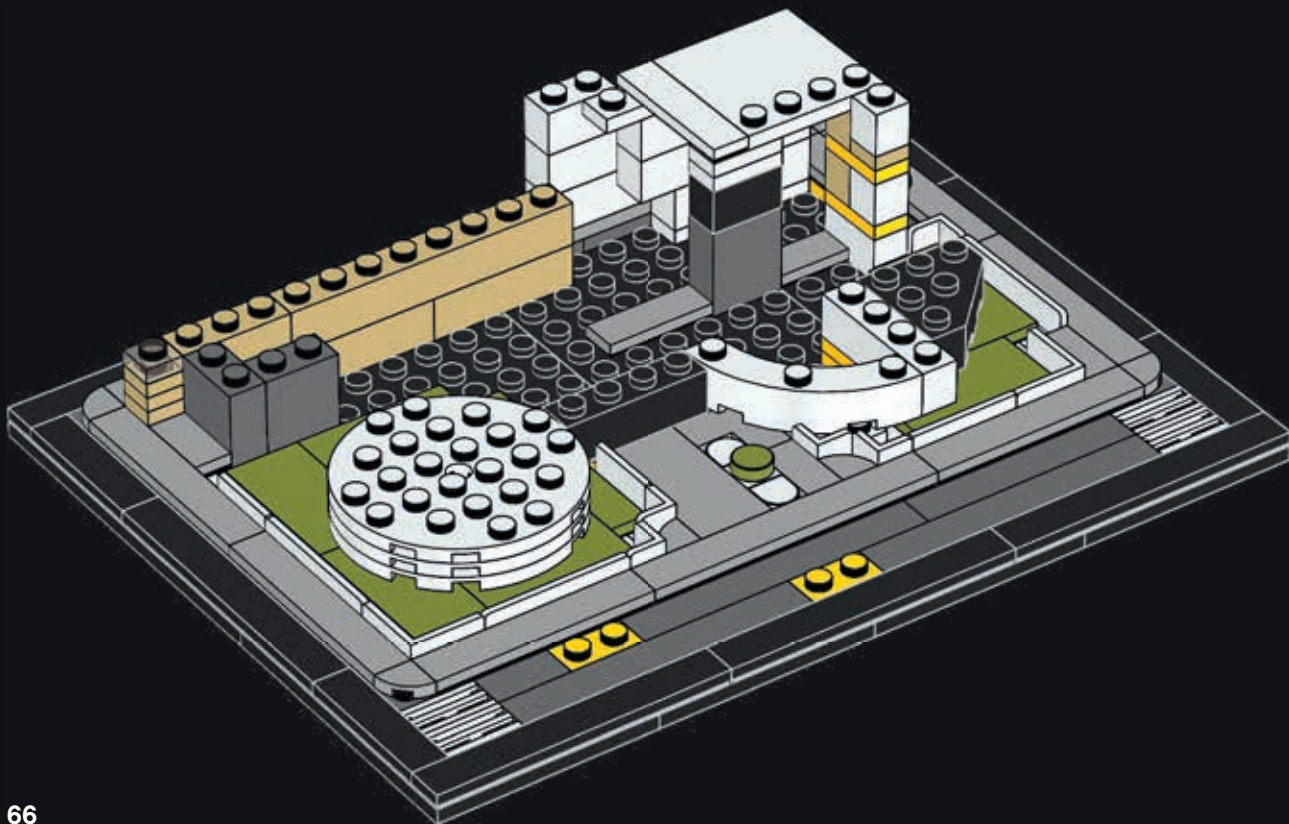



1x



1x

35

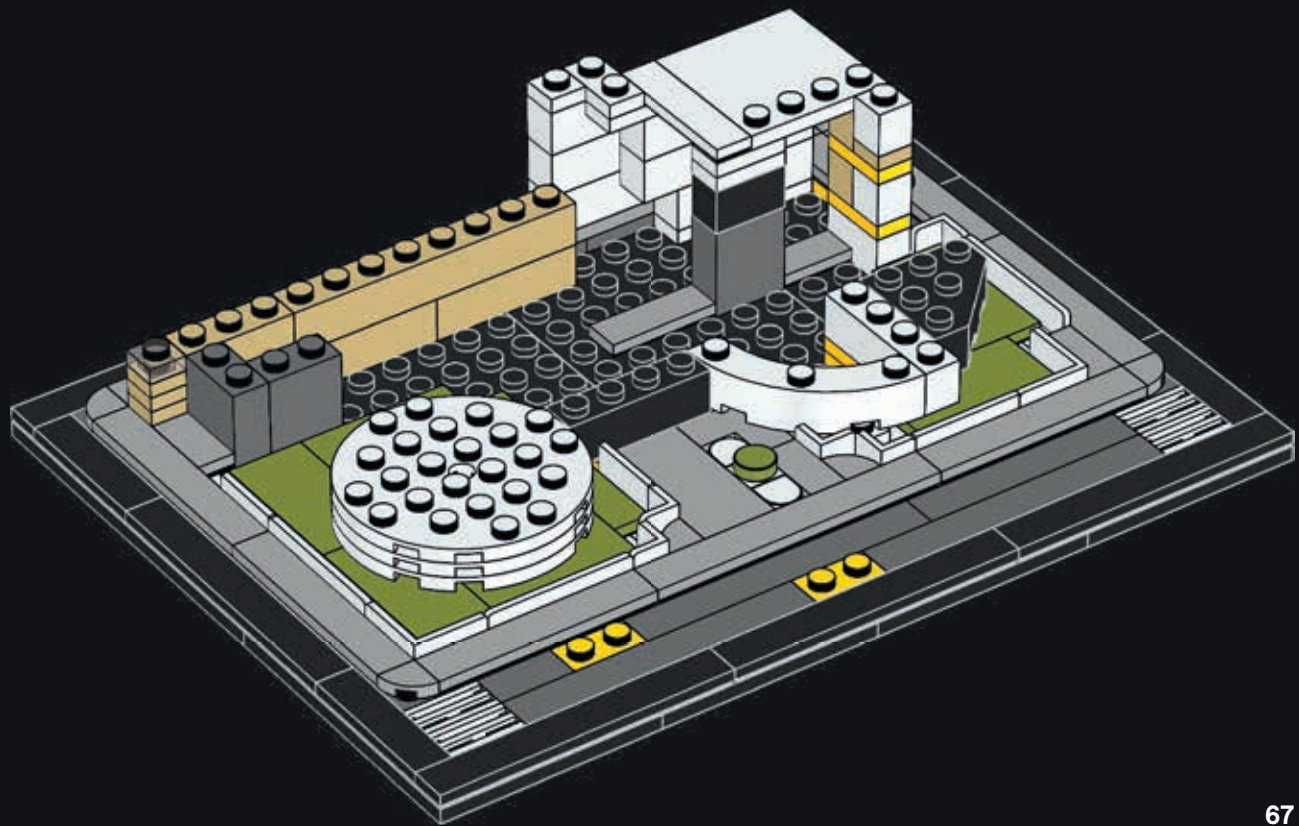

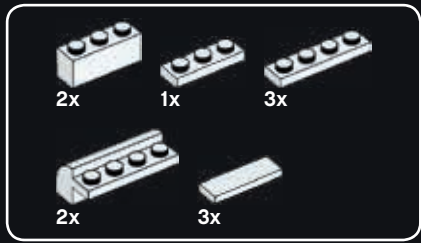

36

1

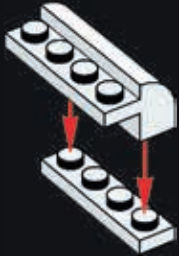

2

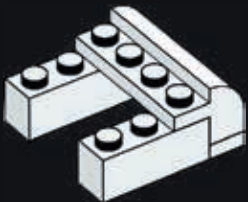

3

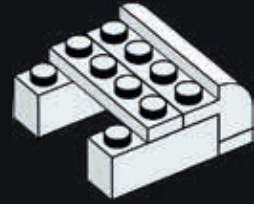

4

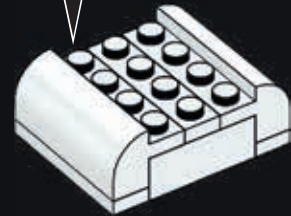
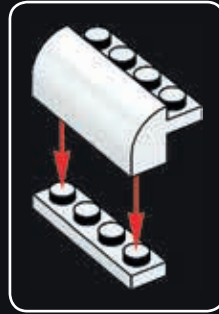

5

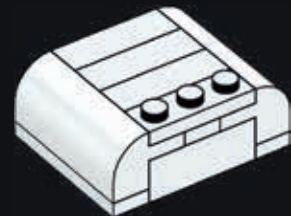

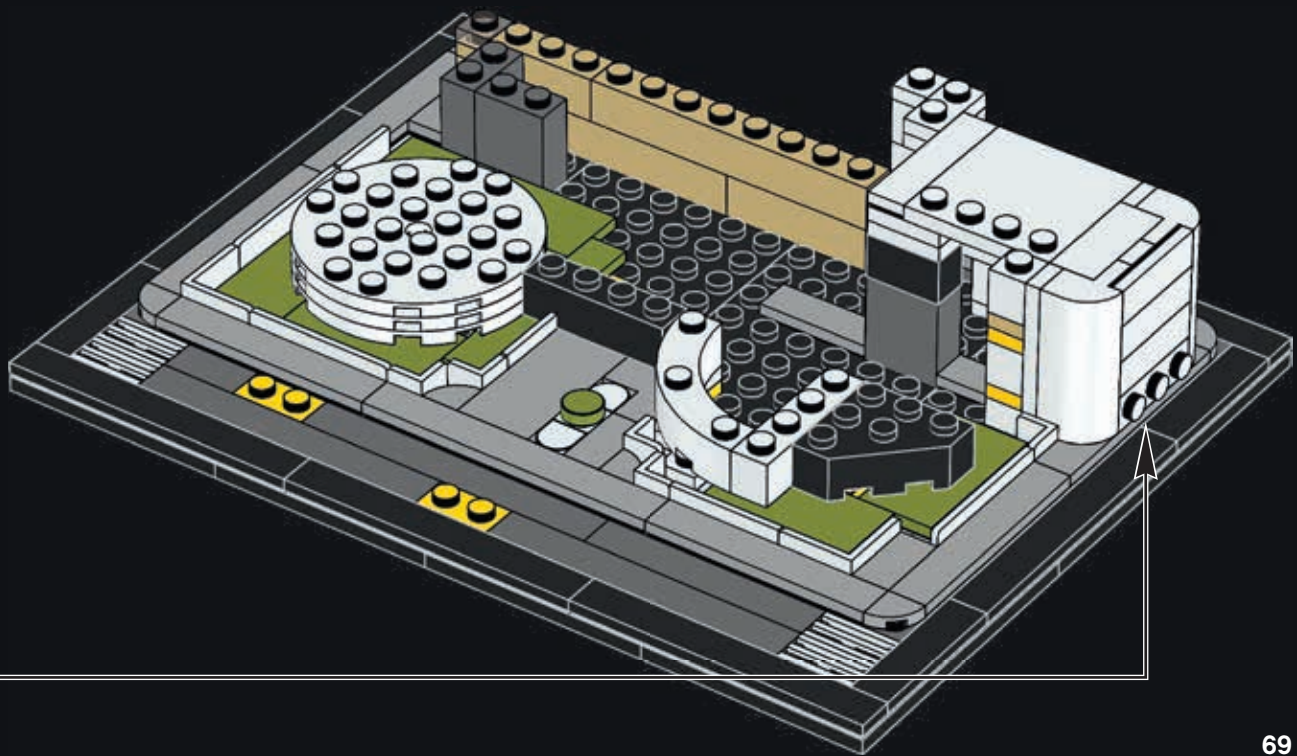

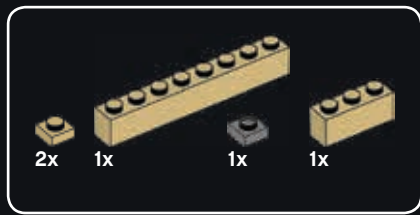

37

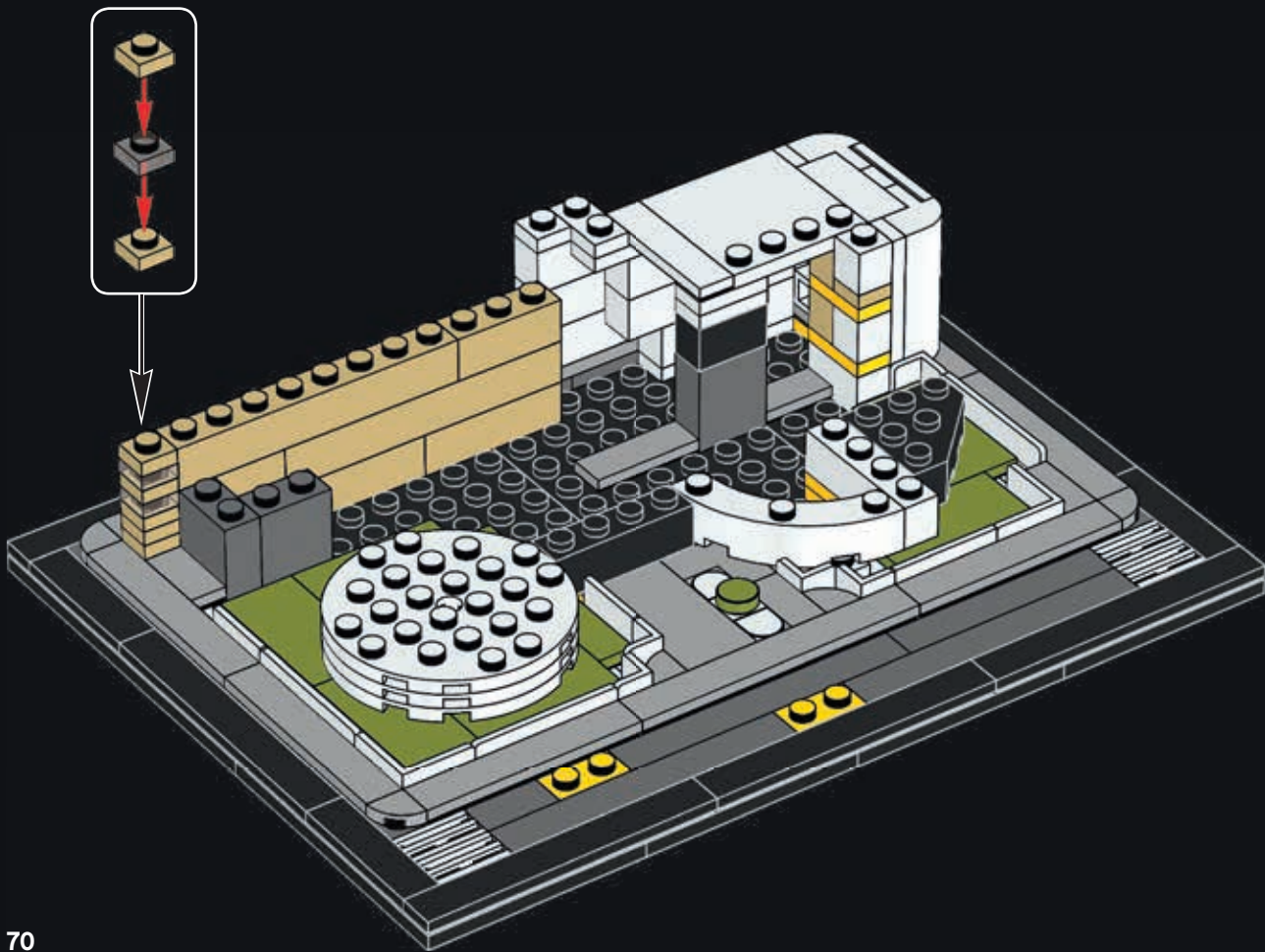



1x

38

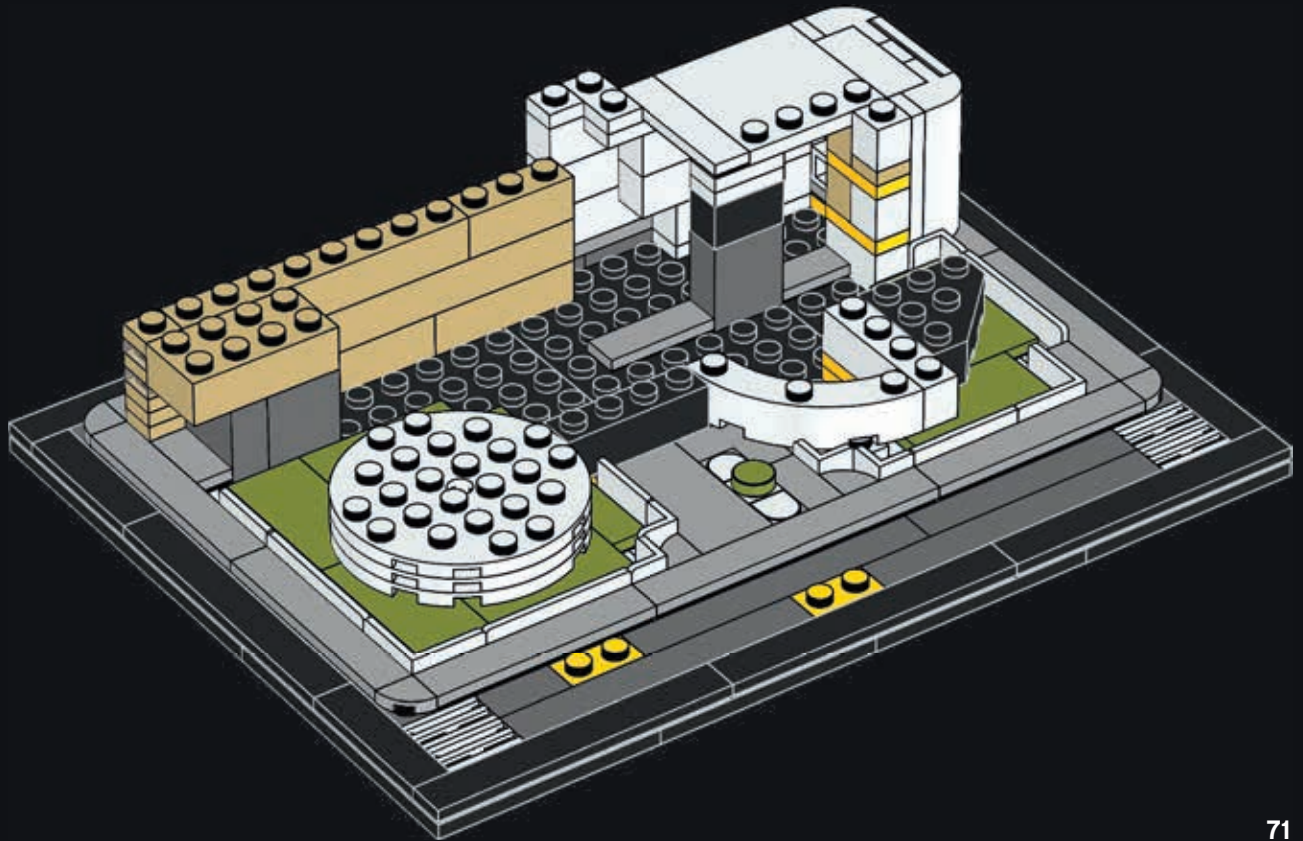

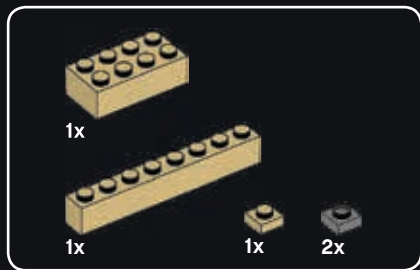

39

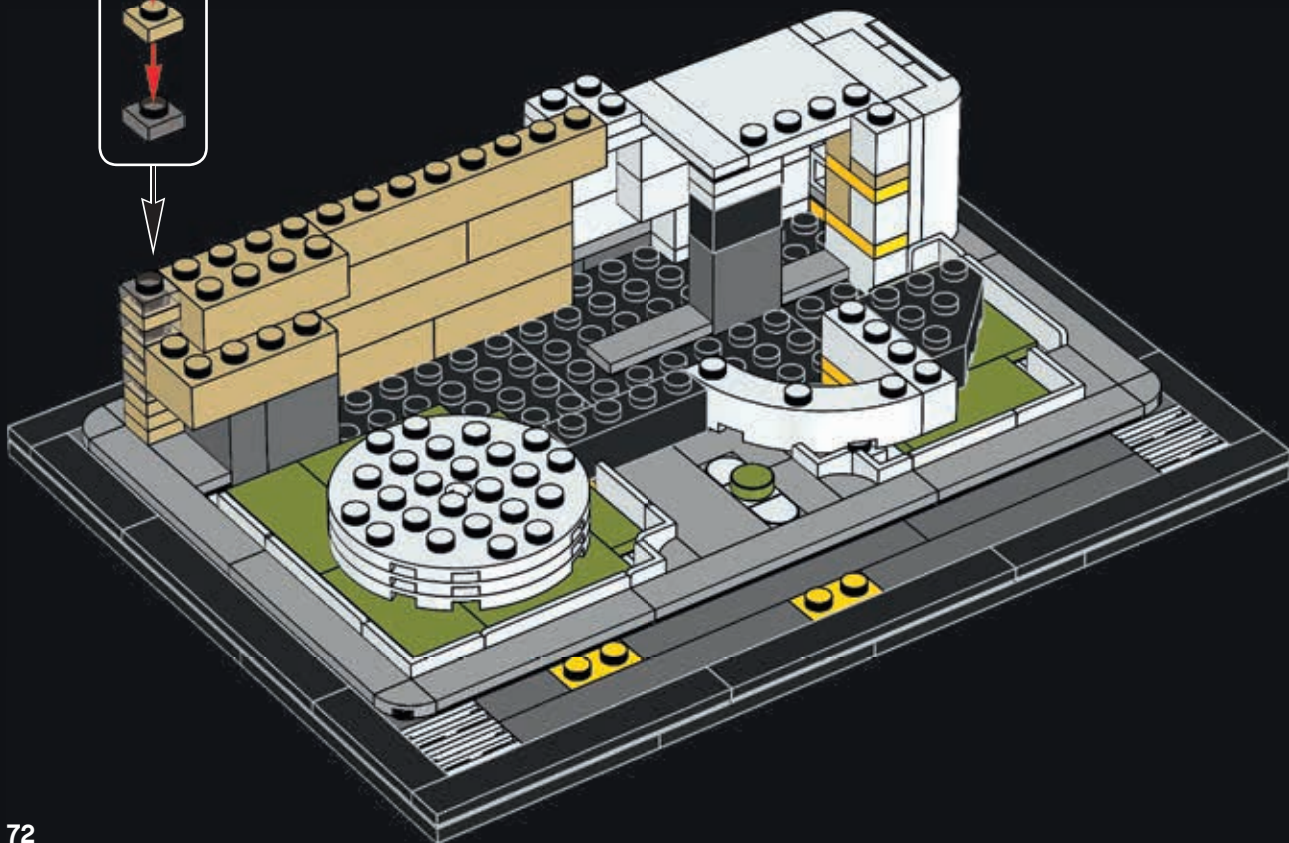



40

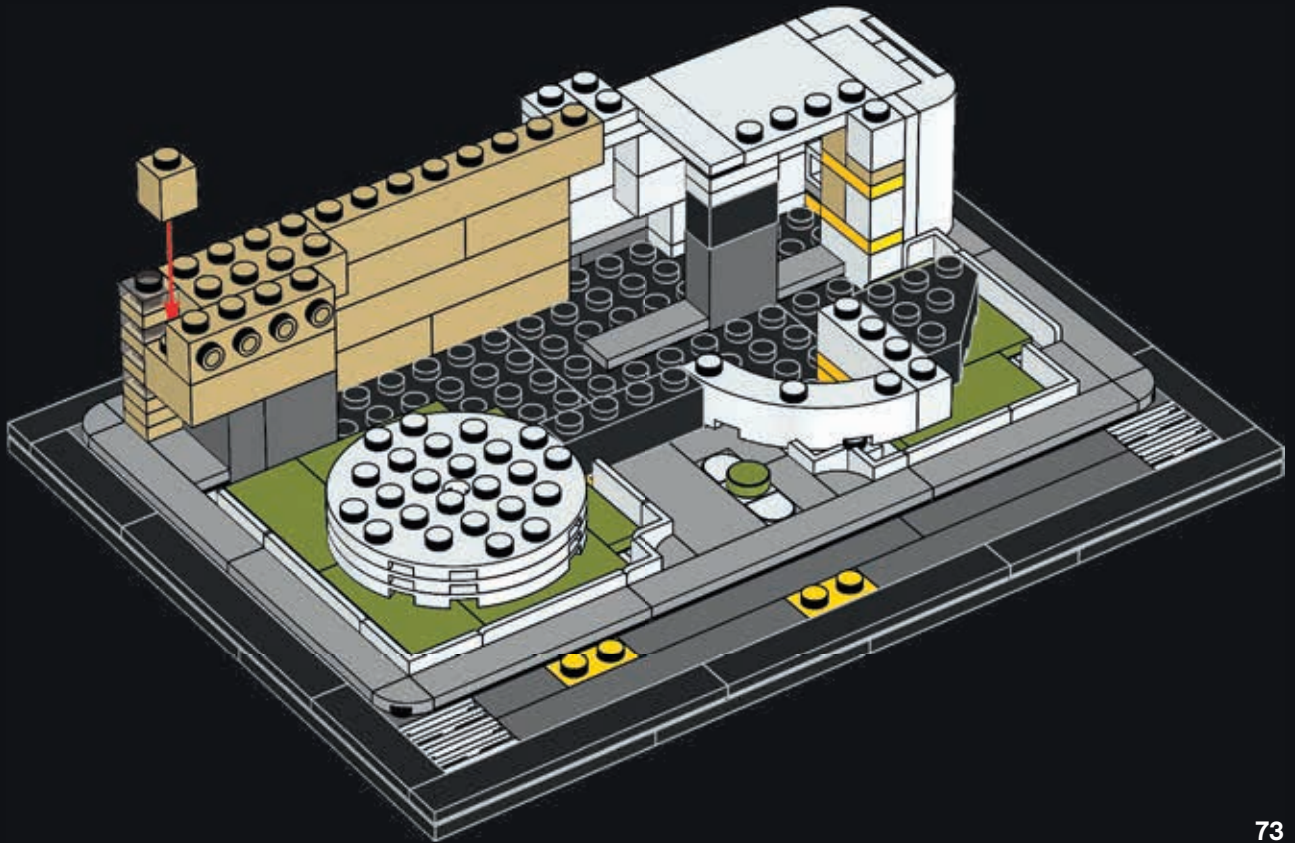

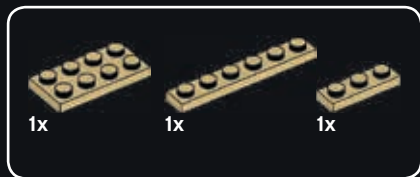

41

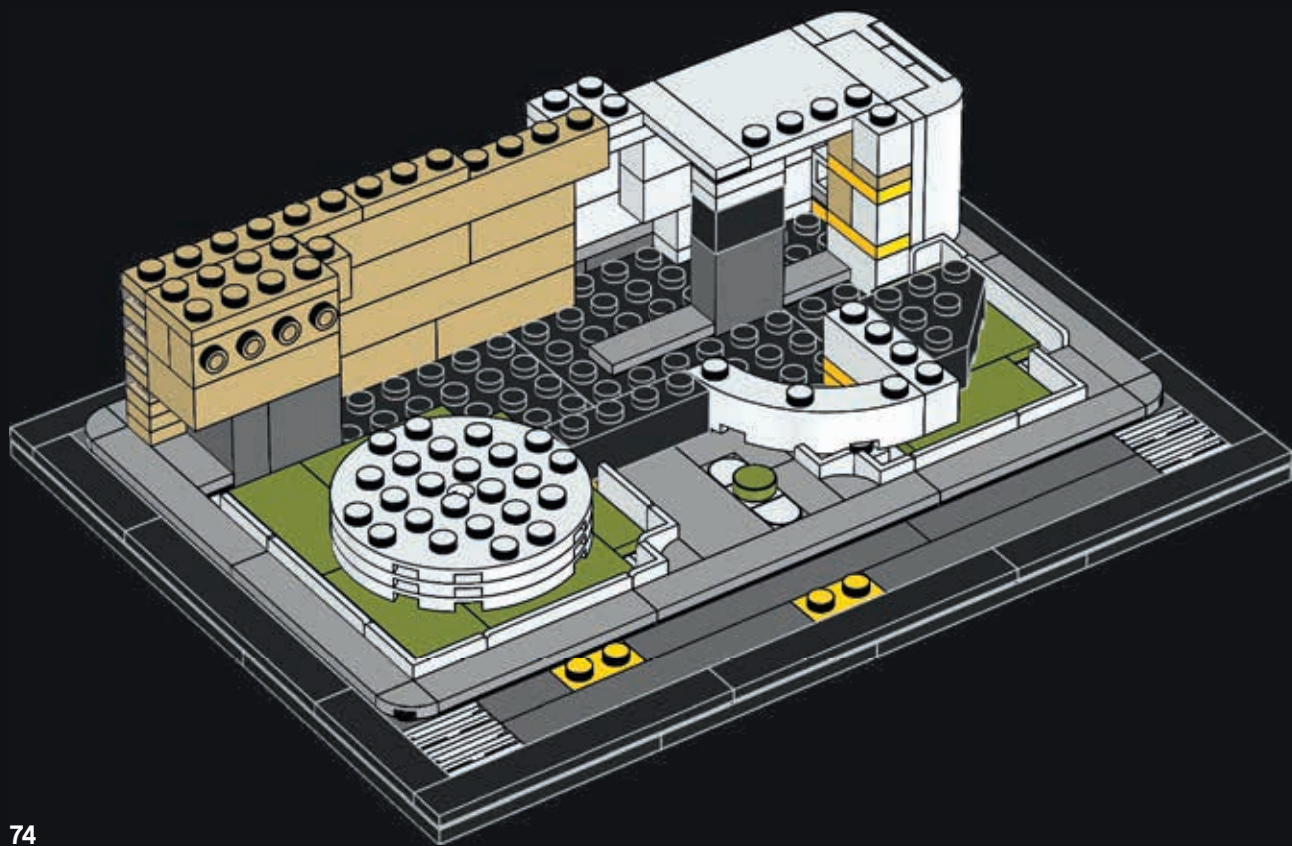



42

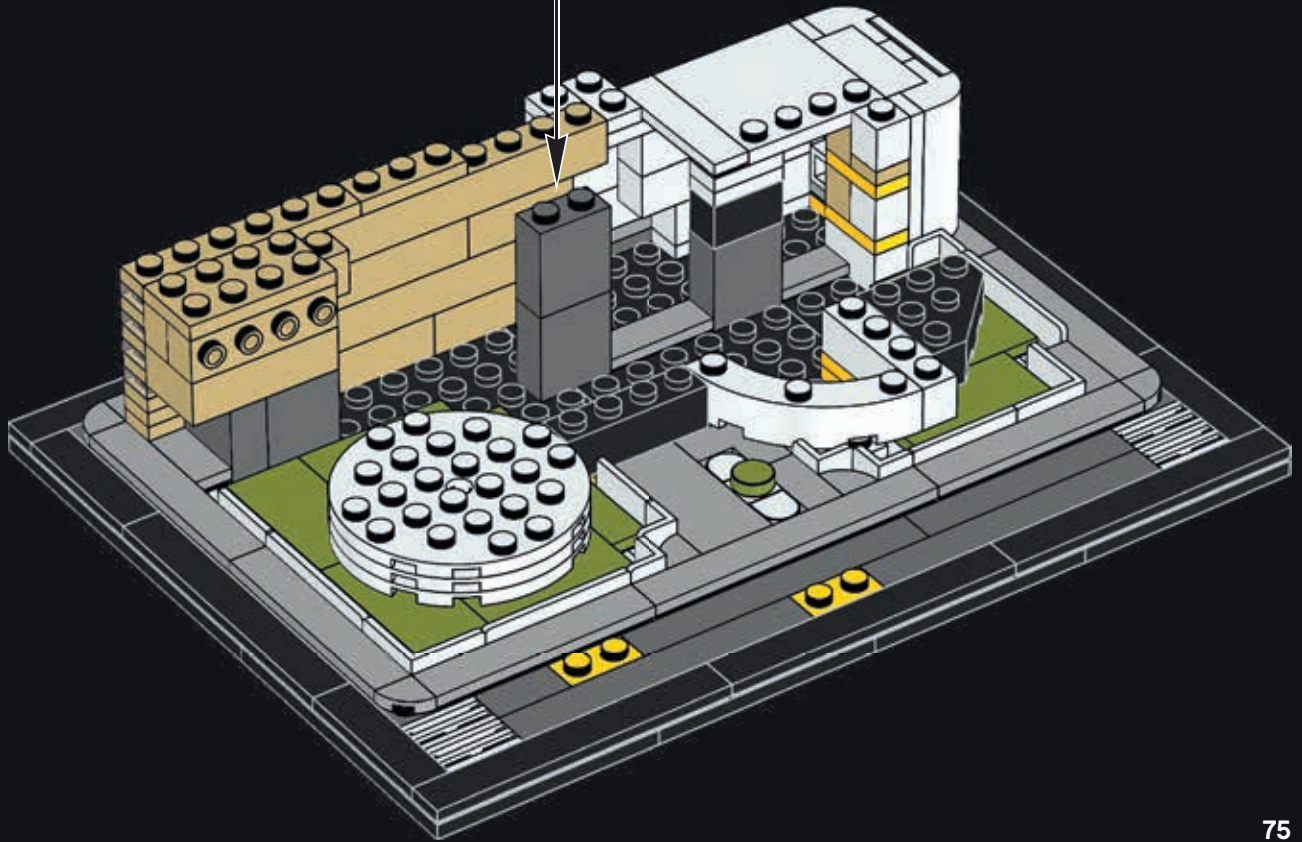
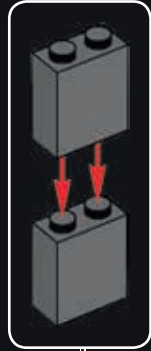



43

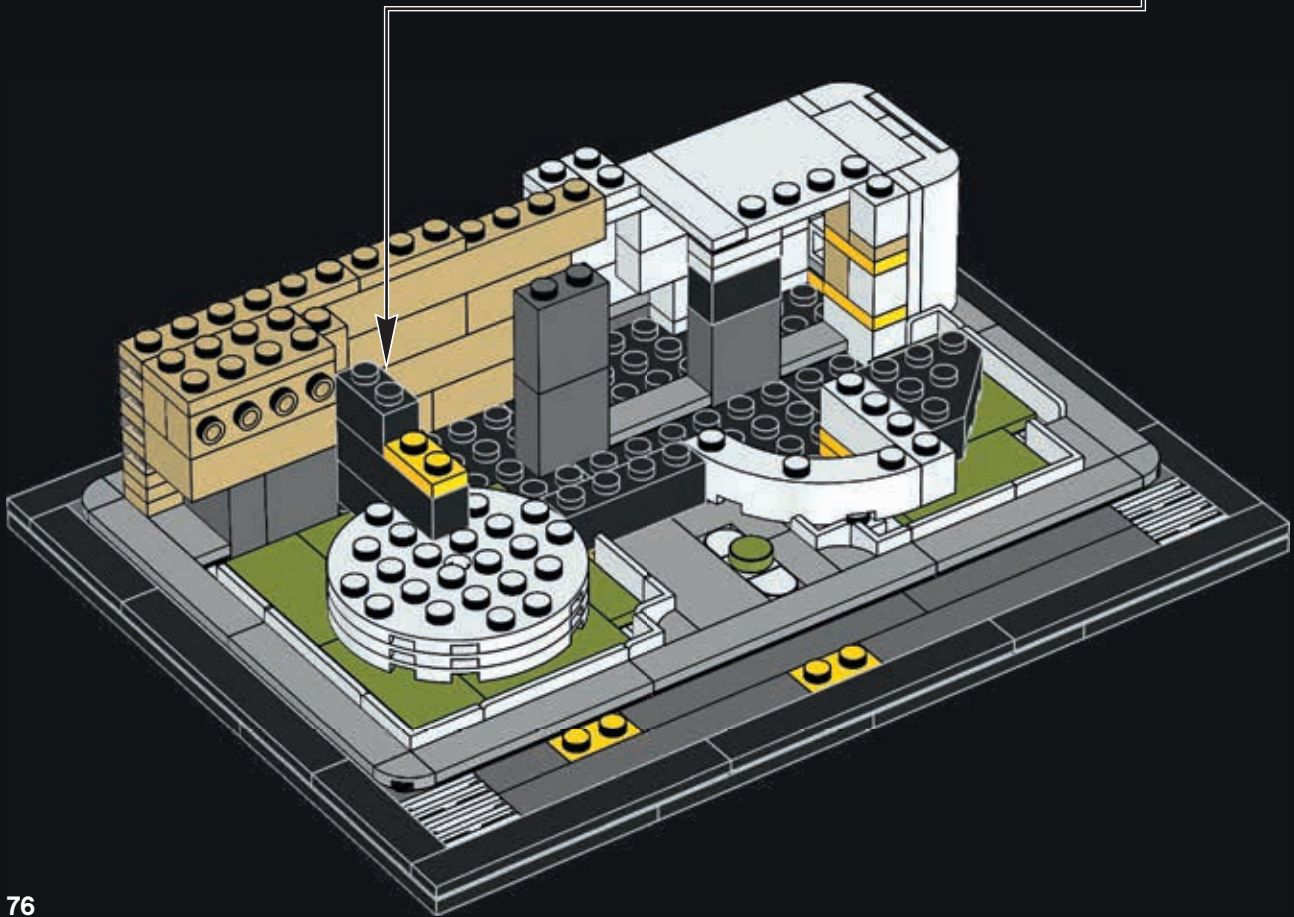
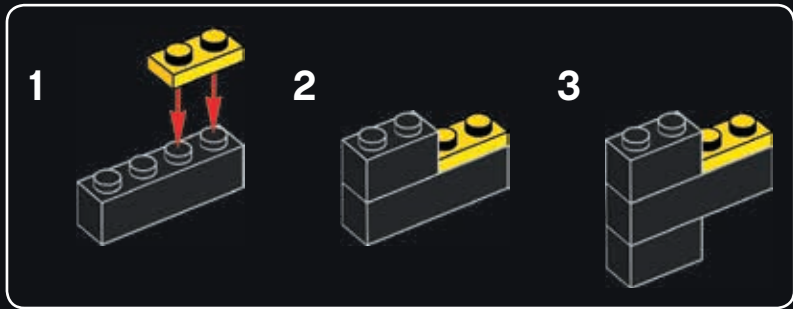

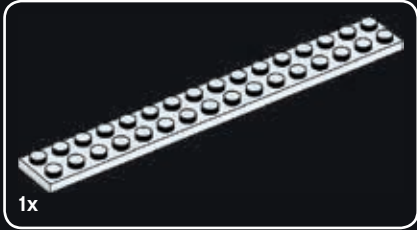
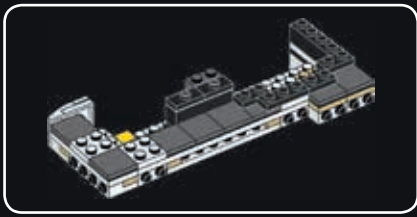

44



45





1x

46



1x

2x

47





48

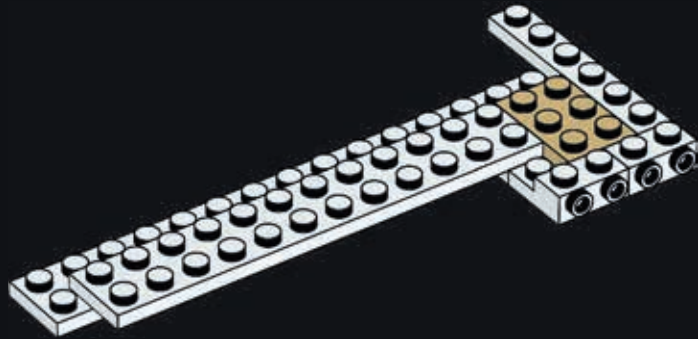

49

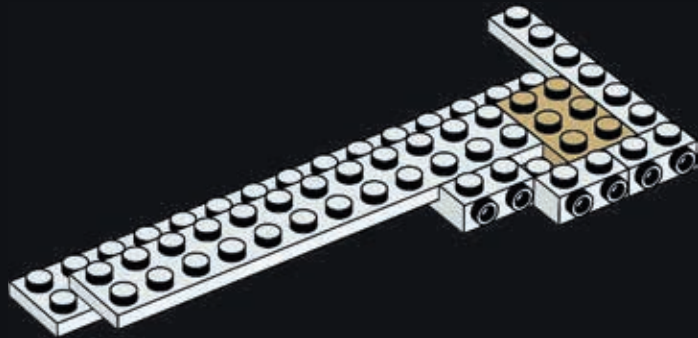

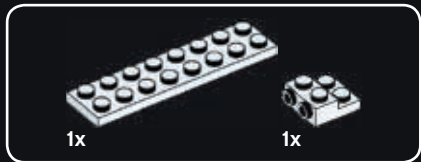

50

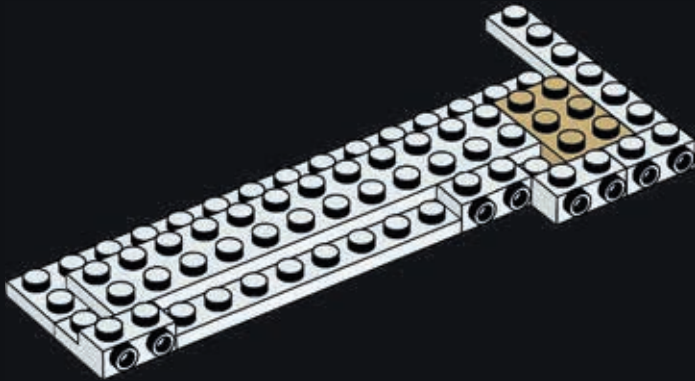

51

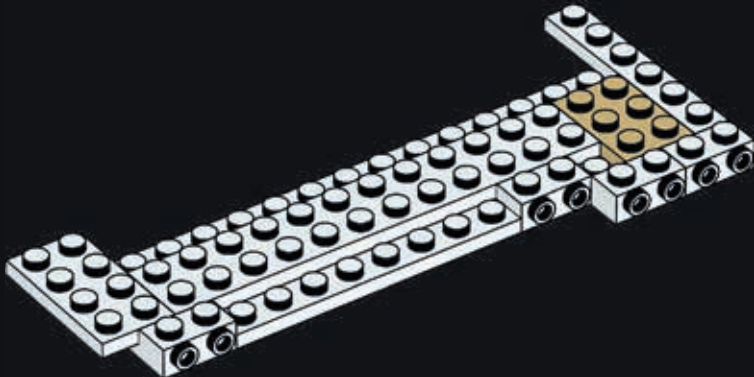



2x

52

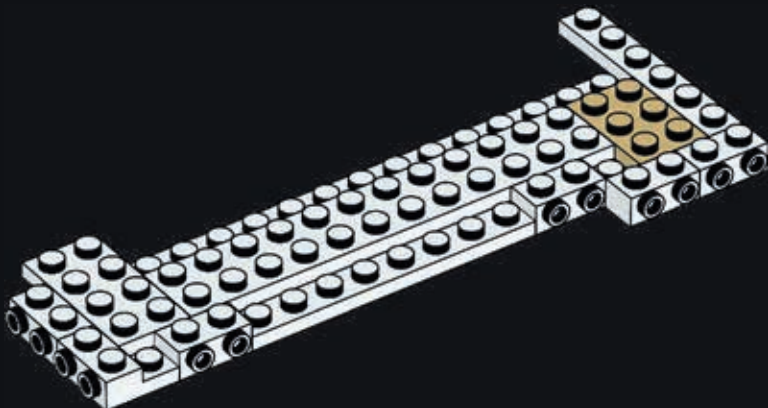

1x

53

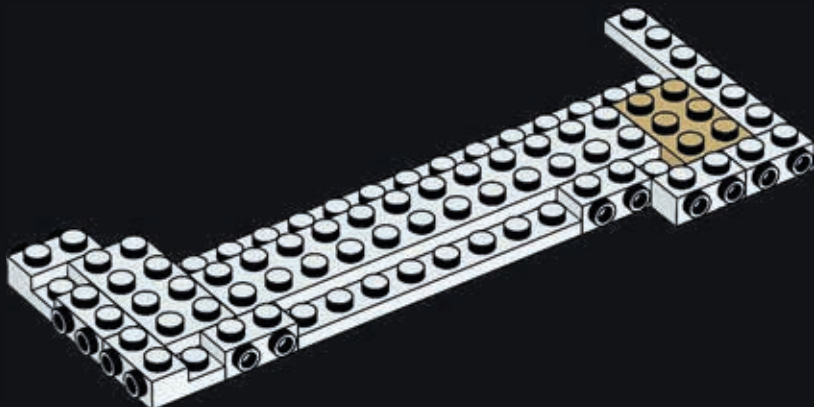



1x



5x

54

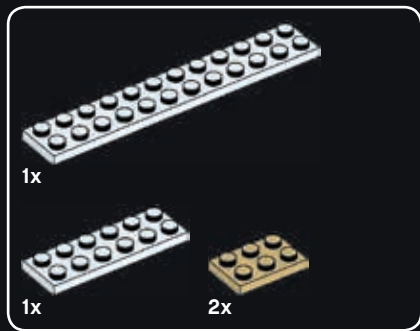
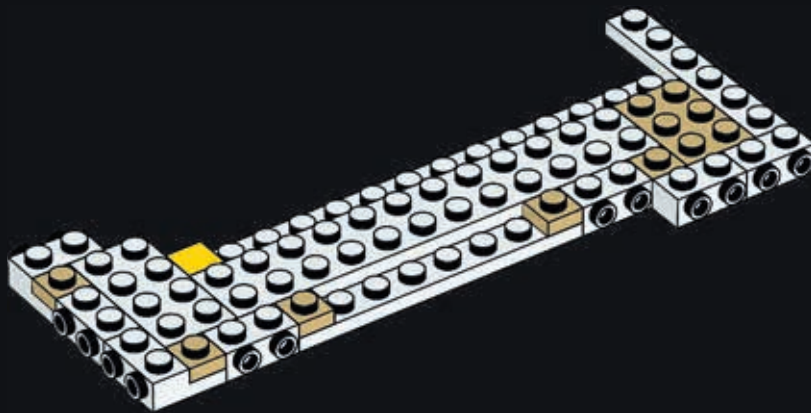

1x

1x

2x

55

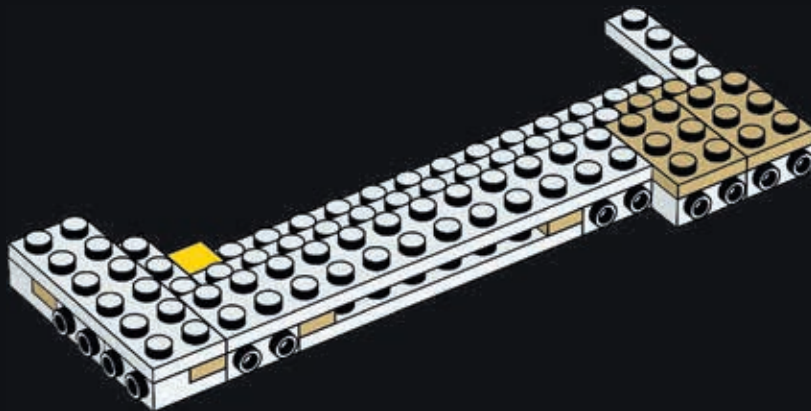



56

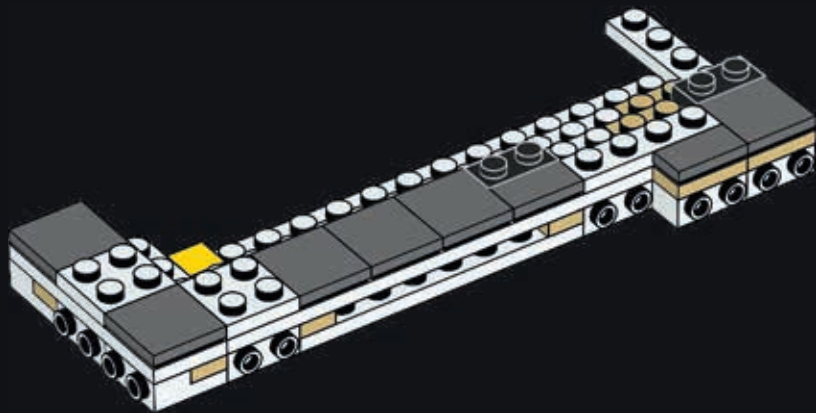

57

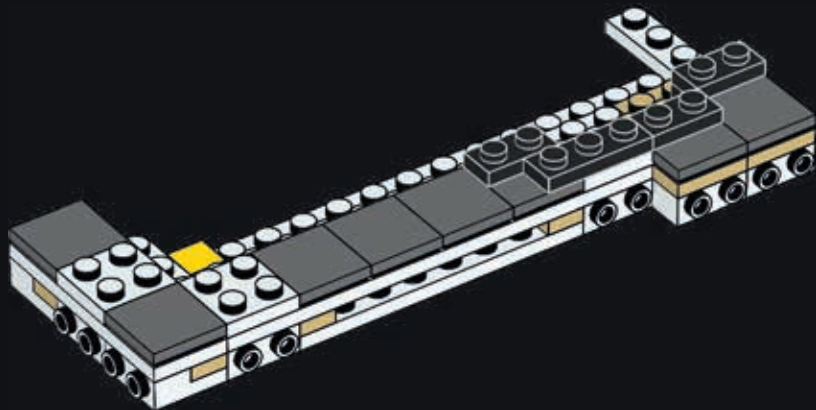

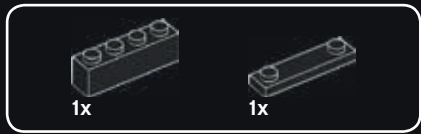

58

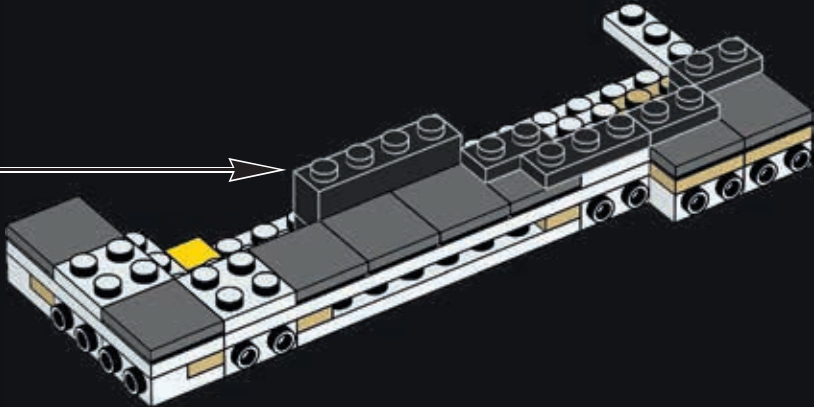
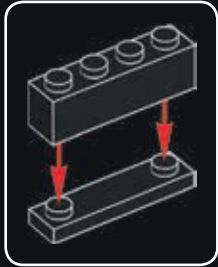

59

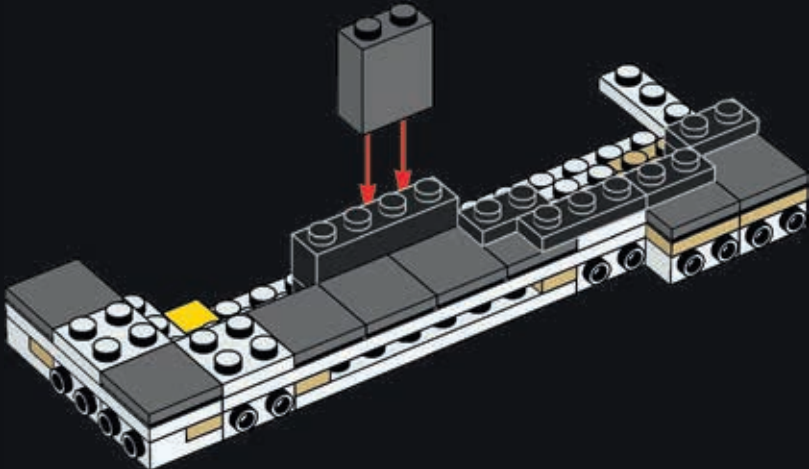



2x

60

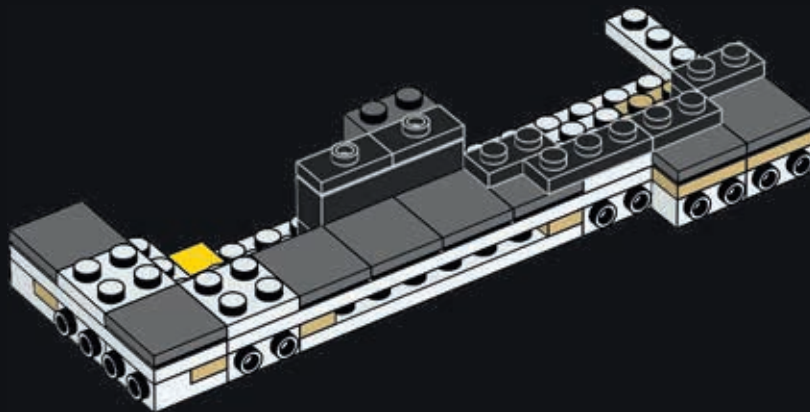

1x

61

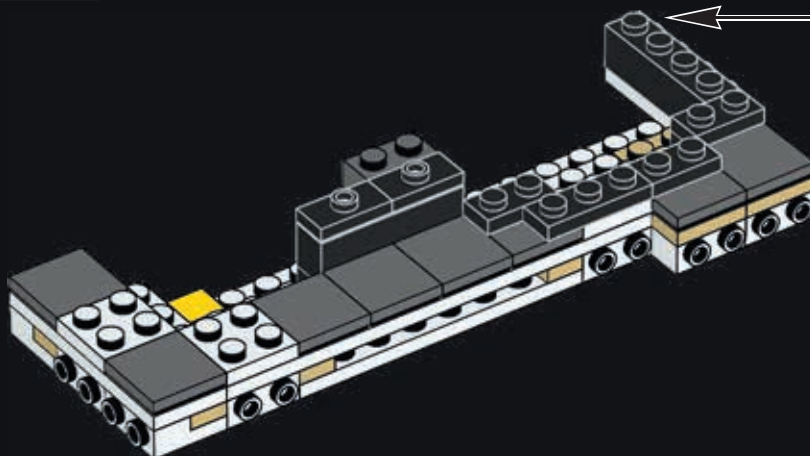



62

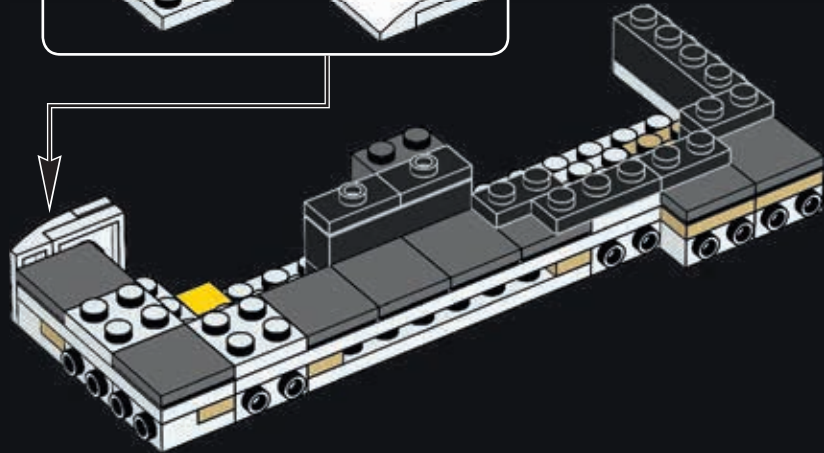
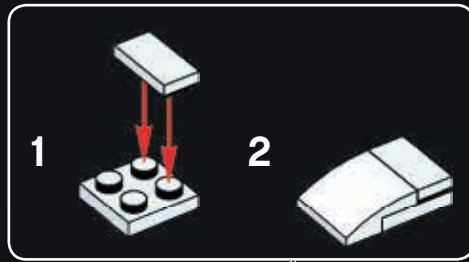

63

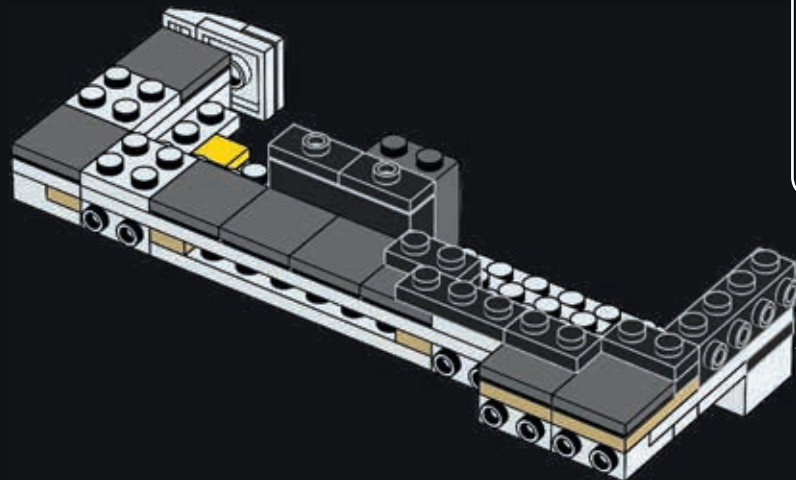
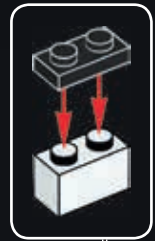

64

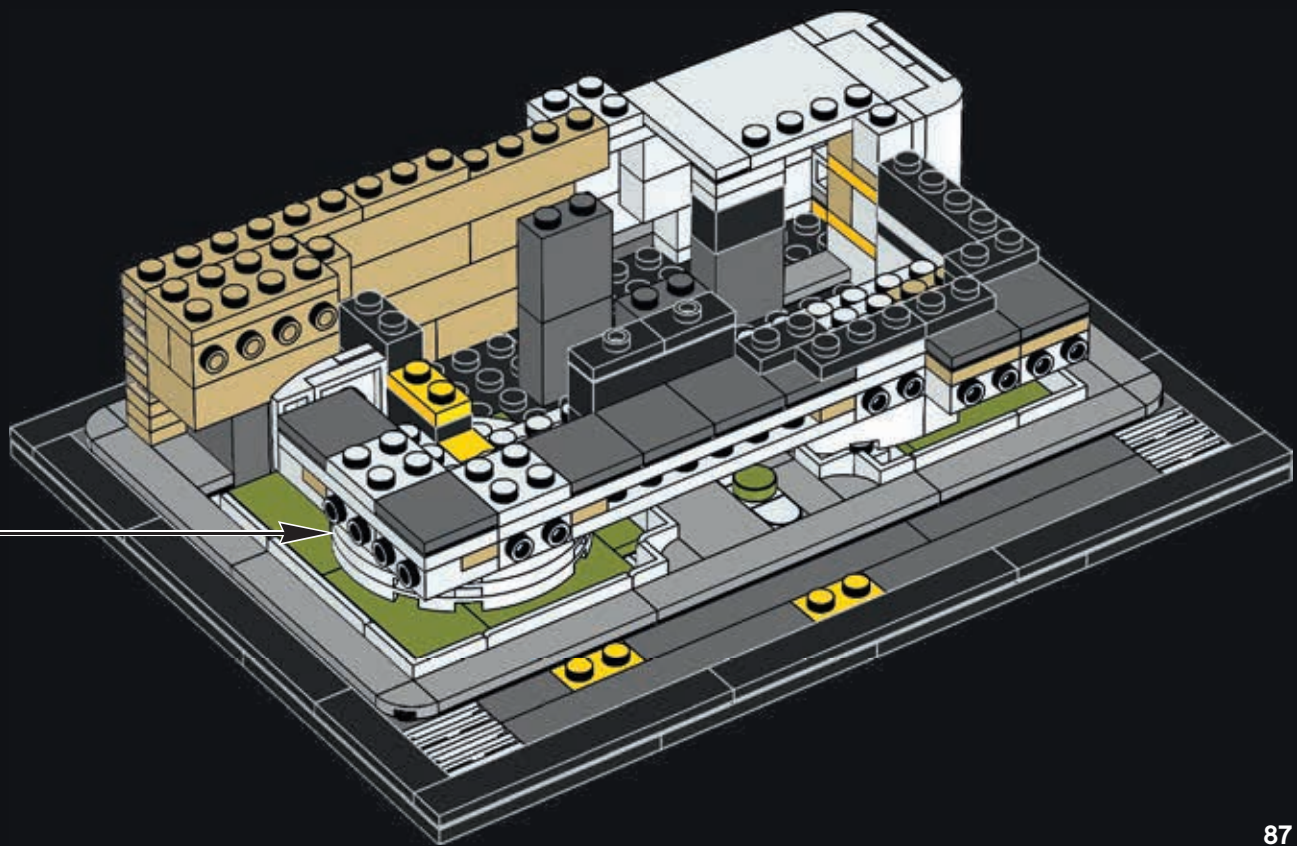

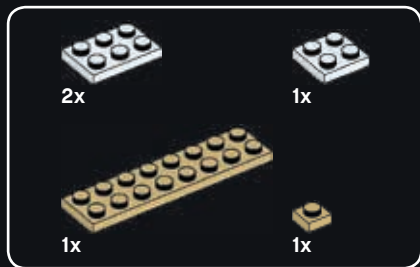

65

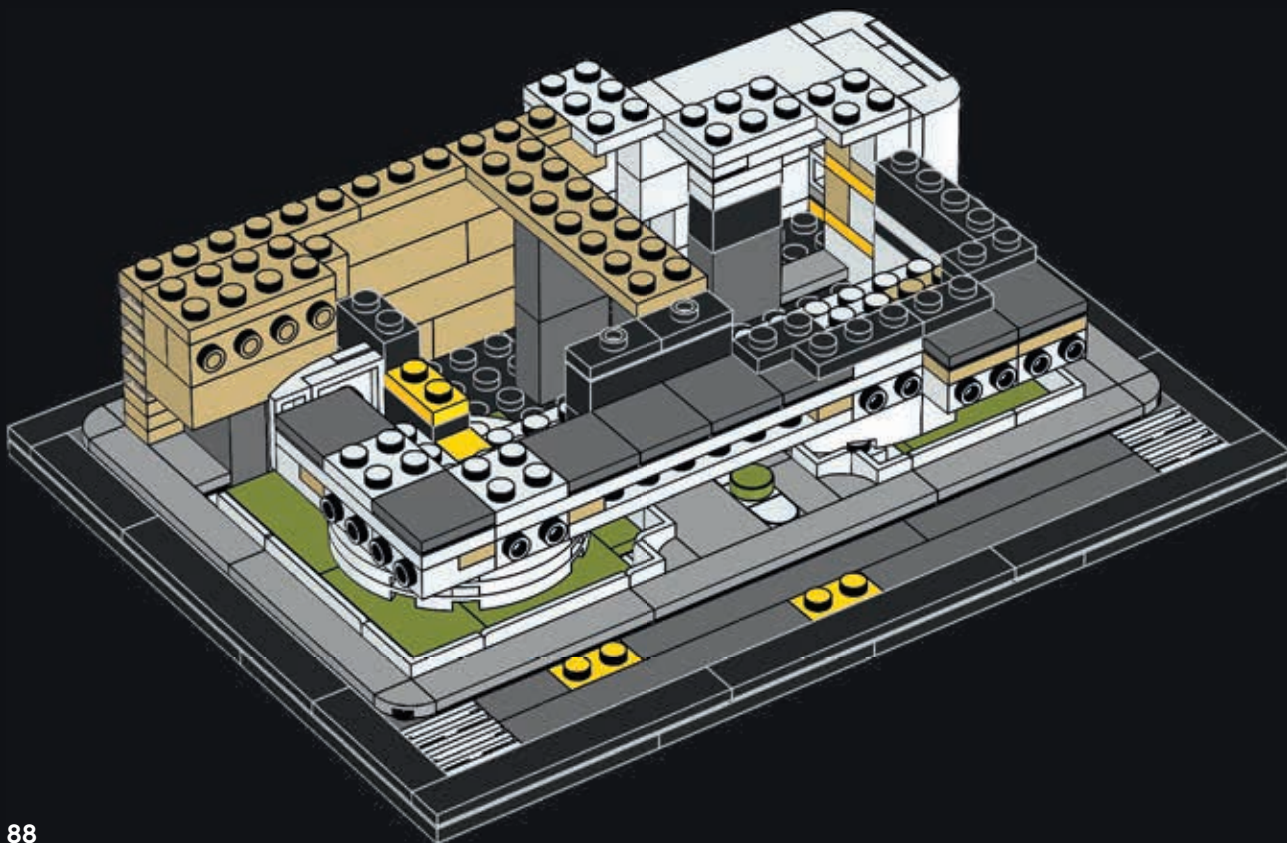

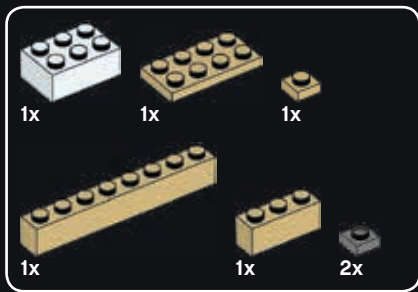

66

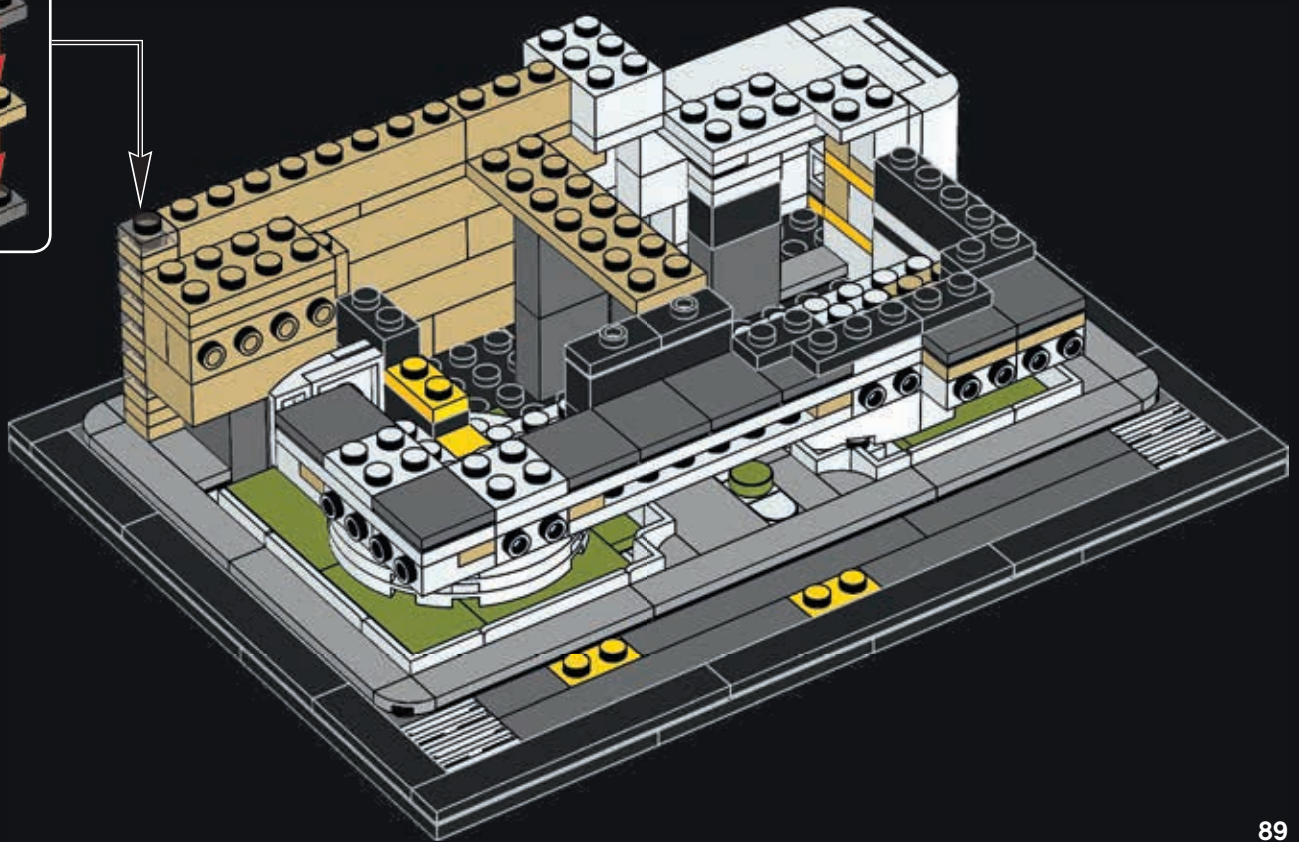
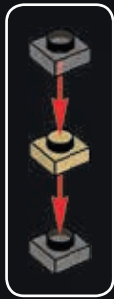

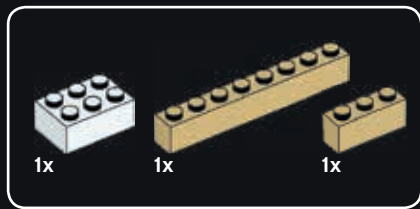

67

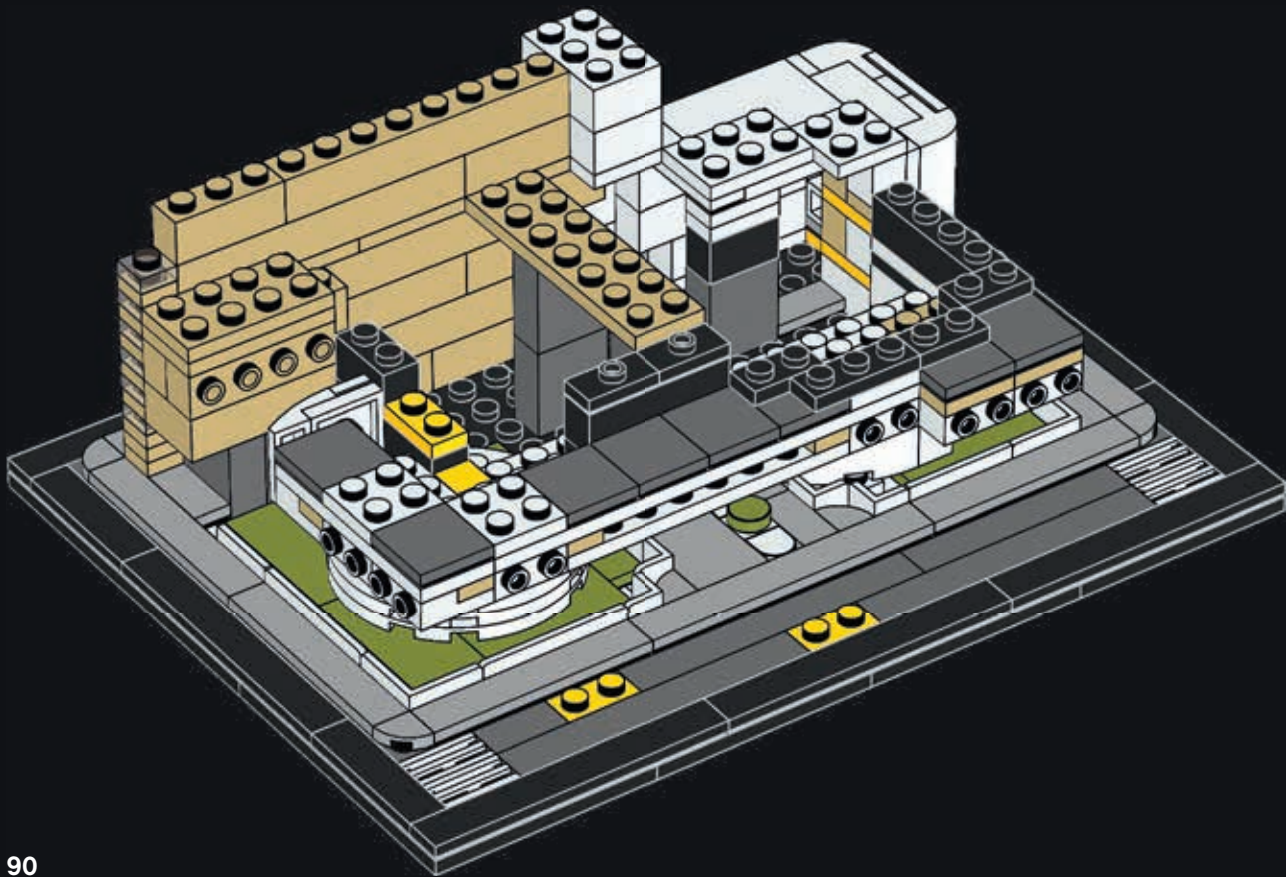



68

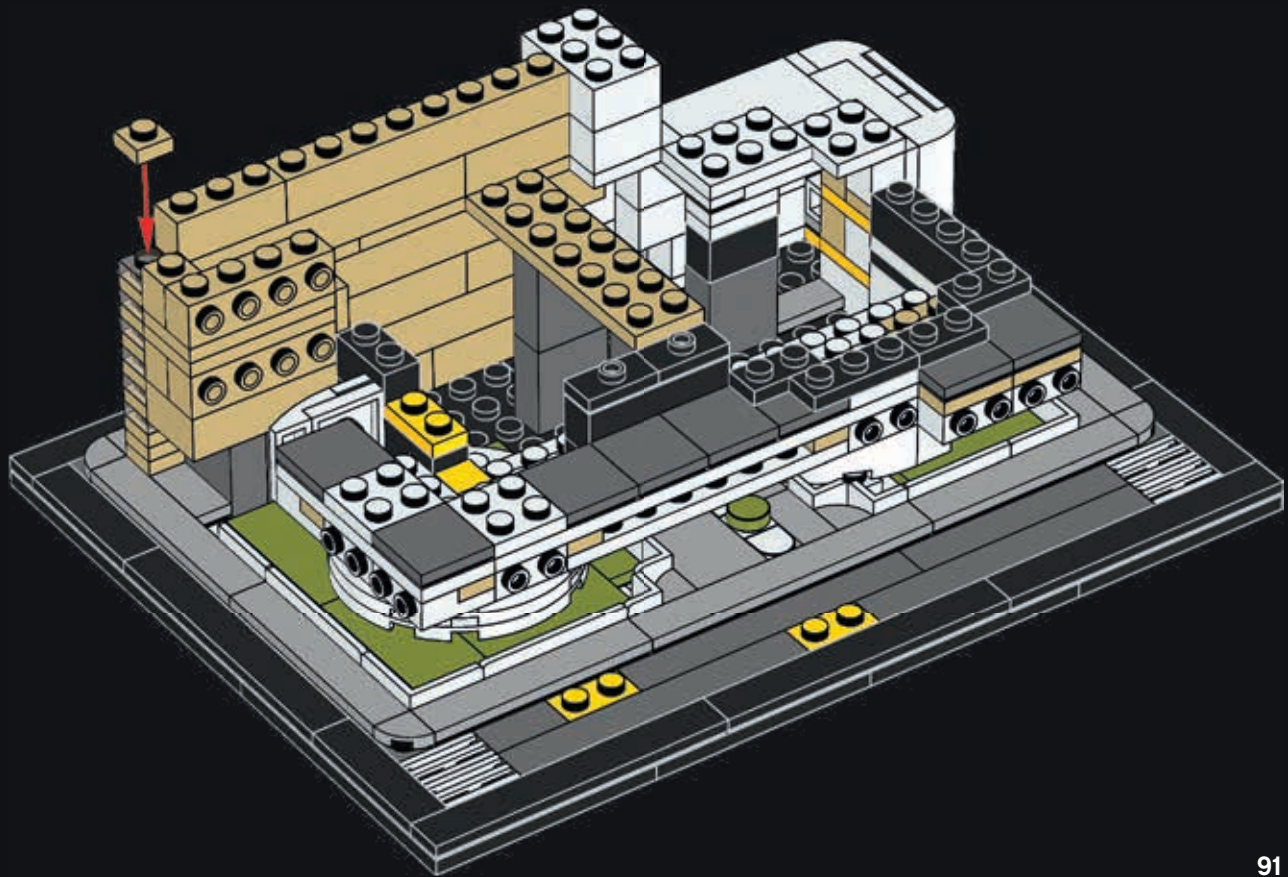



69

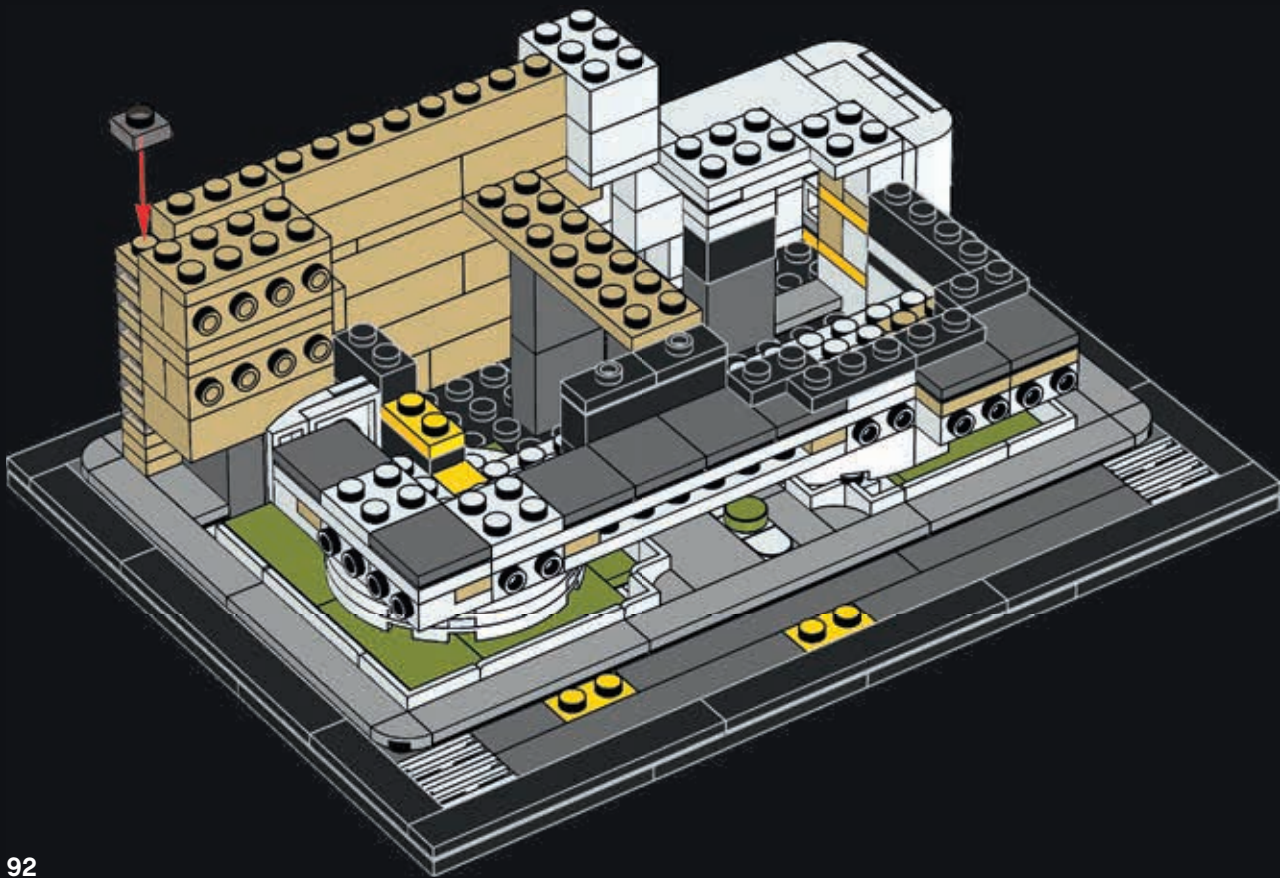



70

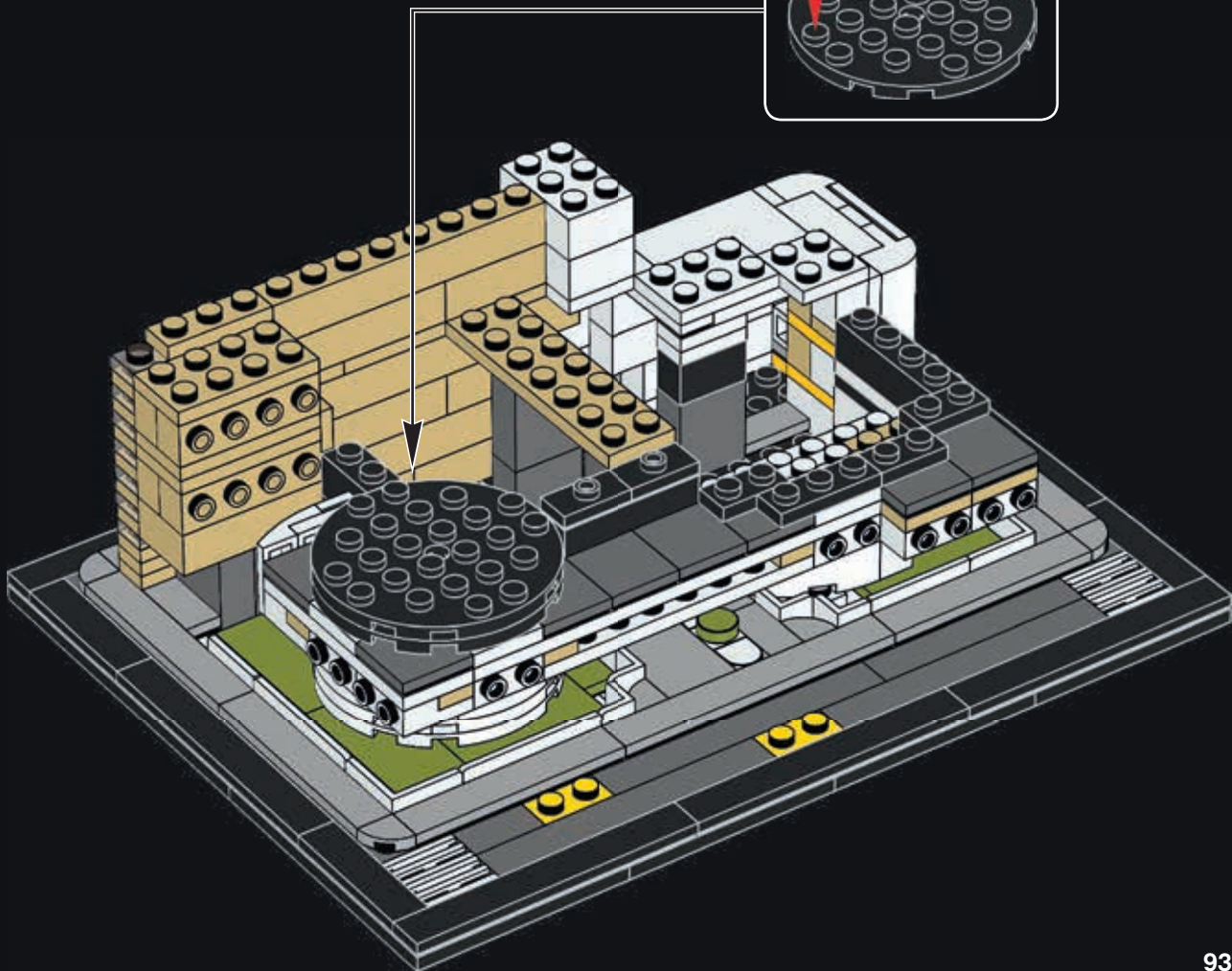
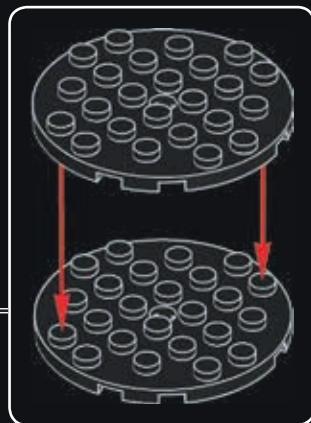



71

1



2

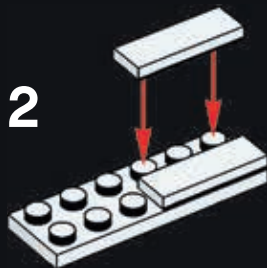

3

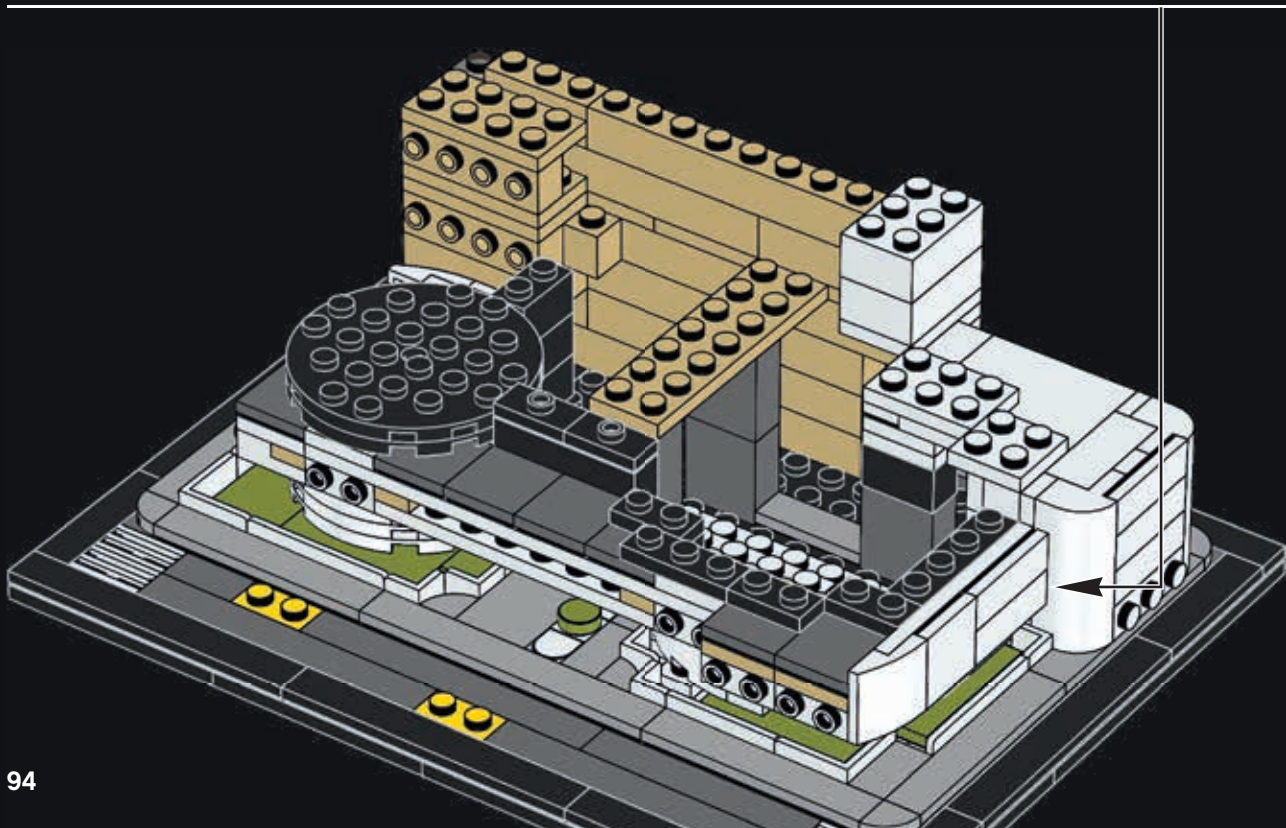
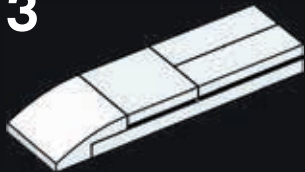



72

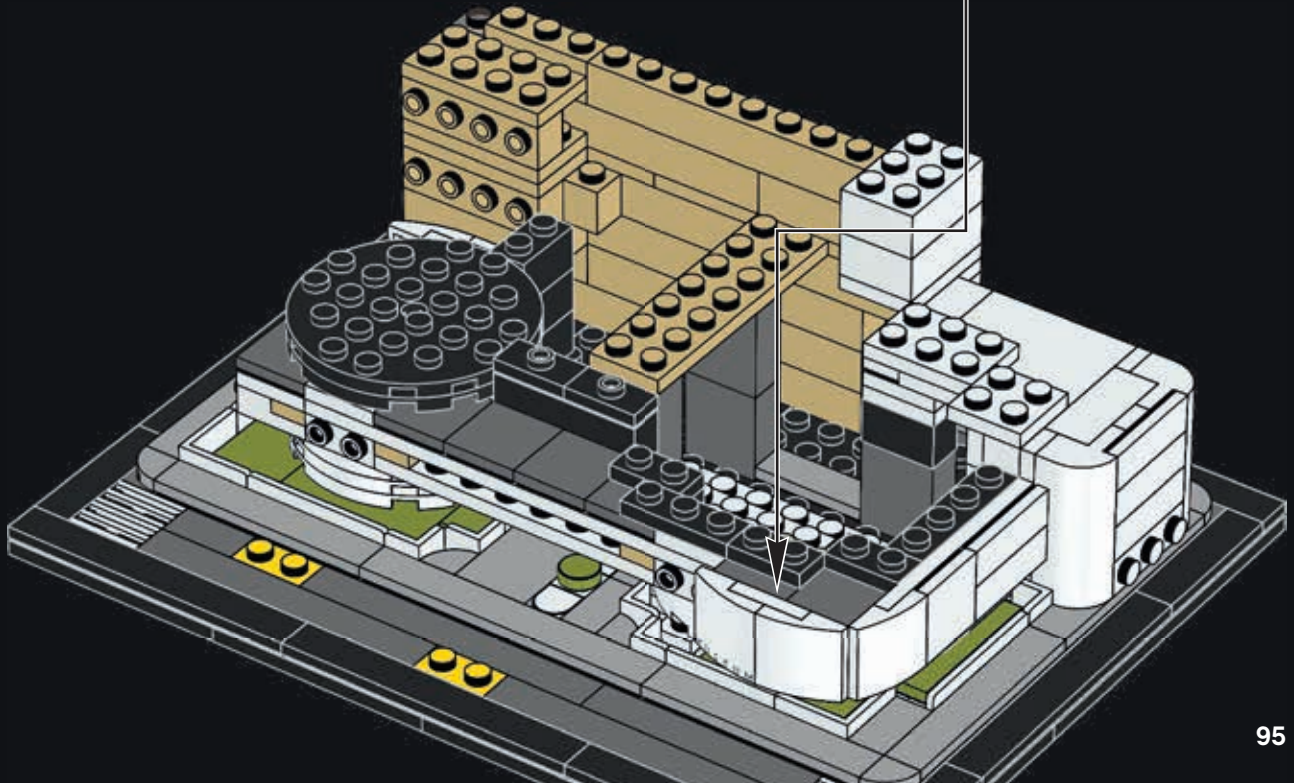
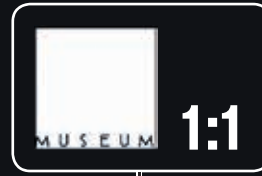

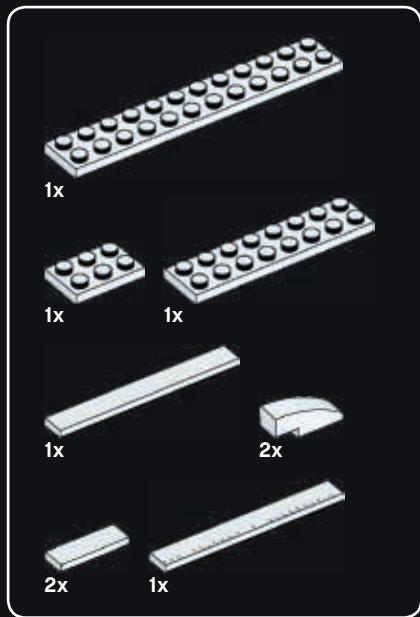

73

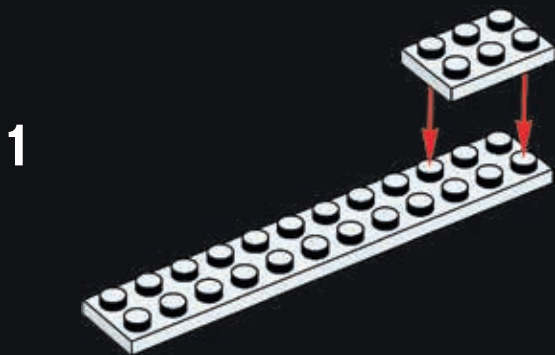

2



3

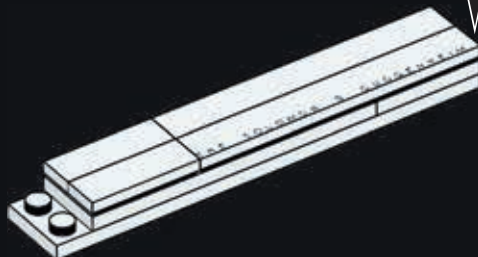

4

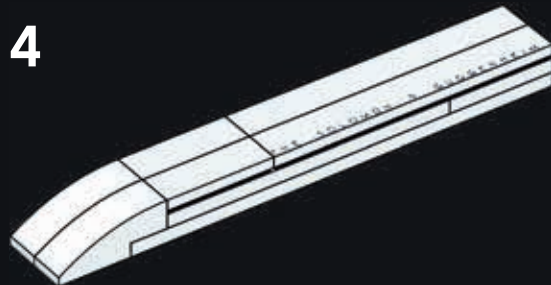

The seal on the floor of the Guggenheim entrance says,
"Let each man exercise the art he knows" – Aristophanes 422 B.C.

Le sceau sur le sol de l'entrée du Guggenheim porte l'inscription
« Laissez chaque homme exercer l'art qu'il connaît ». – Aristophane, 422 av. J.-C.

El sello que decora el piso del recibidor del Guggenheim dice:
« Que cada humano desempeñe el arte que domina ». – Aristófanes, 422 A.C.

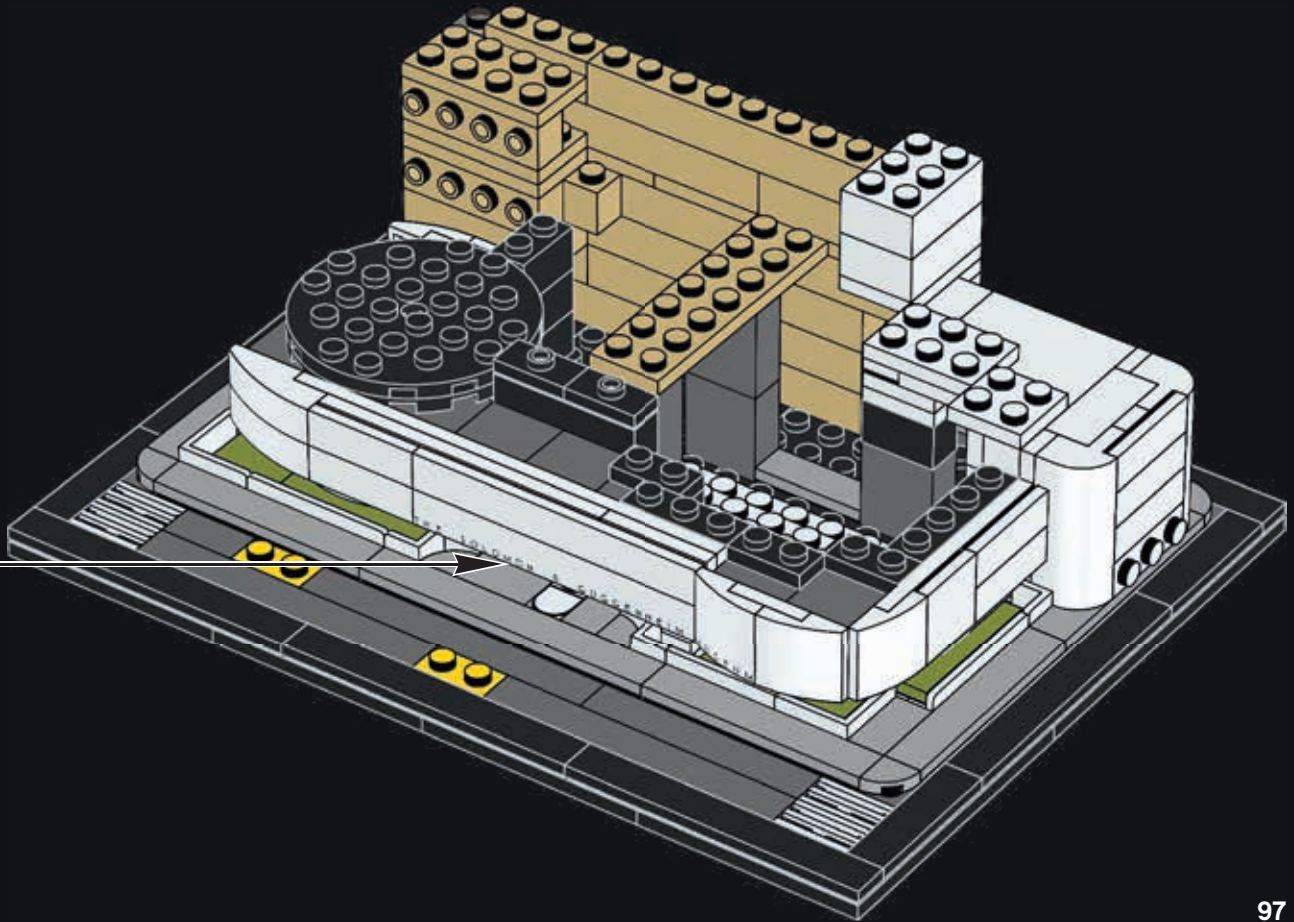



74

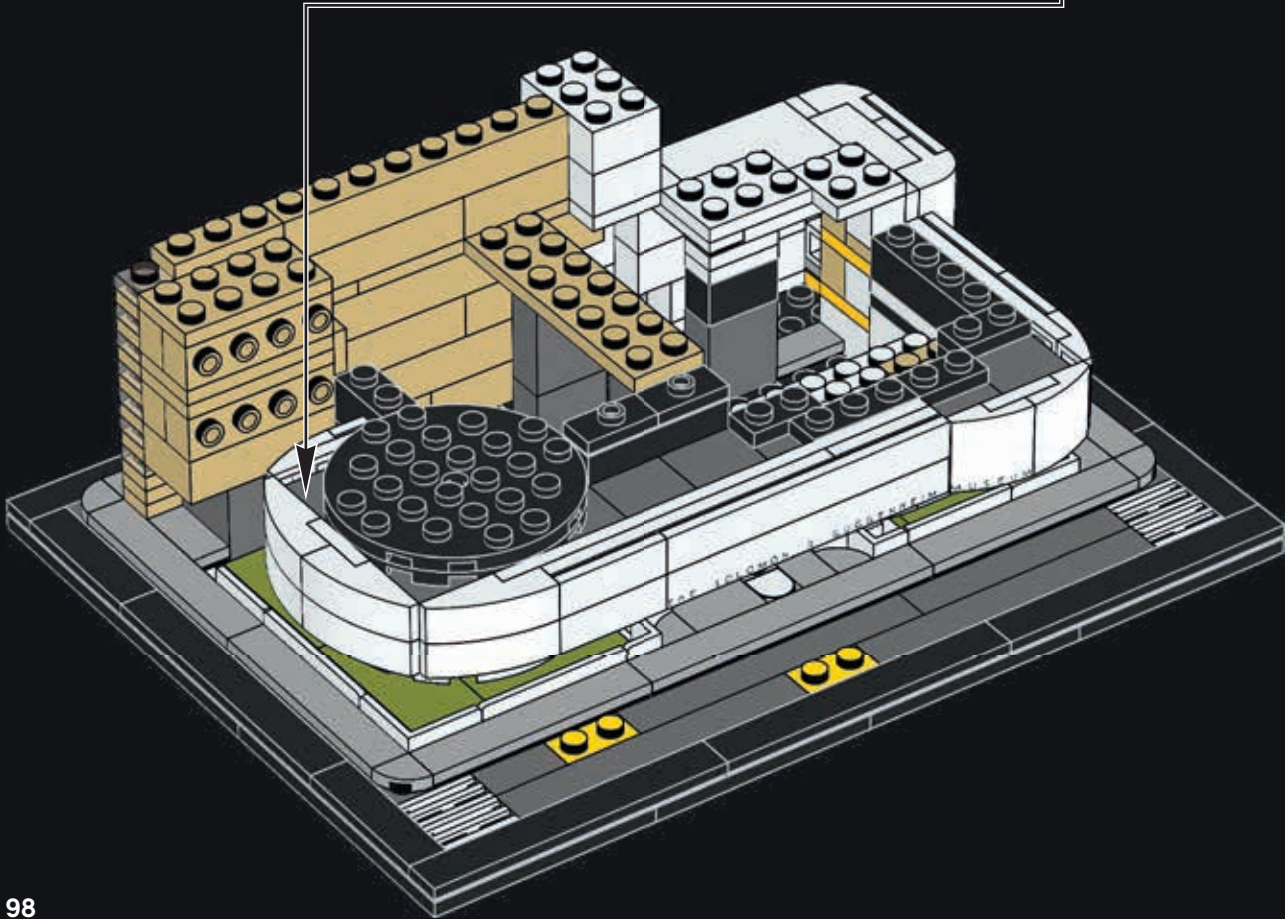
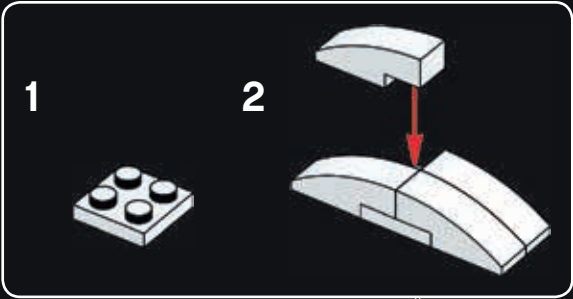



75

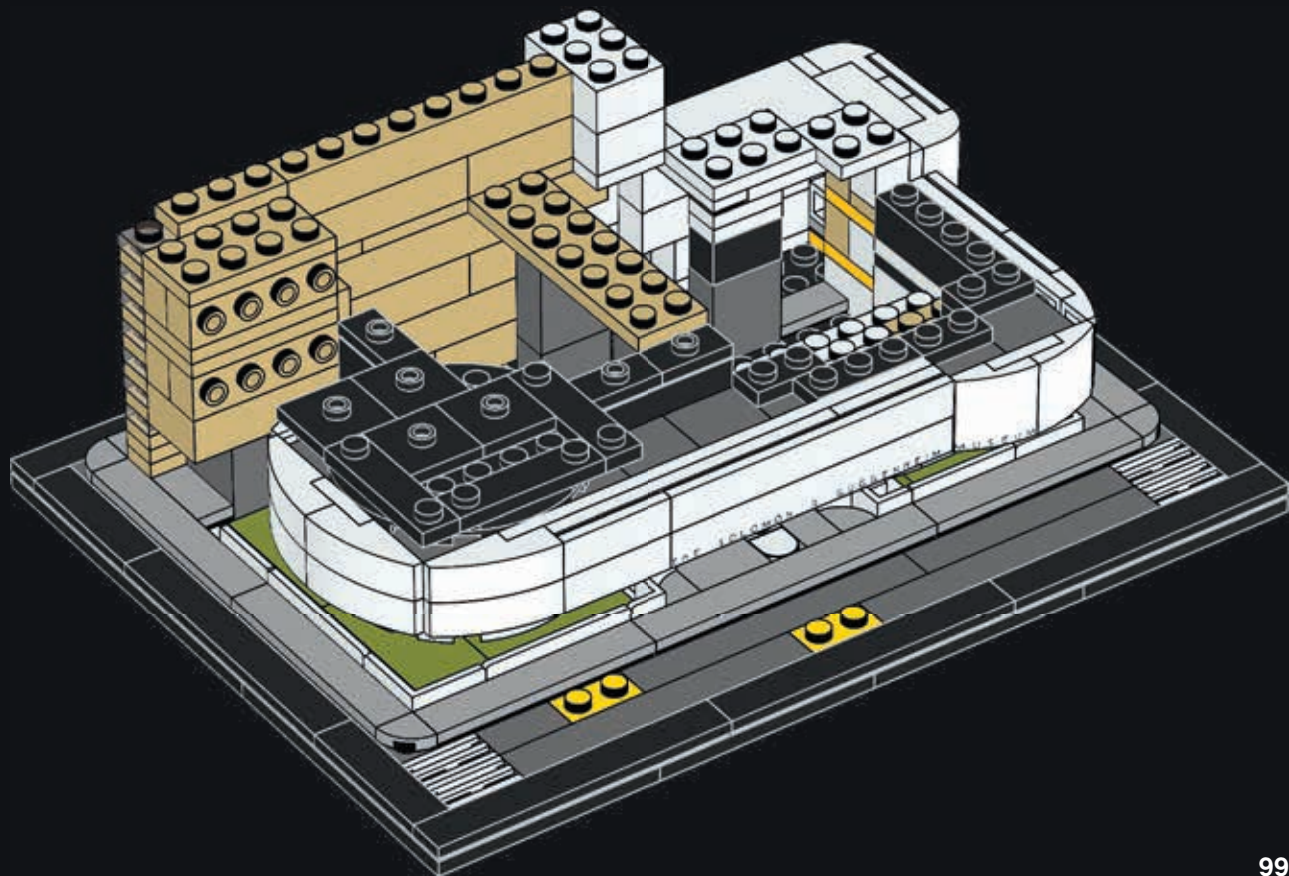



1x

76

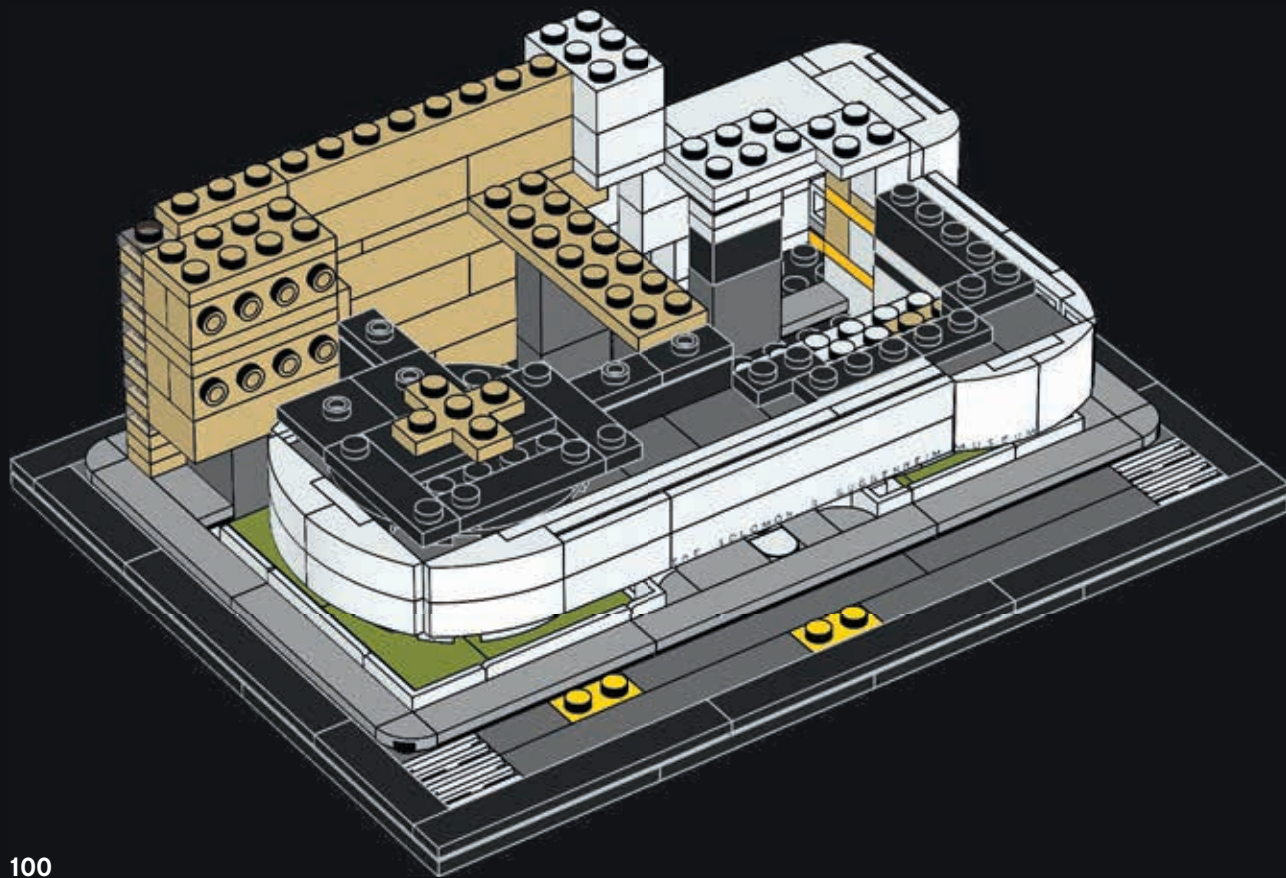



77

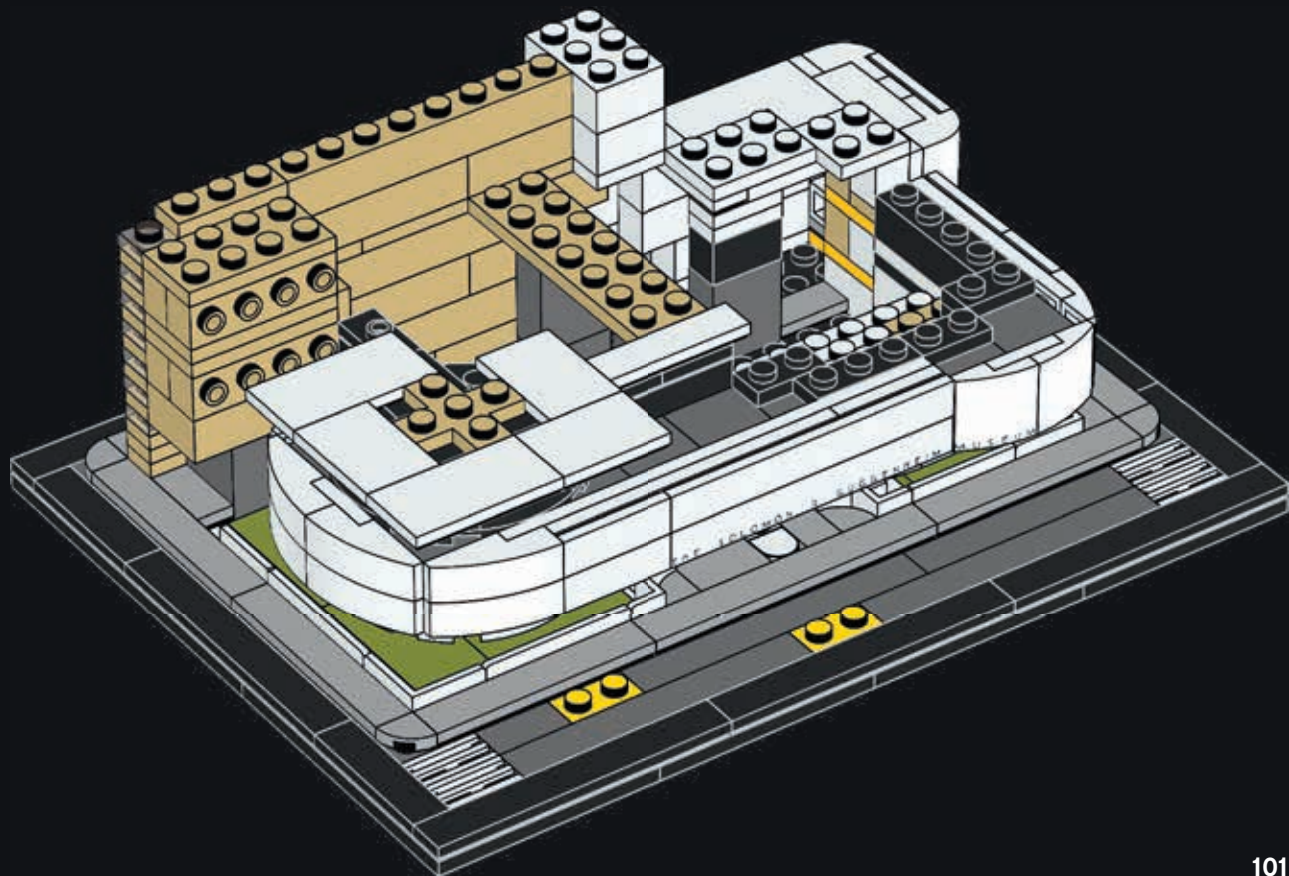



1x

78

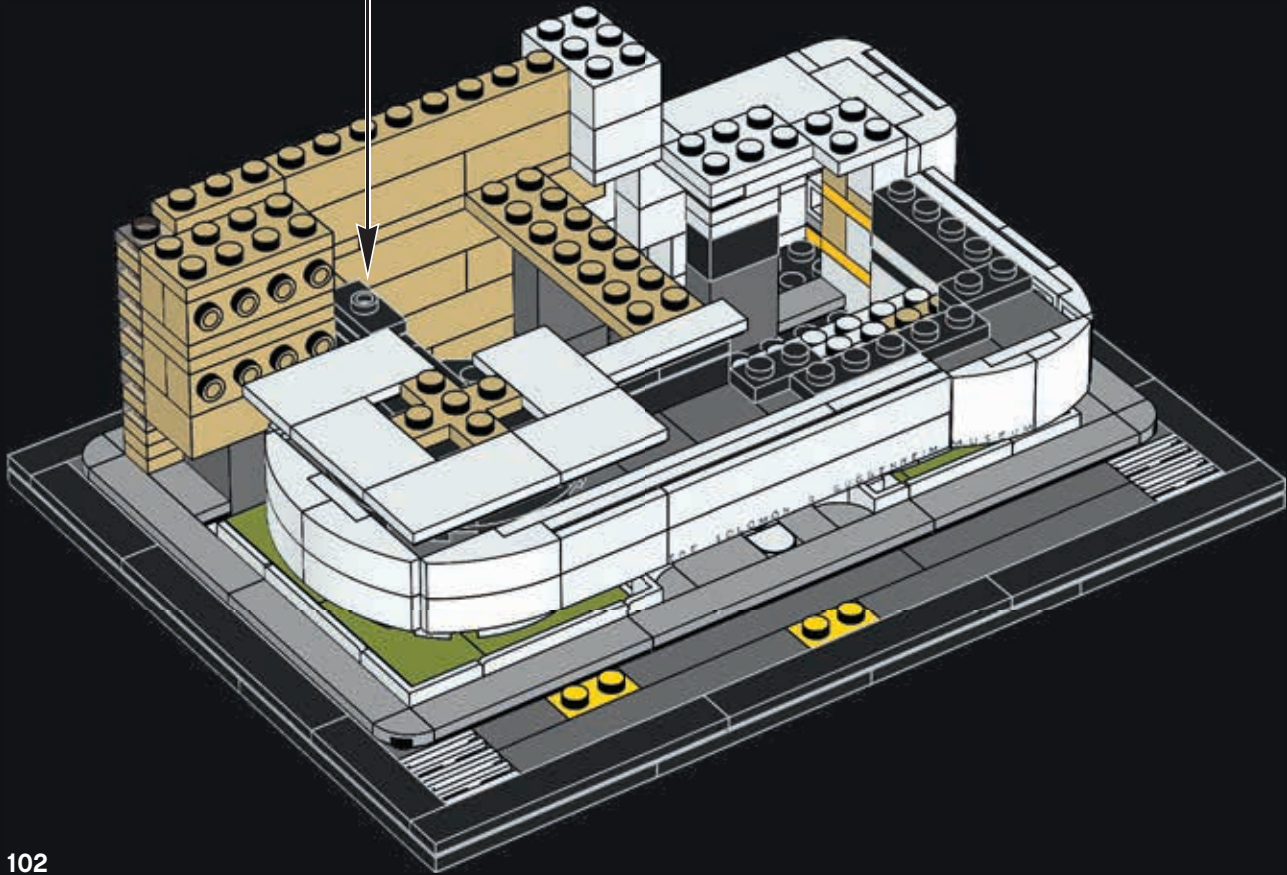



79

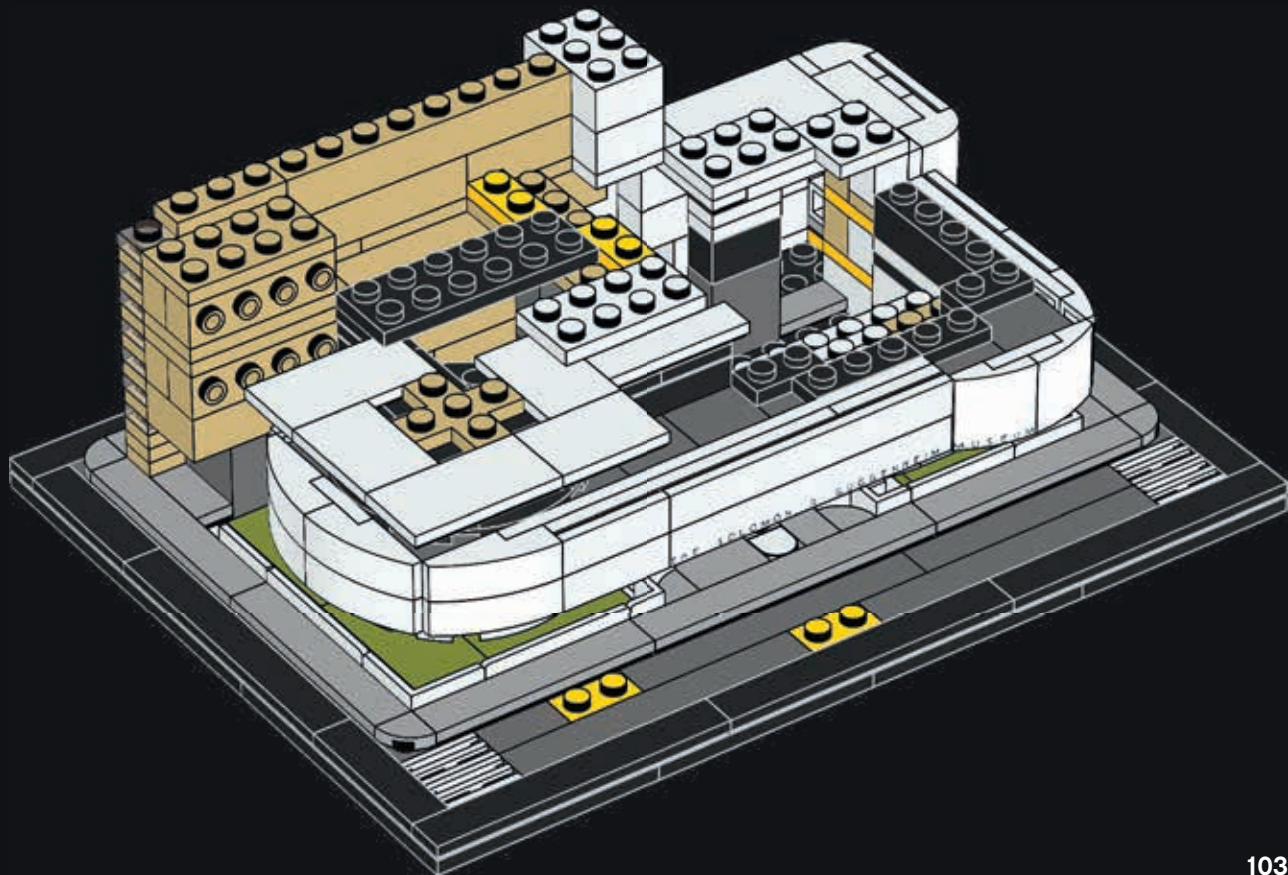

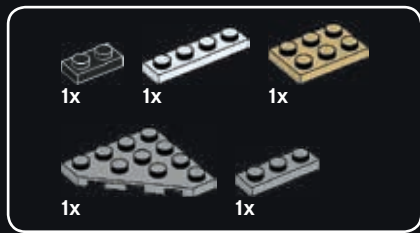

80

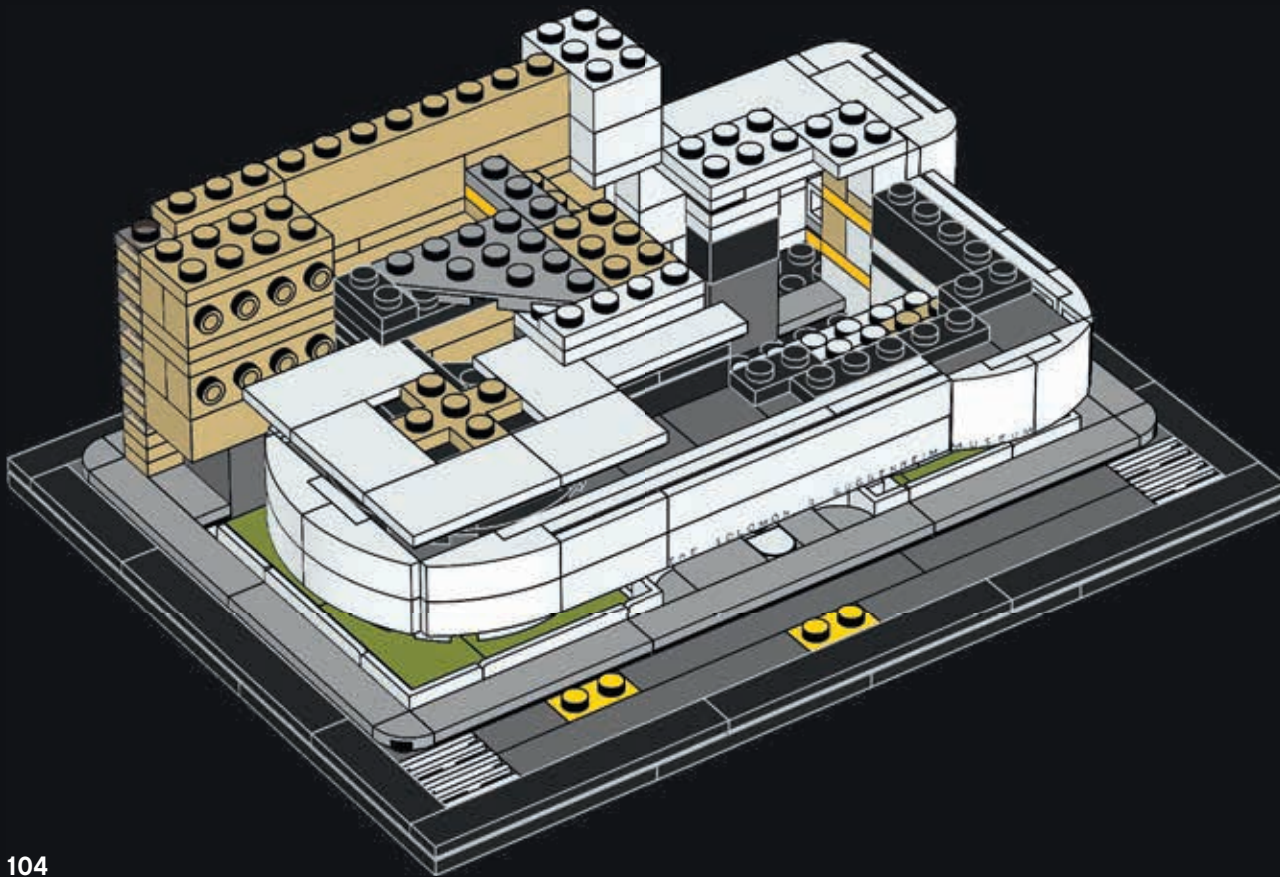



81

The Guggenheim building is made of 700 tons (635,000 kg) of steel and 7,000 cubic feet (198.2 cubic meters) of poured concrete.

Le bâtiment du Guggenheim est fabriqué avec 635 000 kg d'acier et 198,2 mètres cubes de béton coulé.

El edificio del Guggenheim contiene 635.000 kg de acero y 198,2 m³ de concreto vertido.

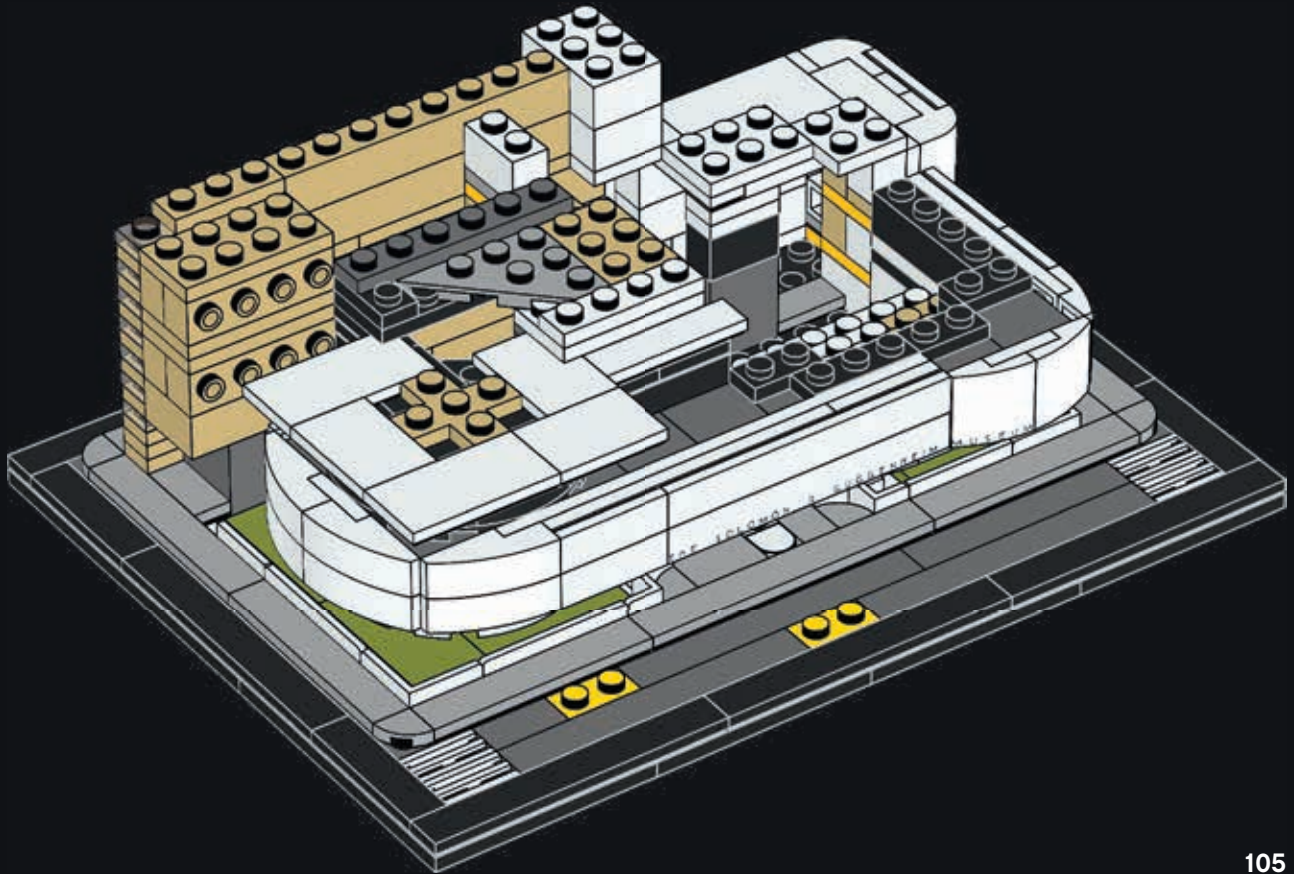



82

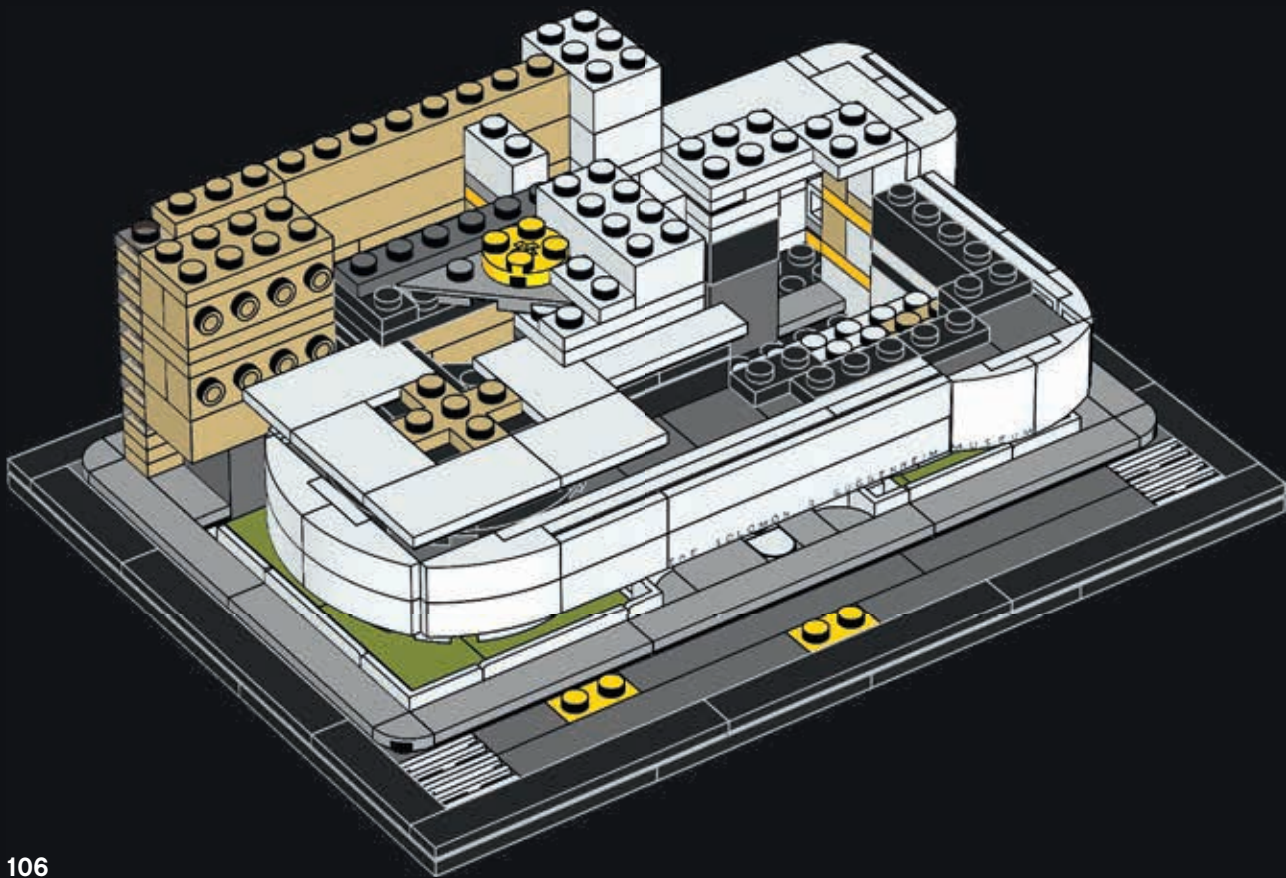



83

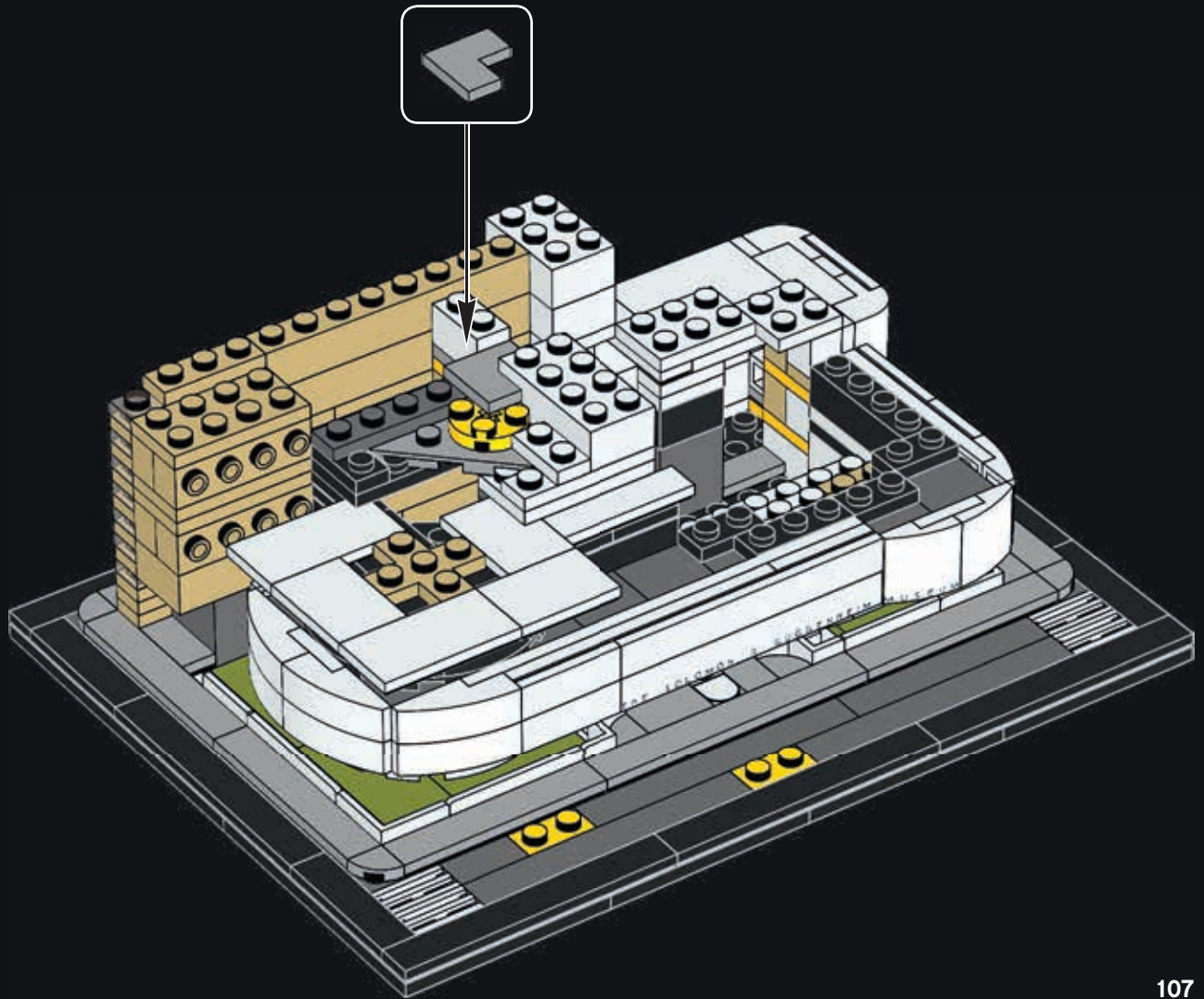

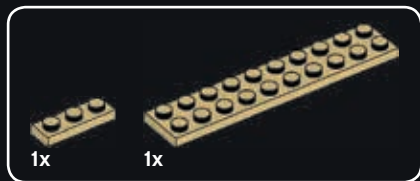

84

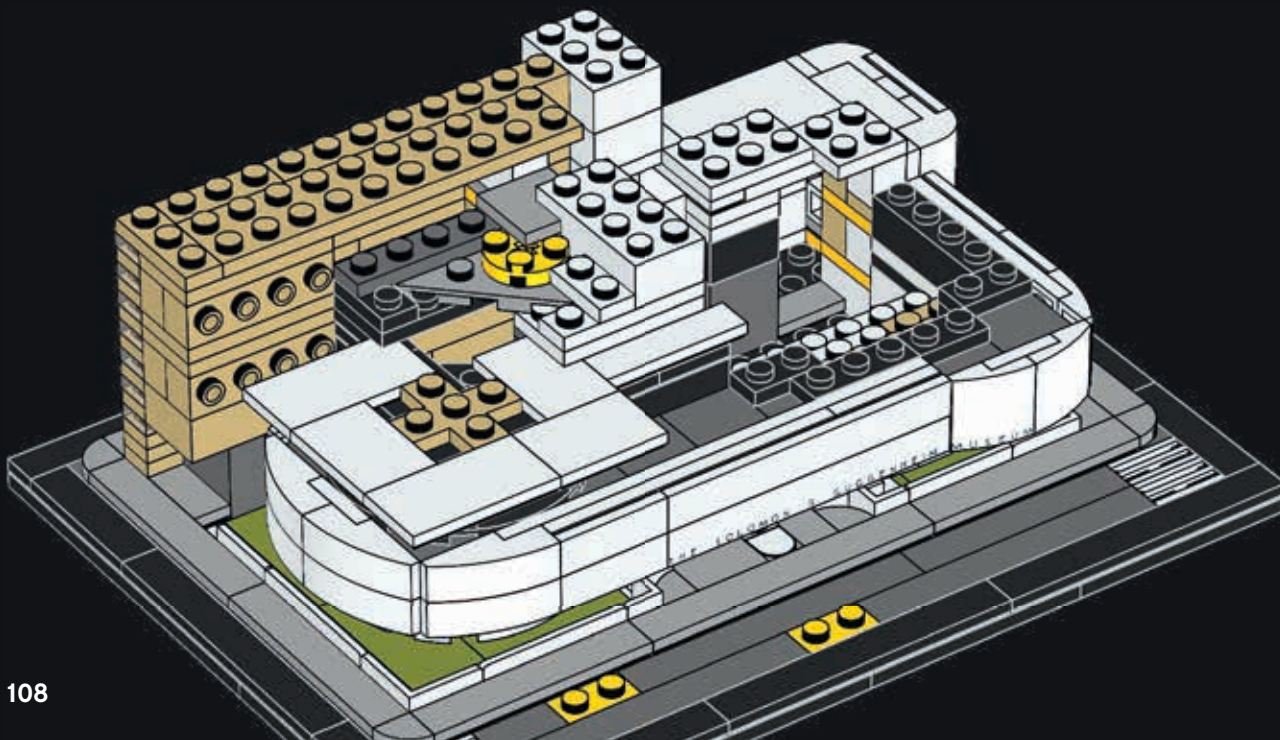



85

1



2



3



4

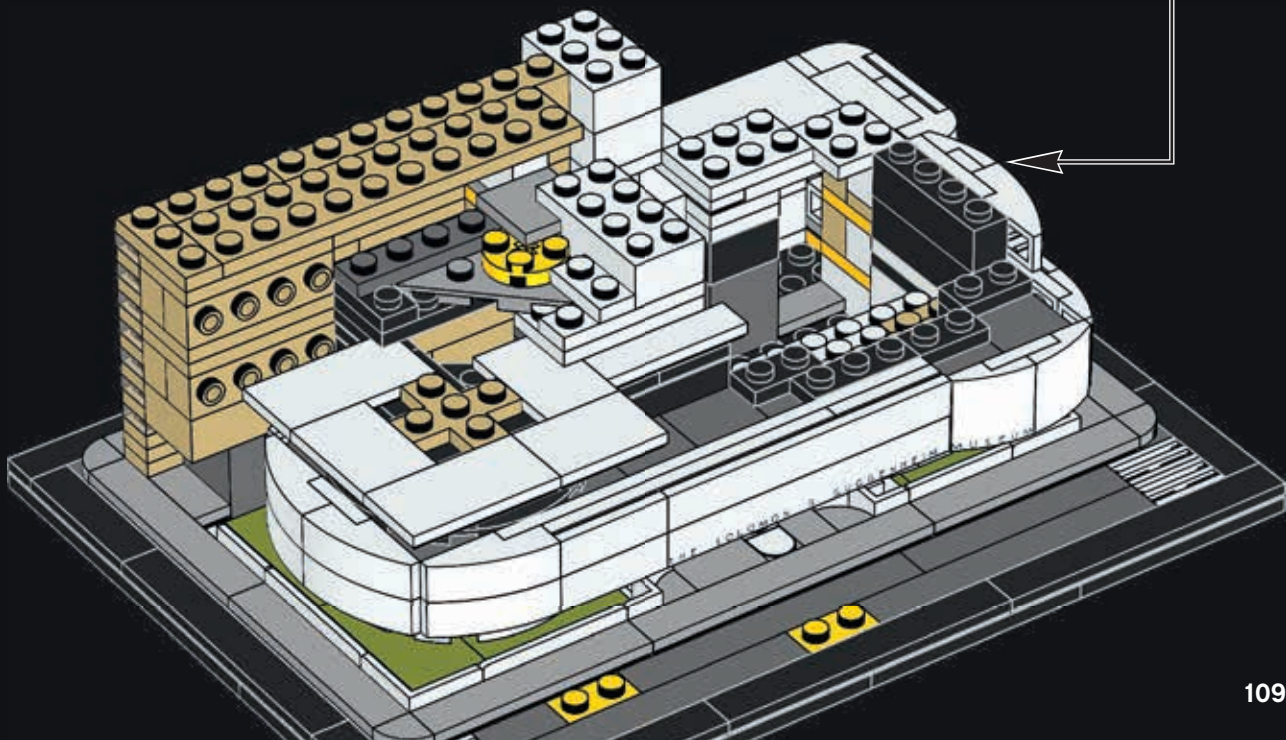
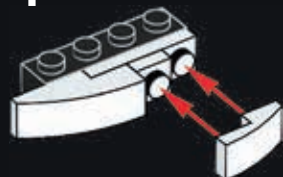



86

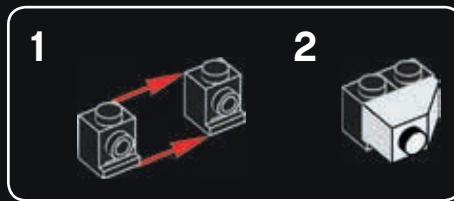

1



2



3



4

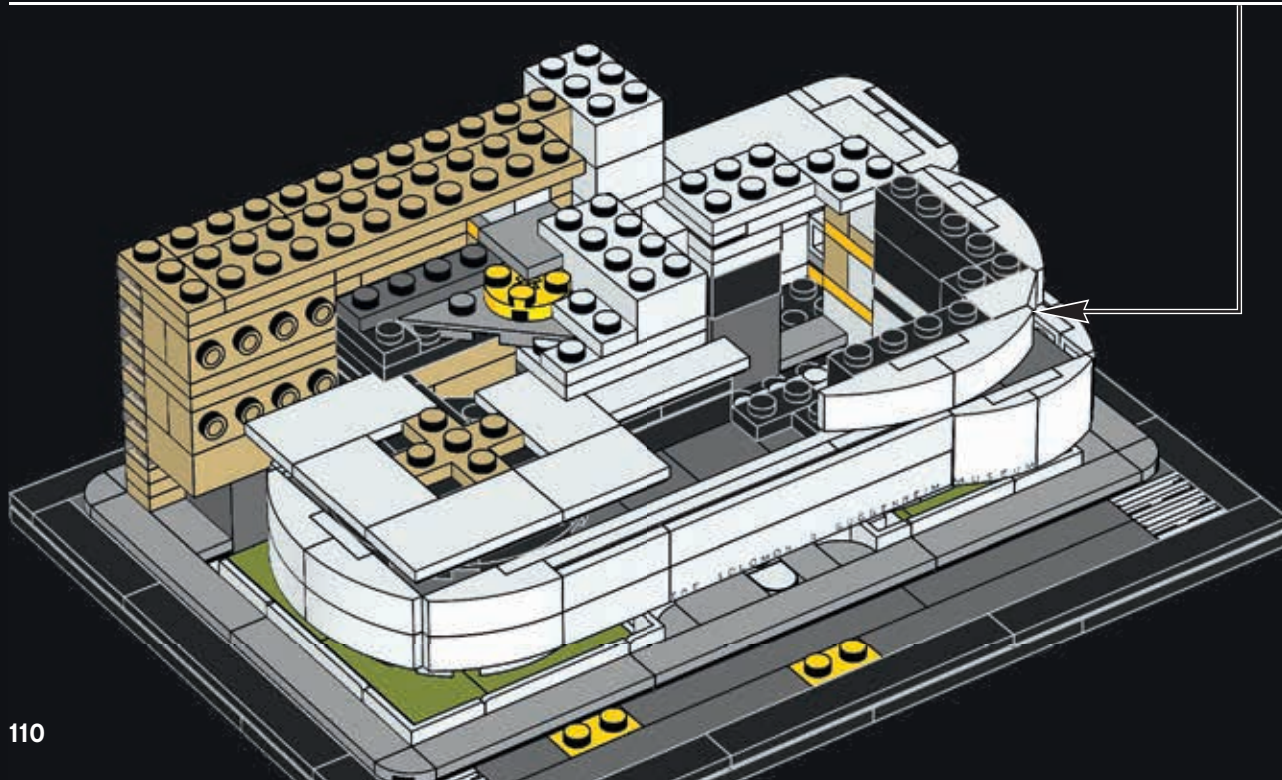
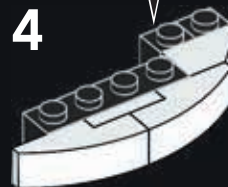



1x

87

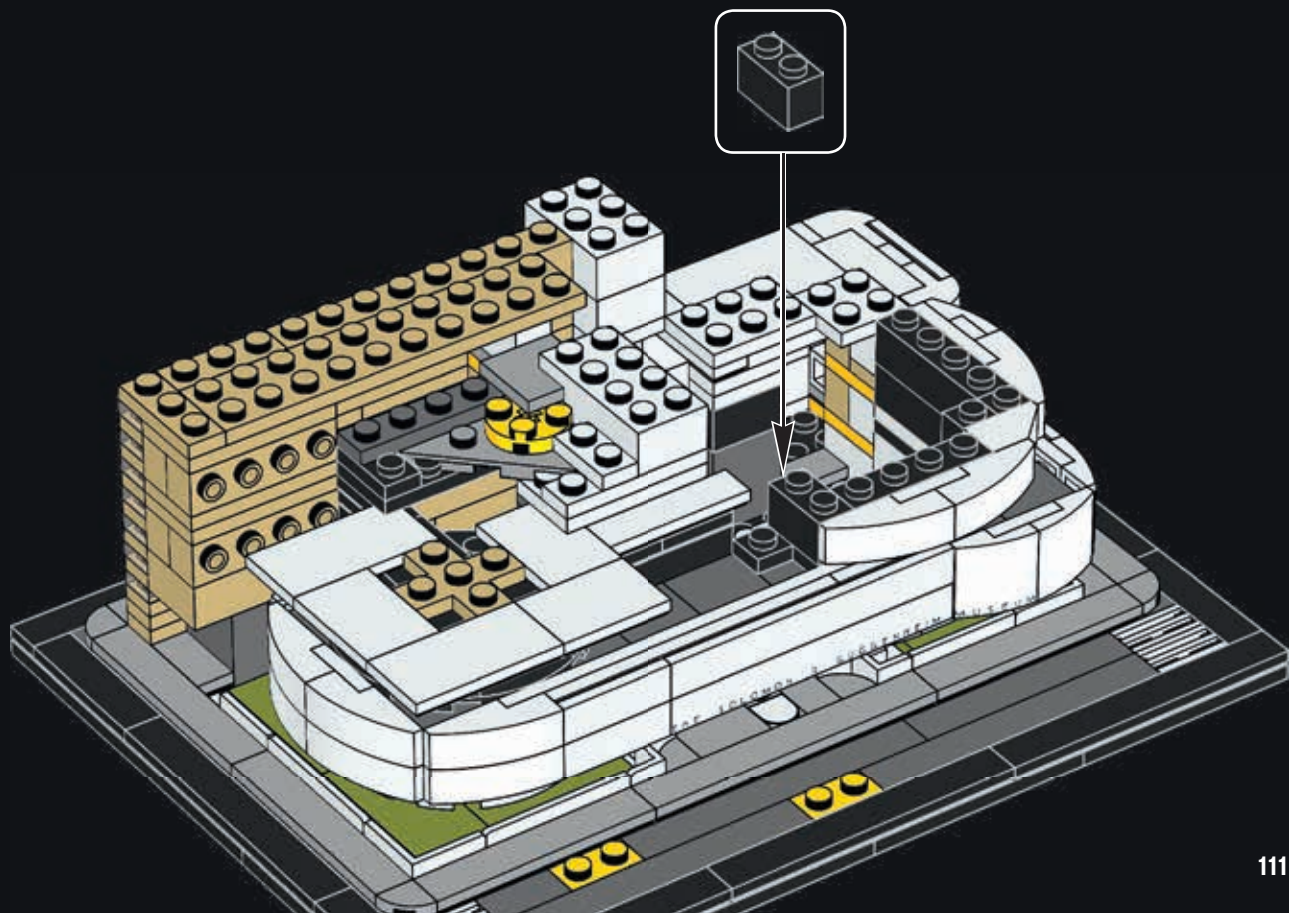

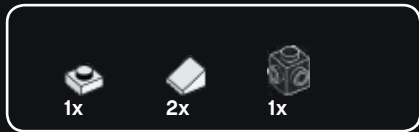

88

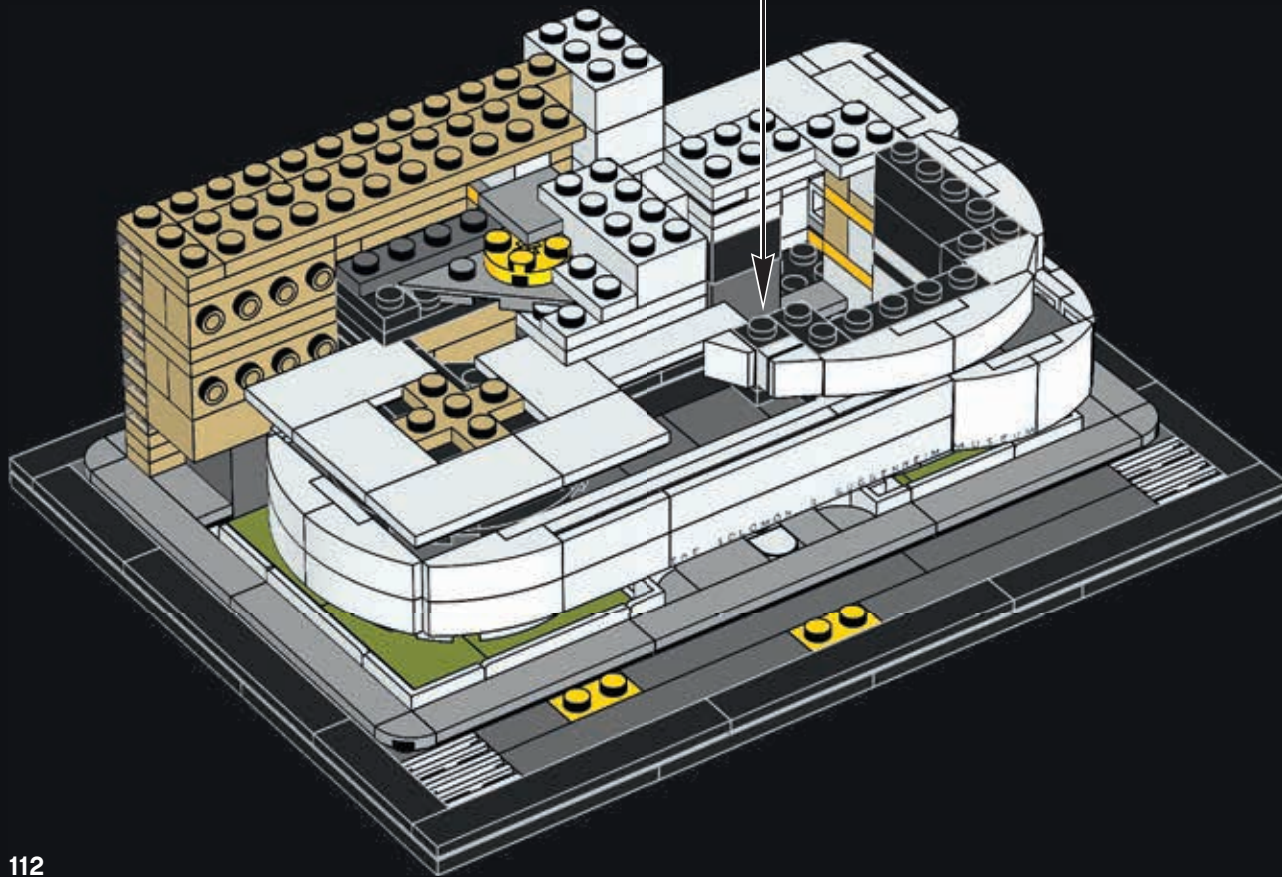



2x



1x



3x



1x

89

1

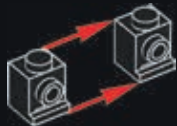

2



3



4



5

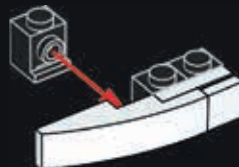

6



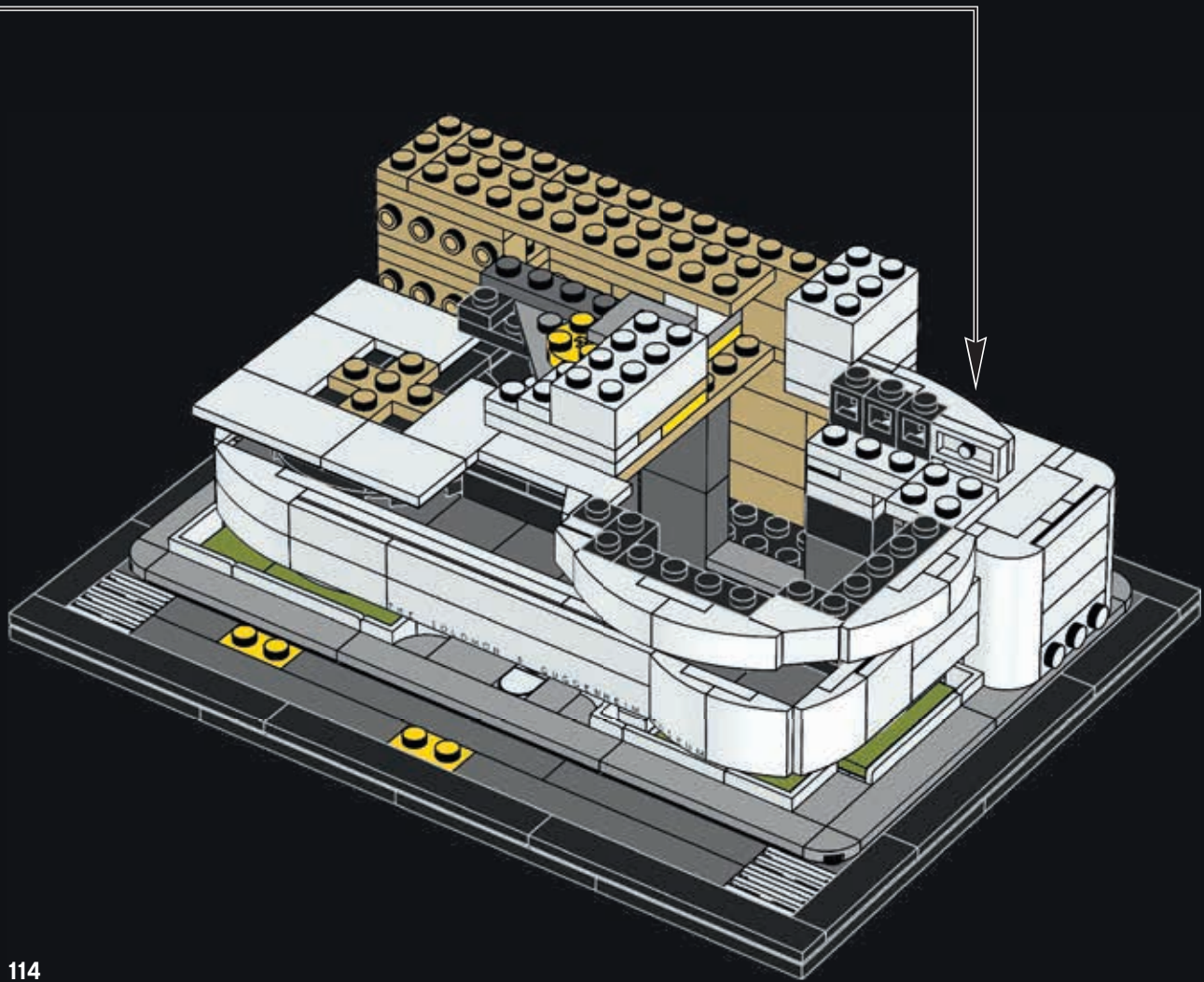



2x

90

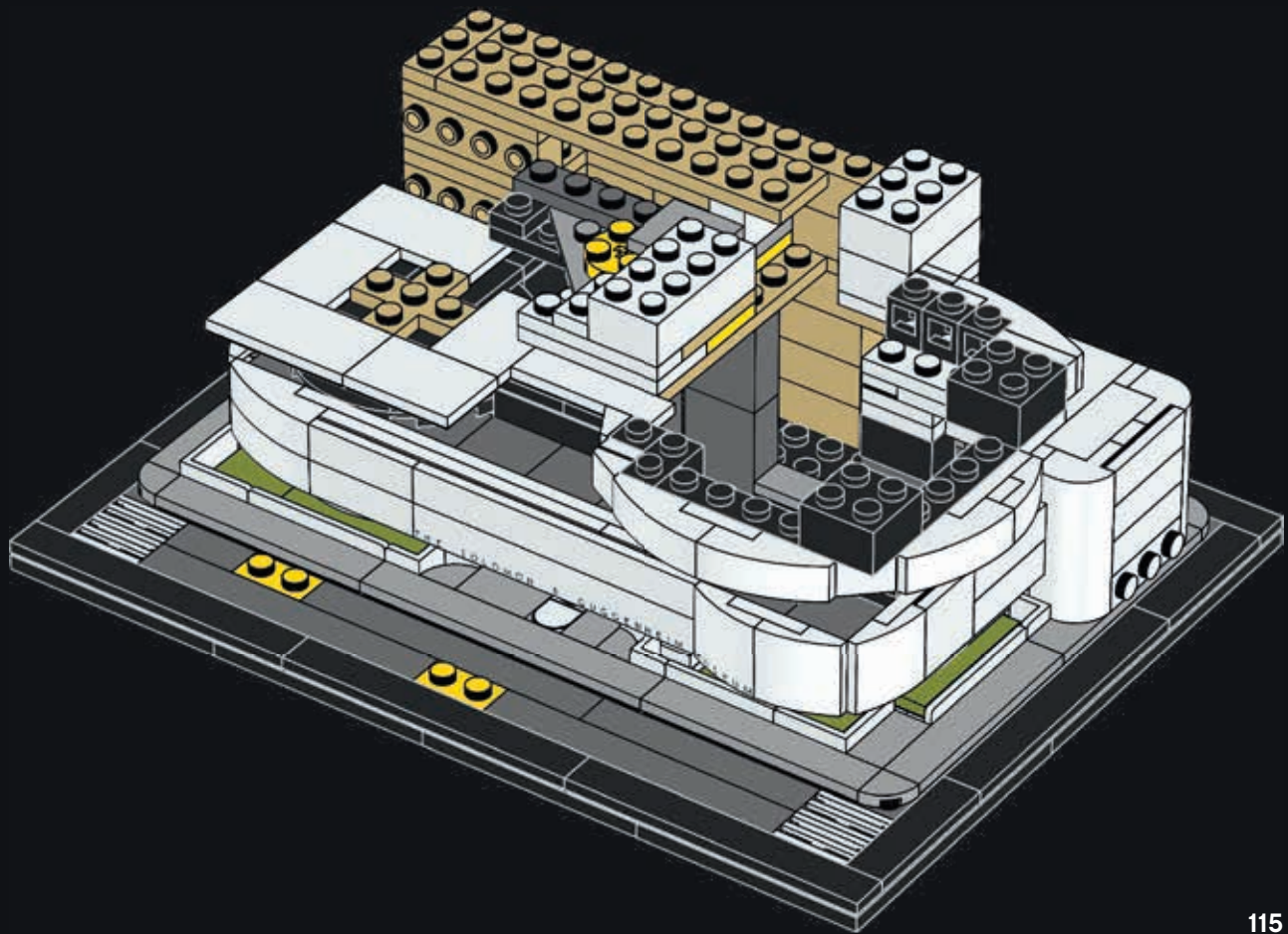



2x



2x



4x



4x



4x



2x



4x

91

1



2

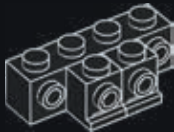

3

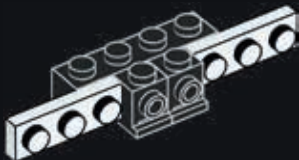

4

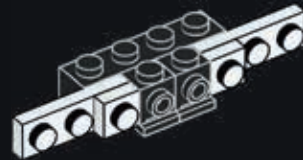

5



6

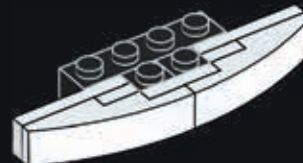

2x

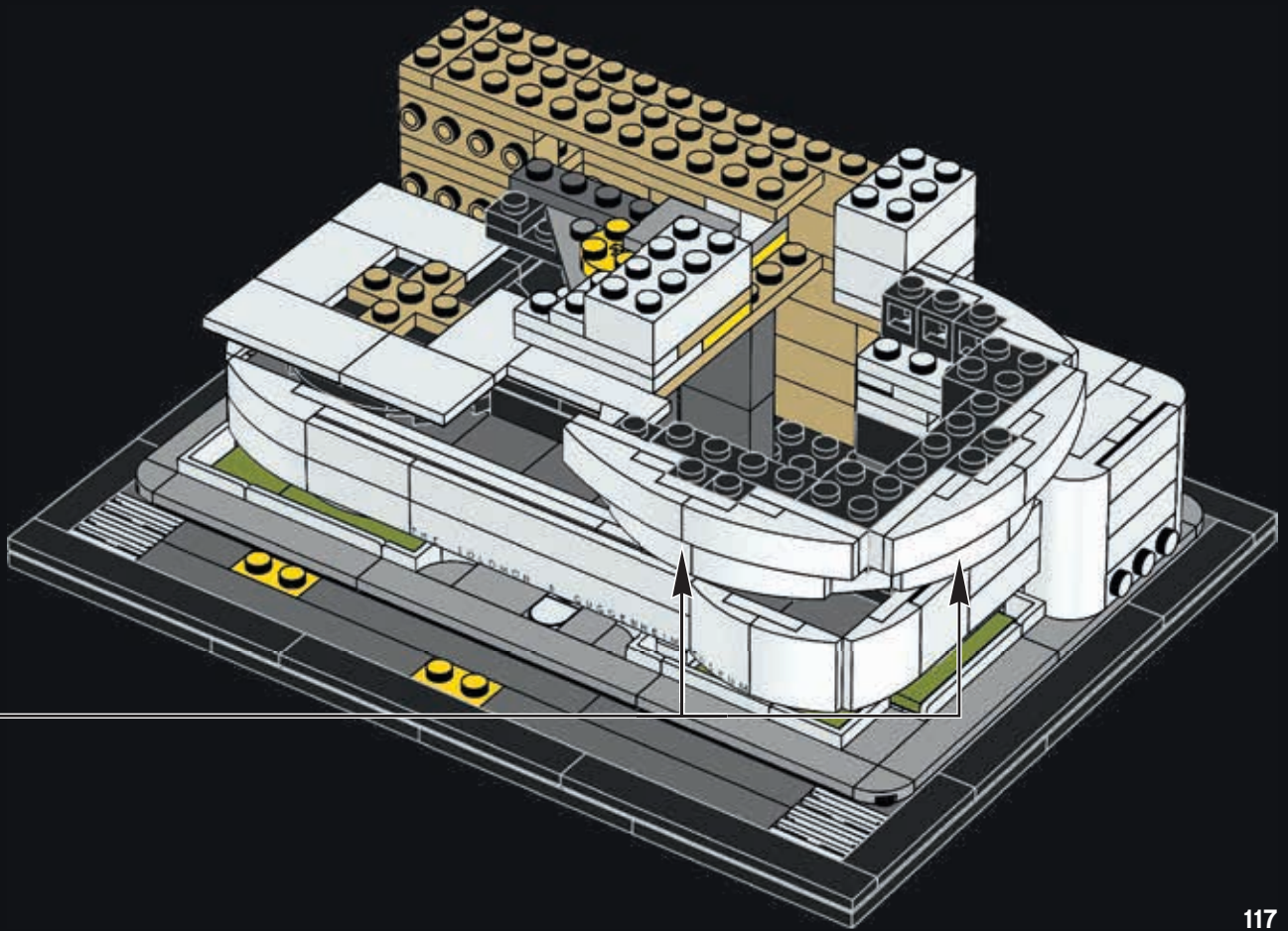



1x

92

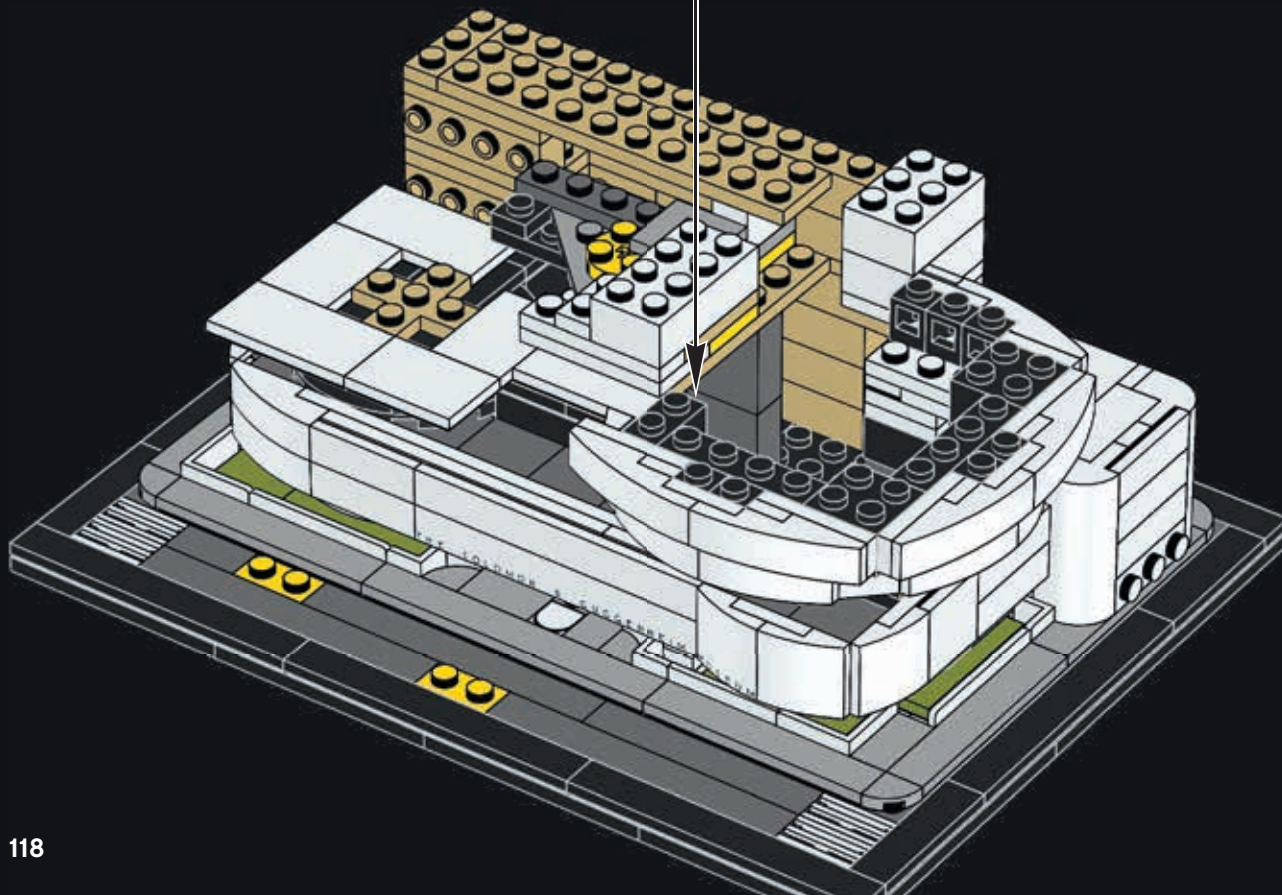



93

1



2



3



4

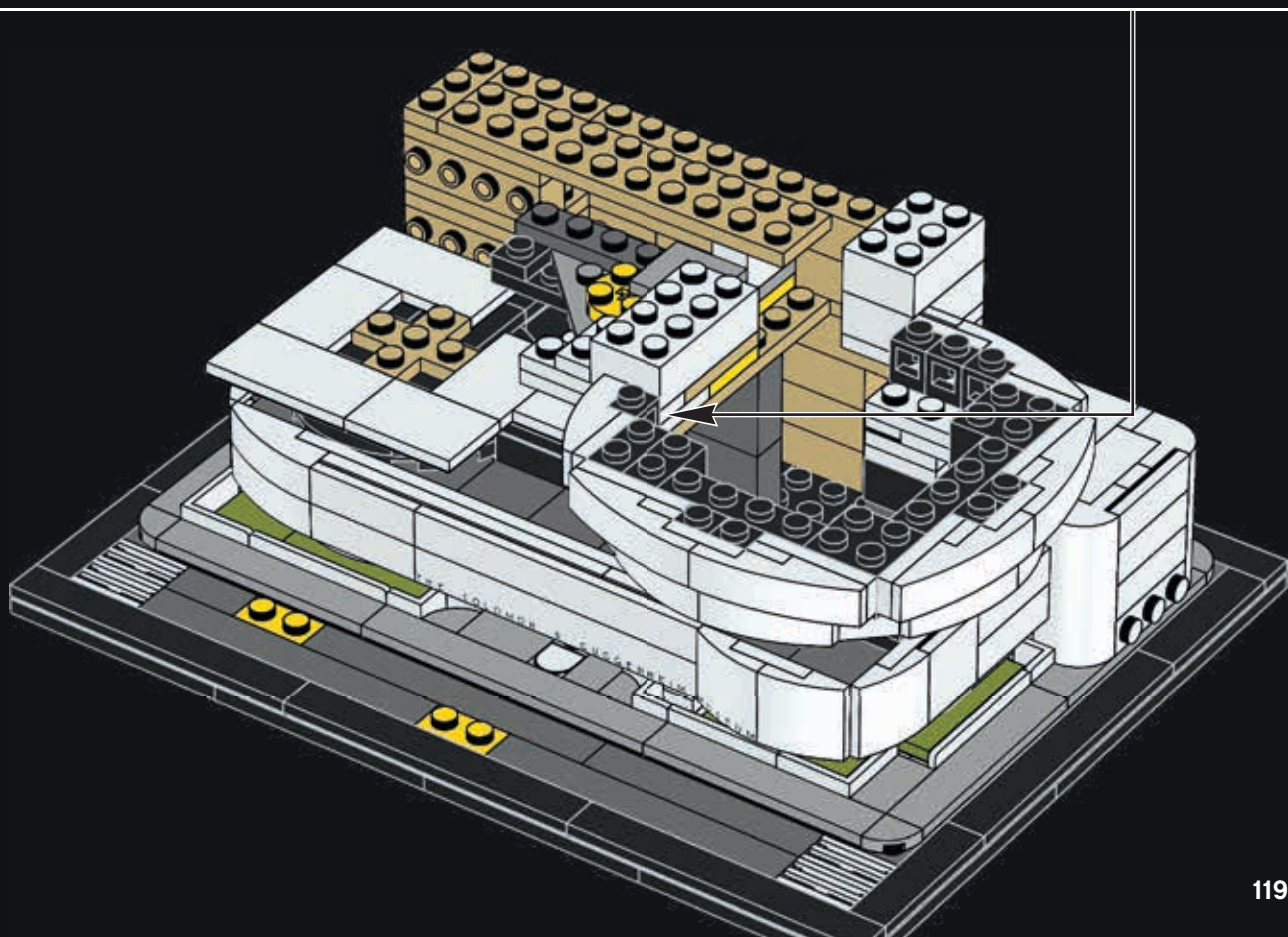
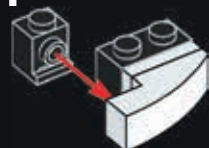



94

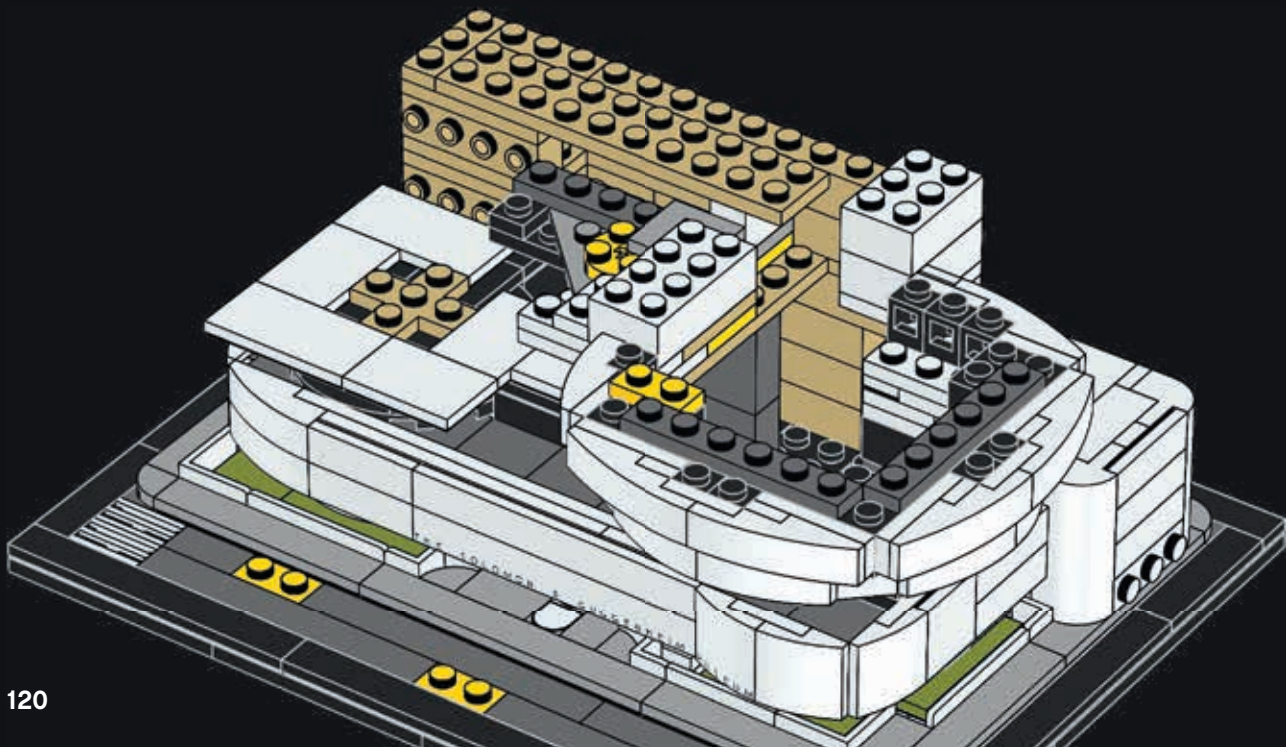

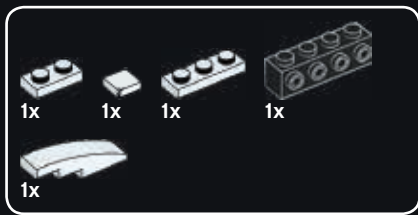

95

1

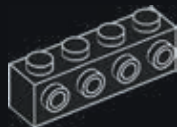

2



3



4

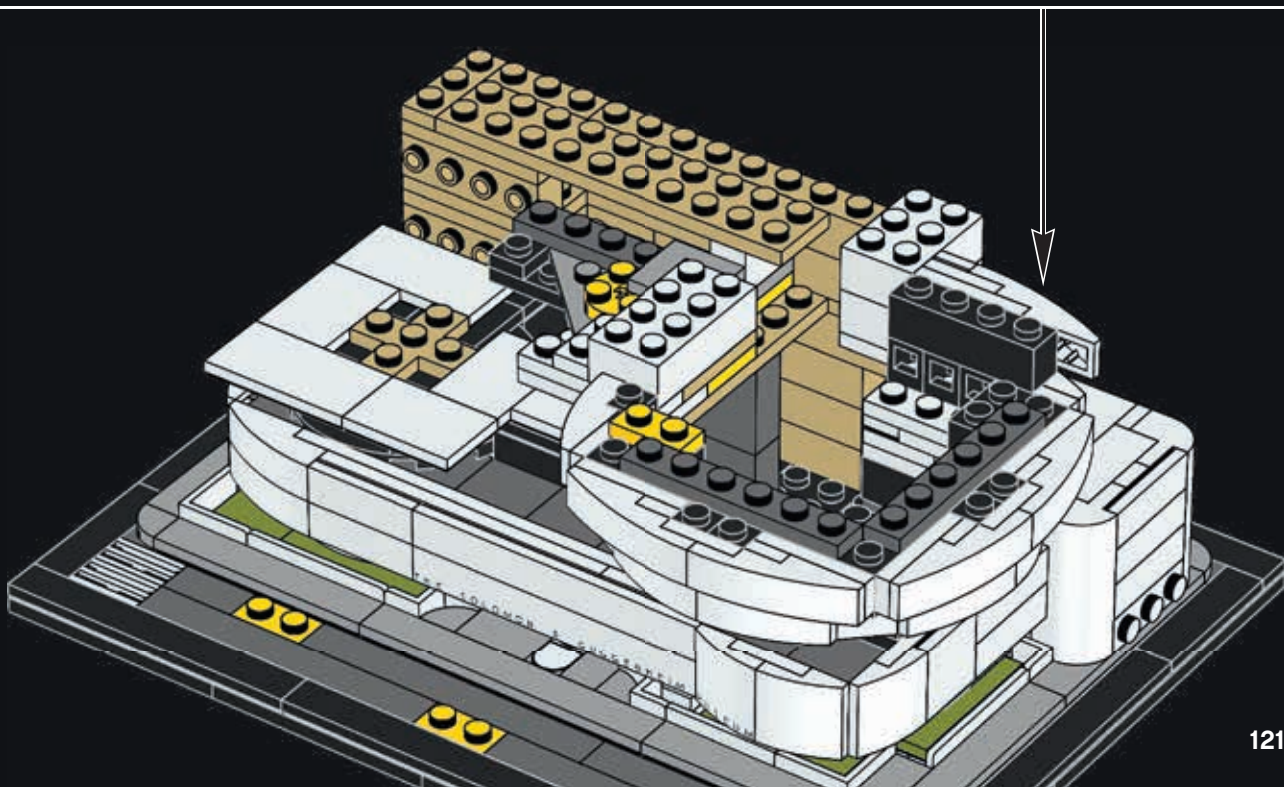



2x



1x

96

1

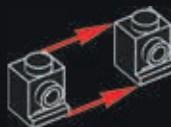

2

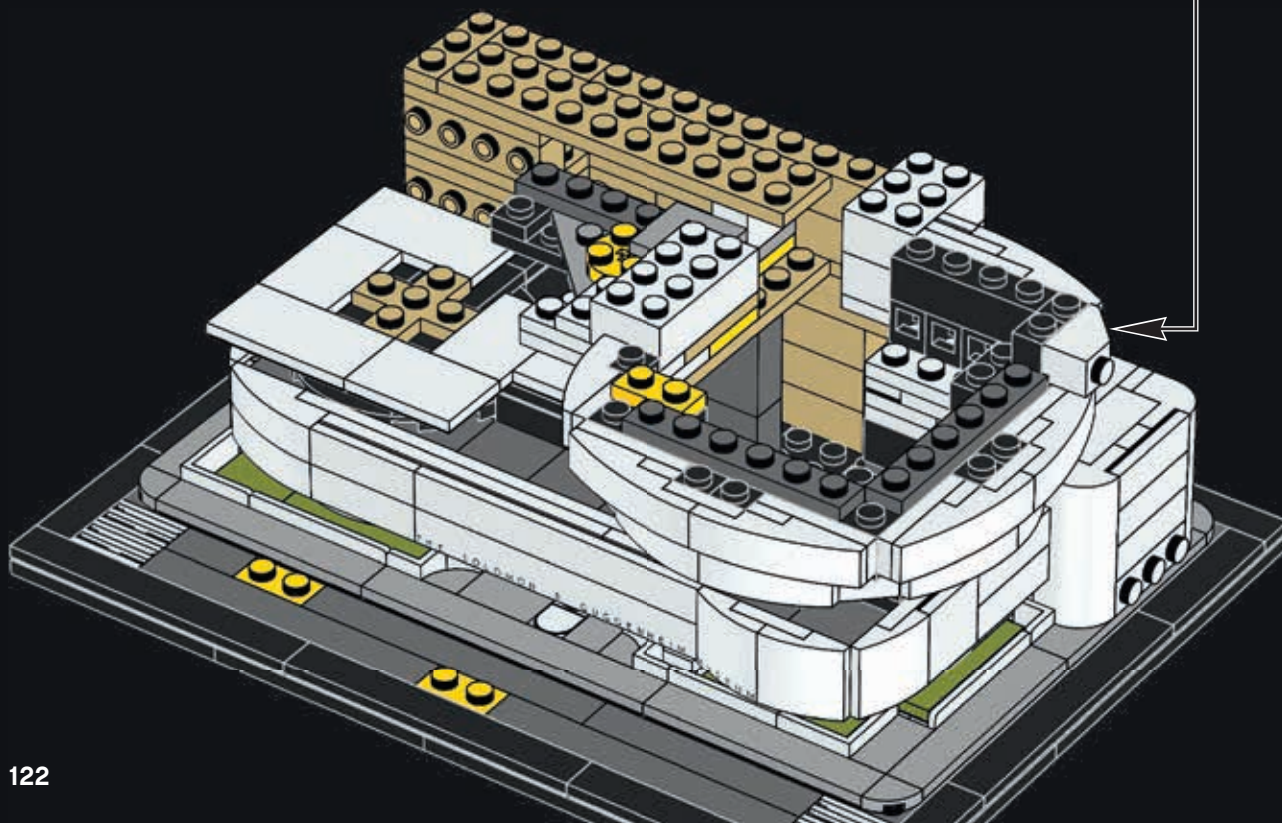

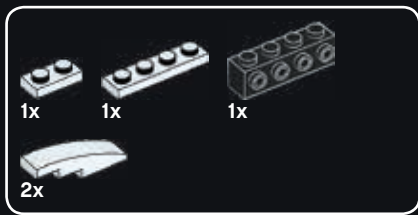

97

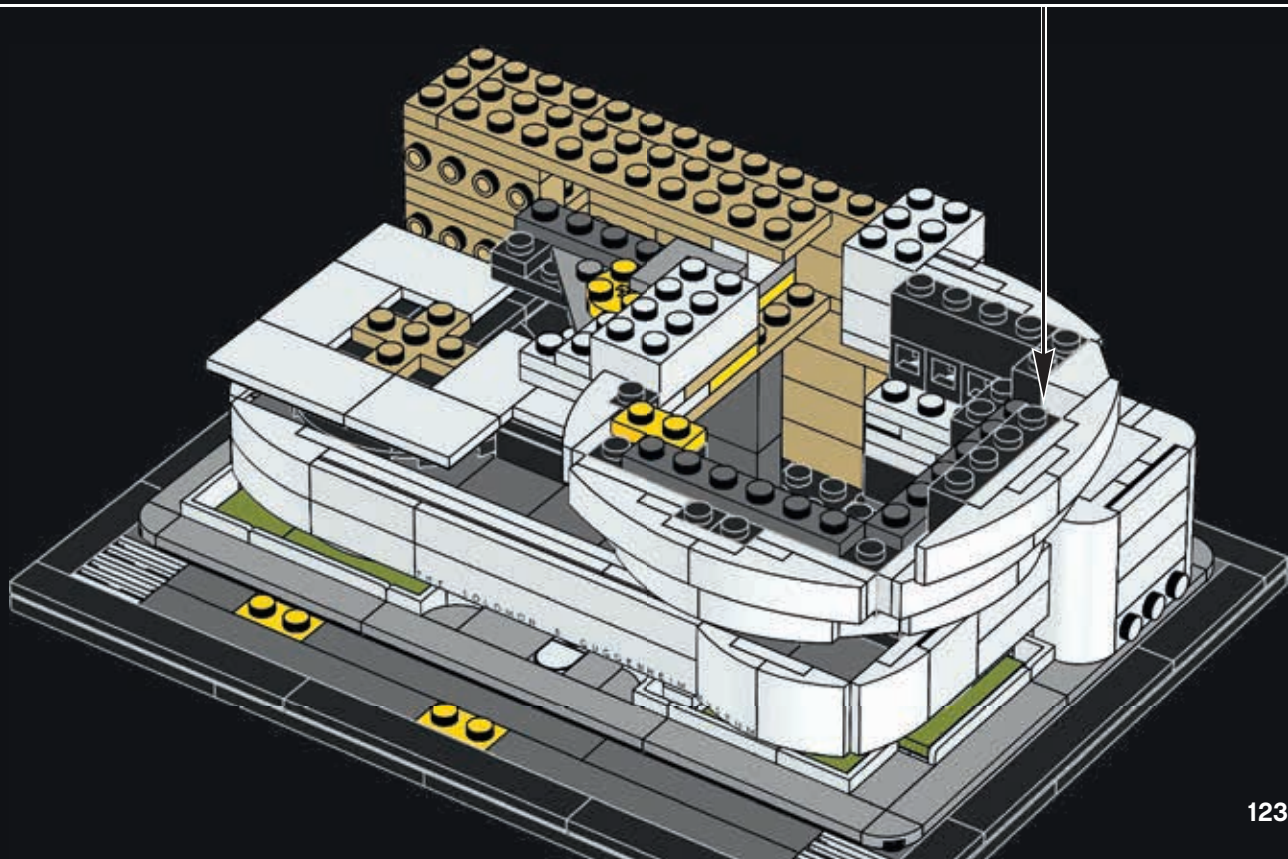



2x



1x

98

1



2

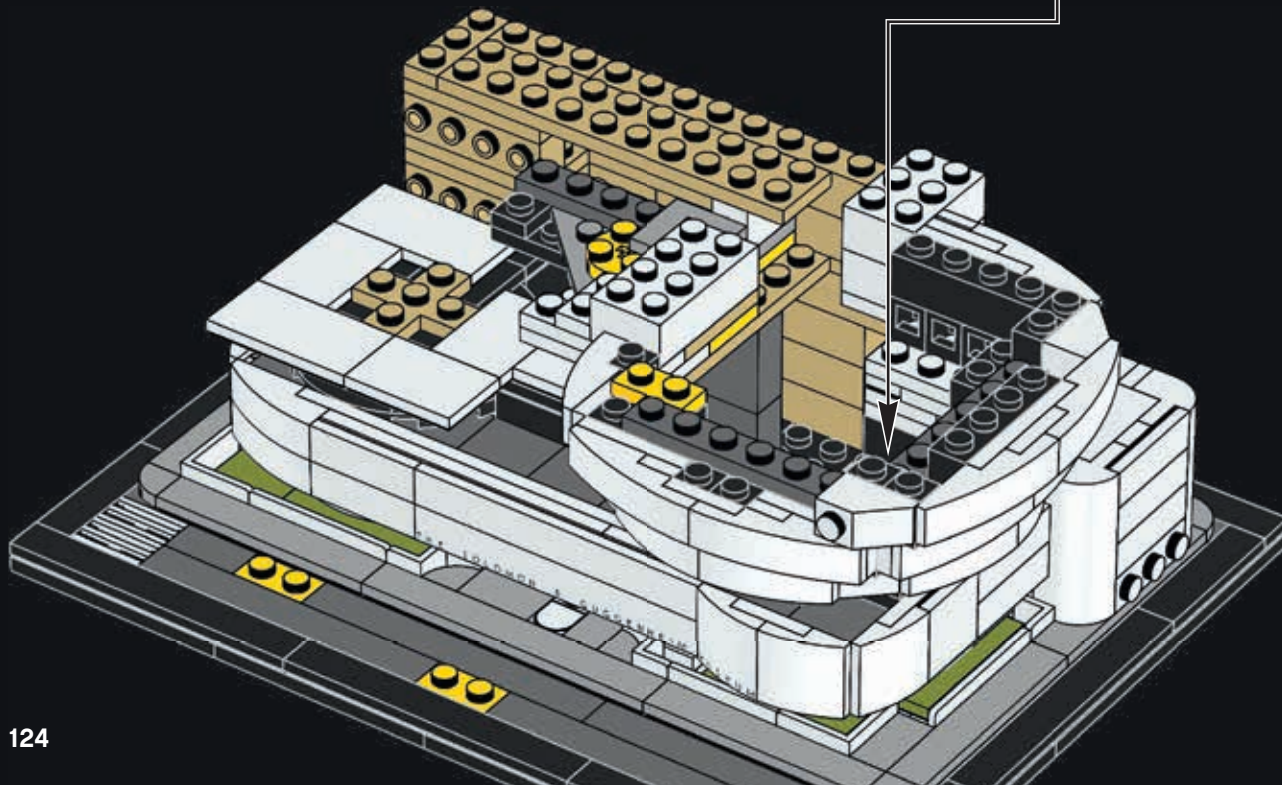

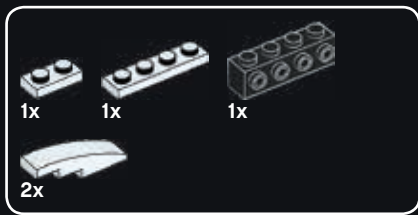

99

1

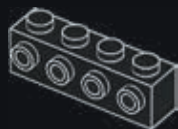

2

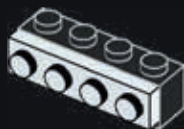

3



4

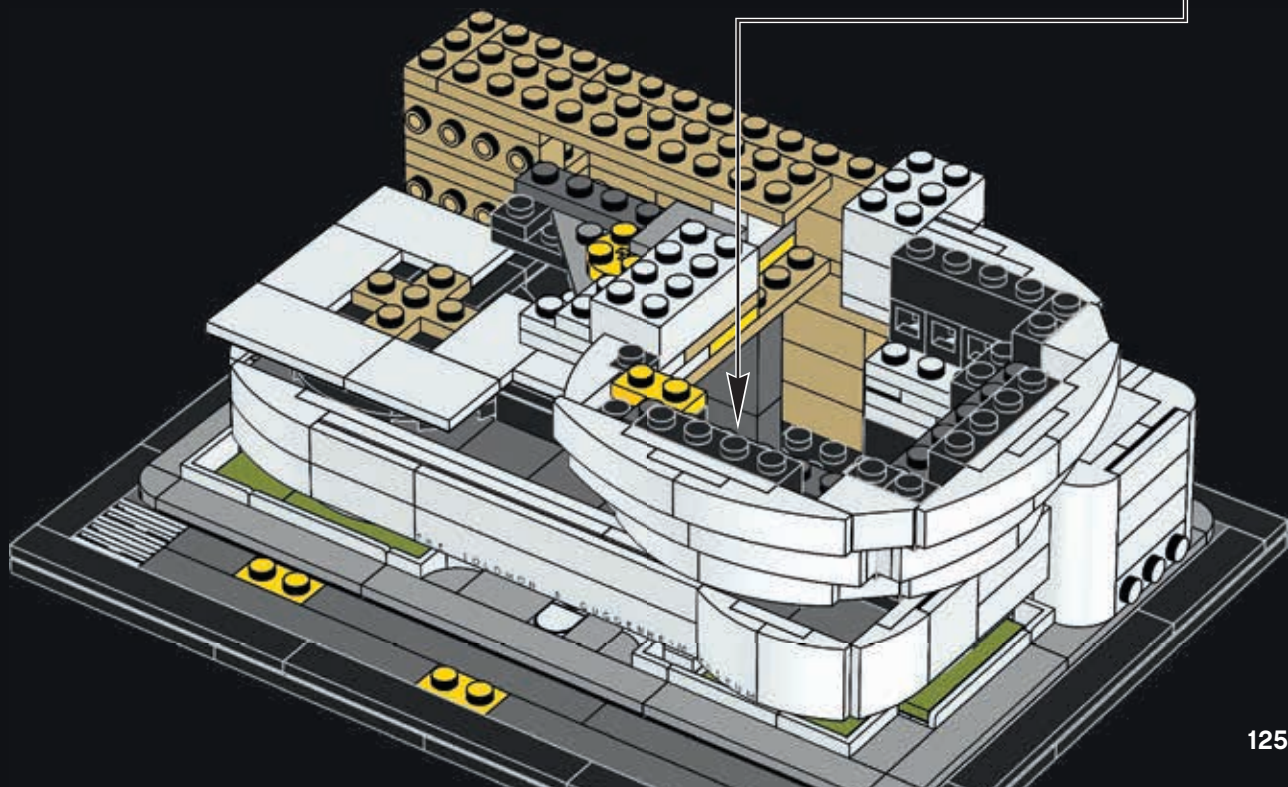



100

1



2



3



4



5

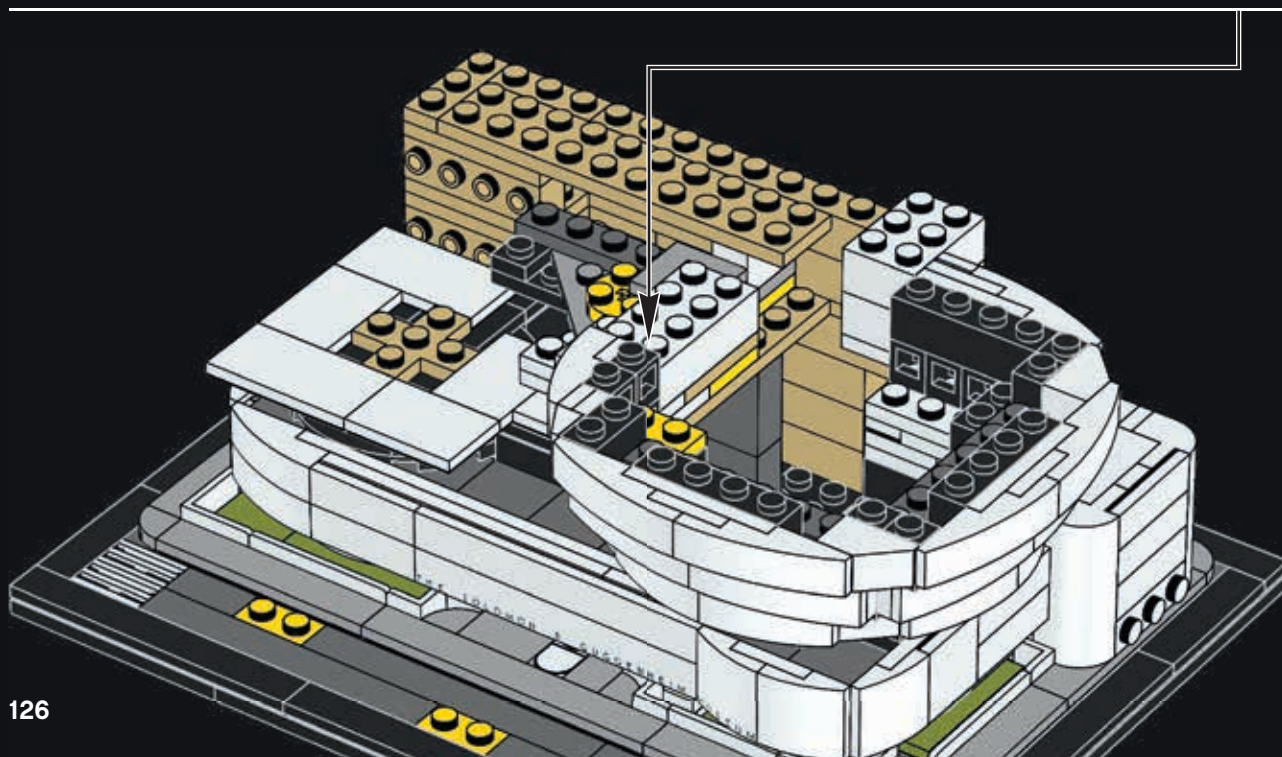
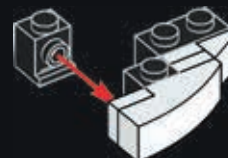



101

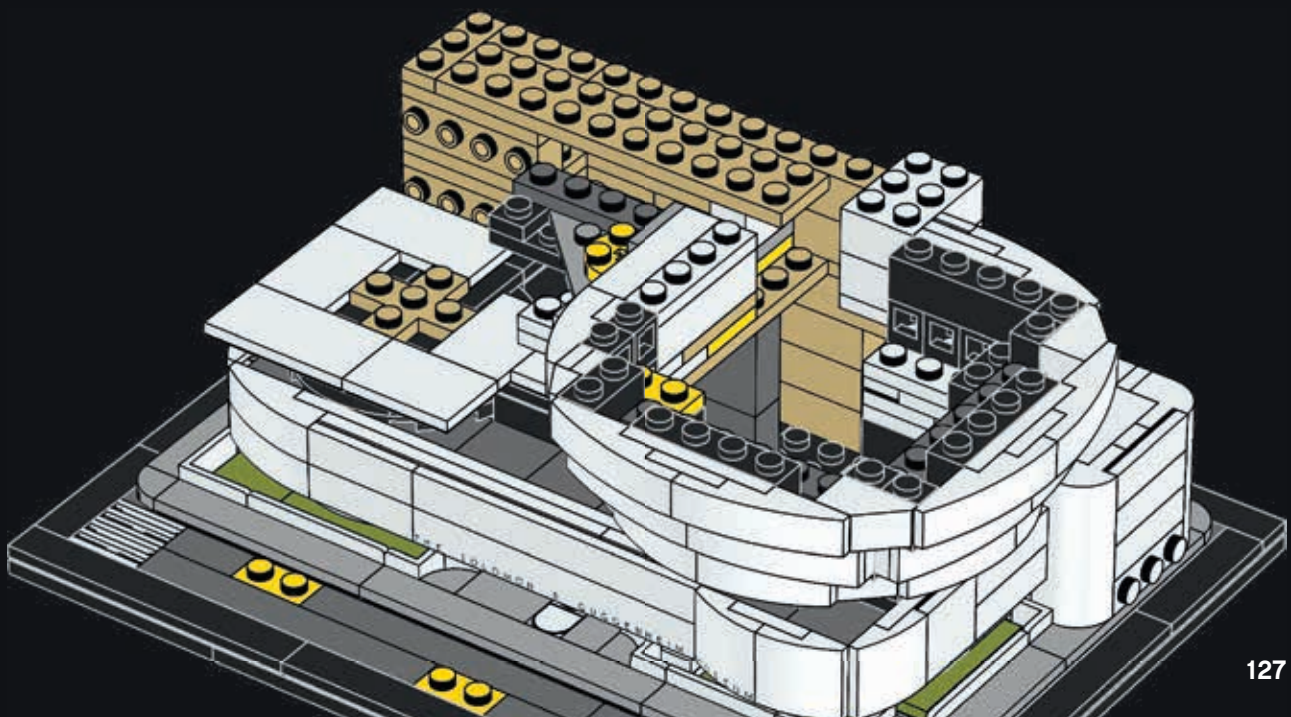



102

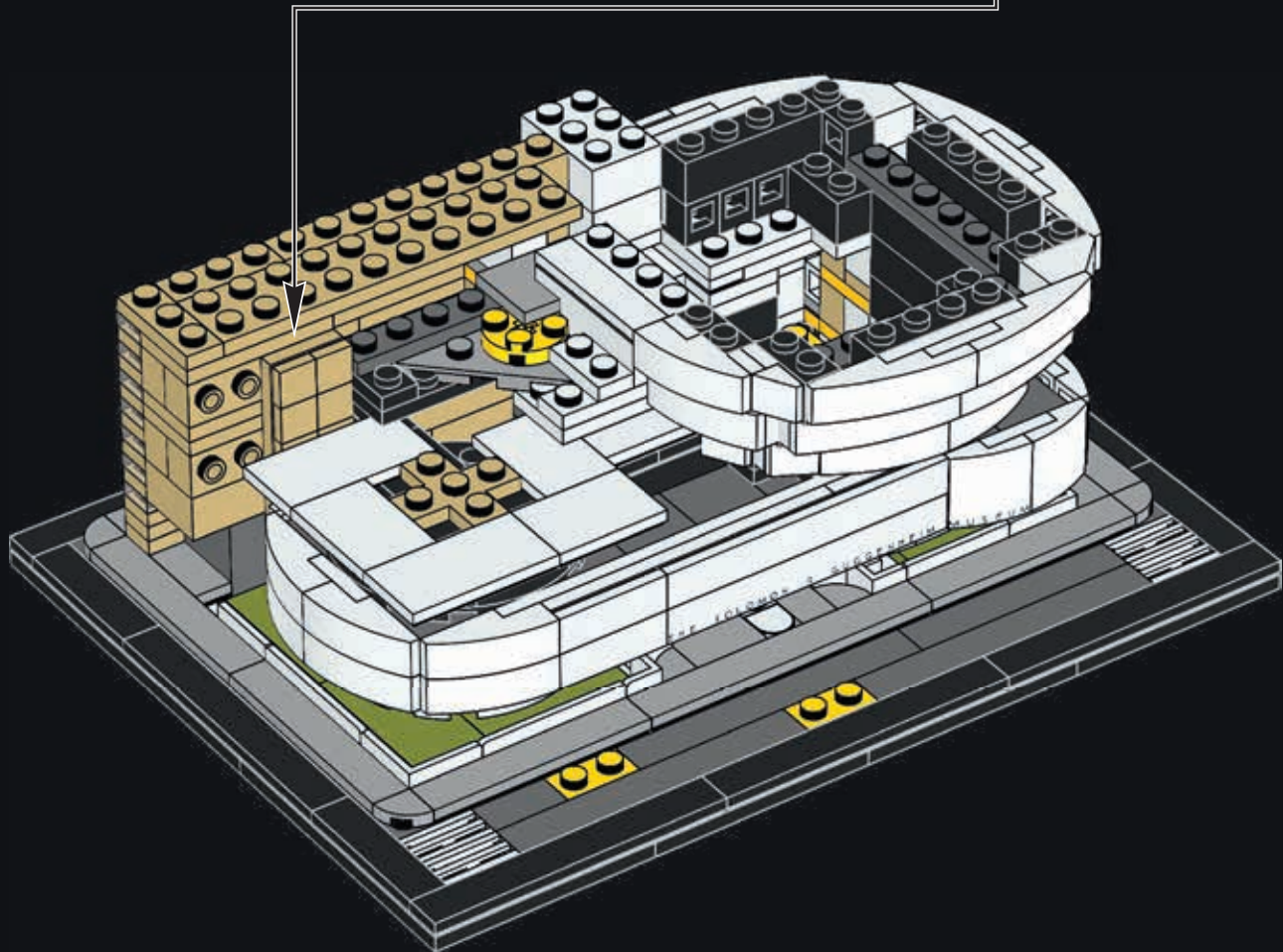
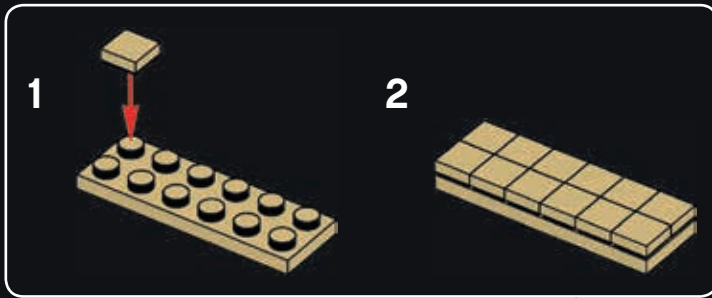

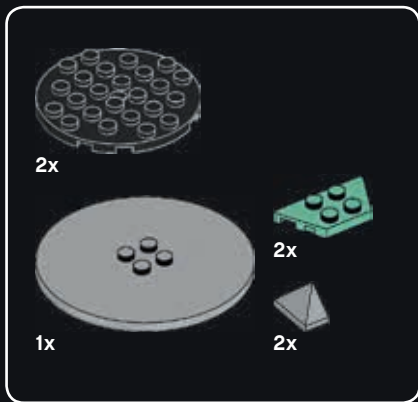

103

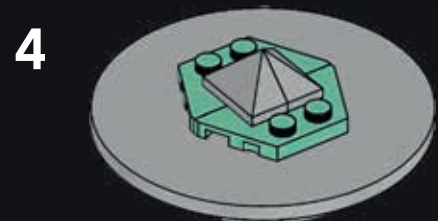
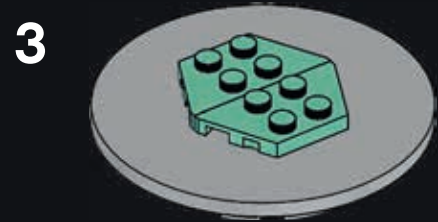
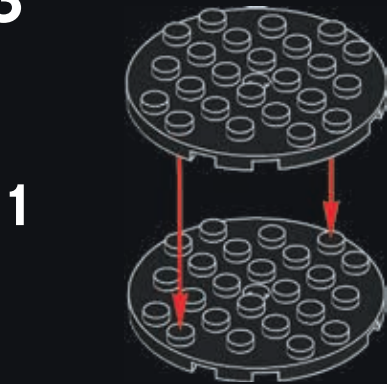

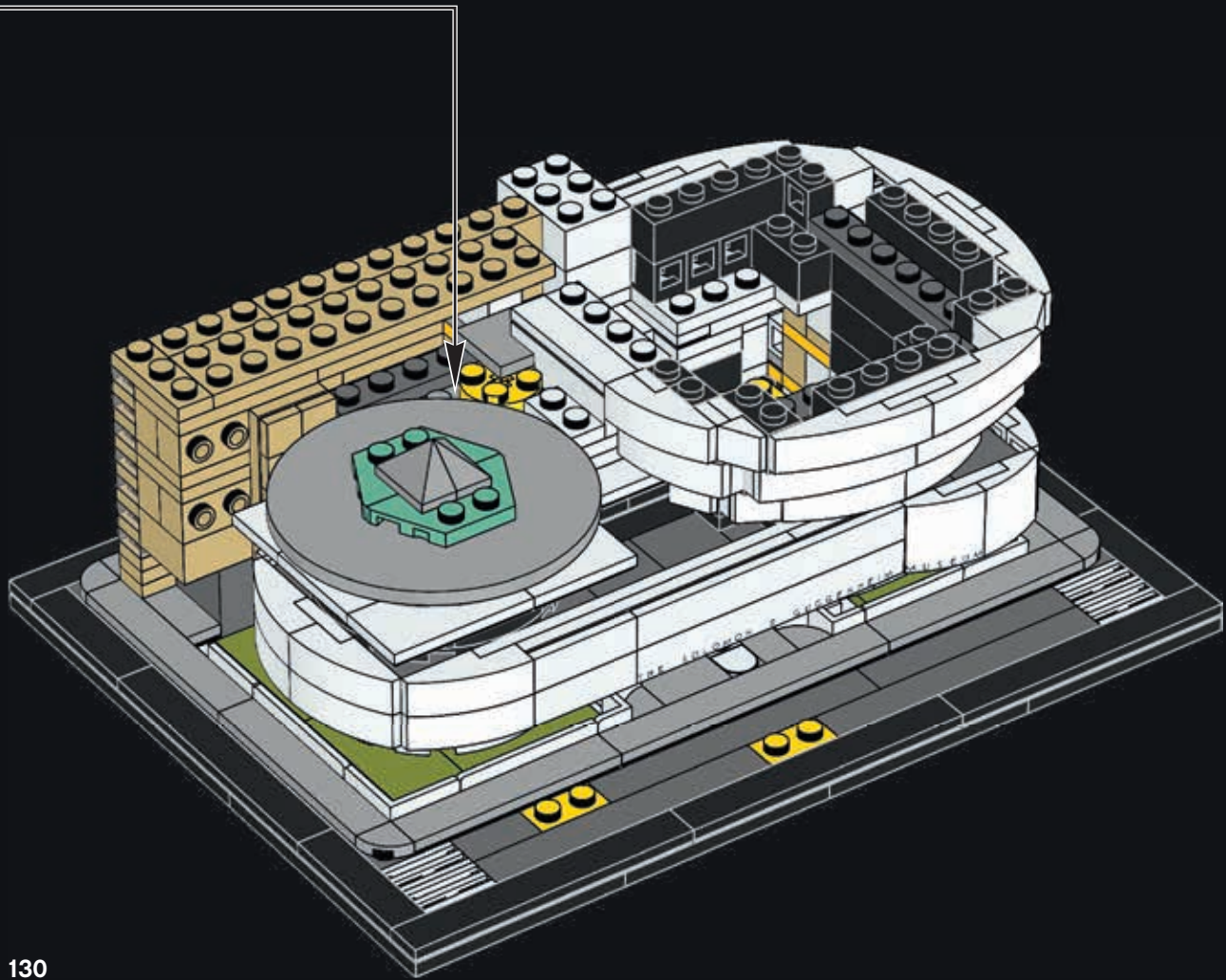



104

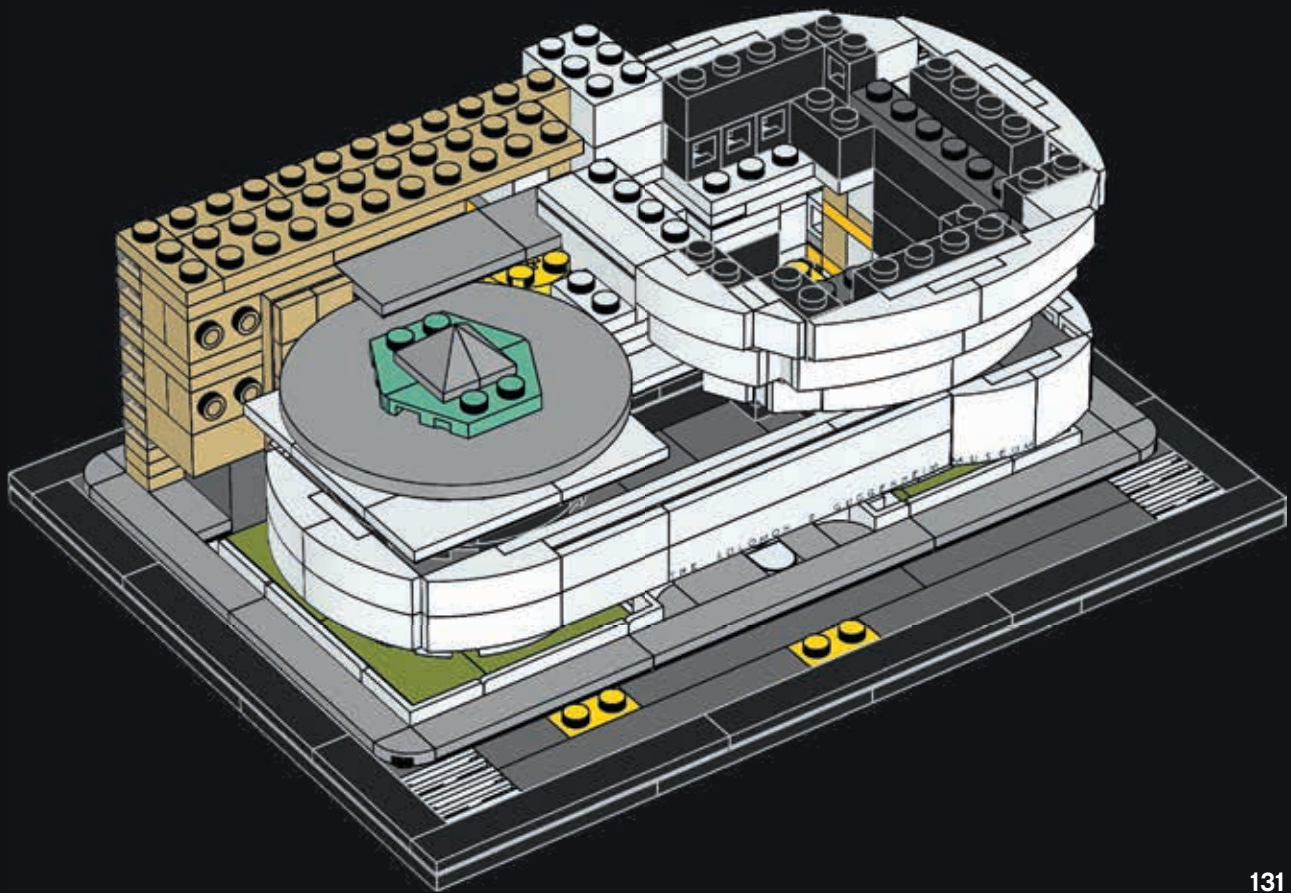



1x

105

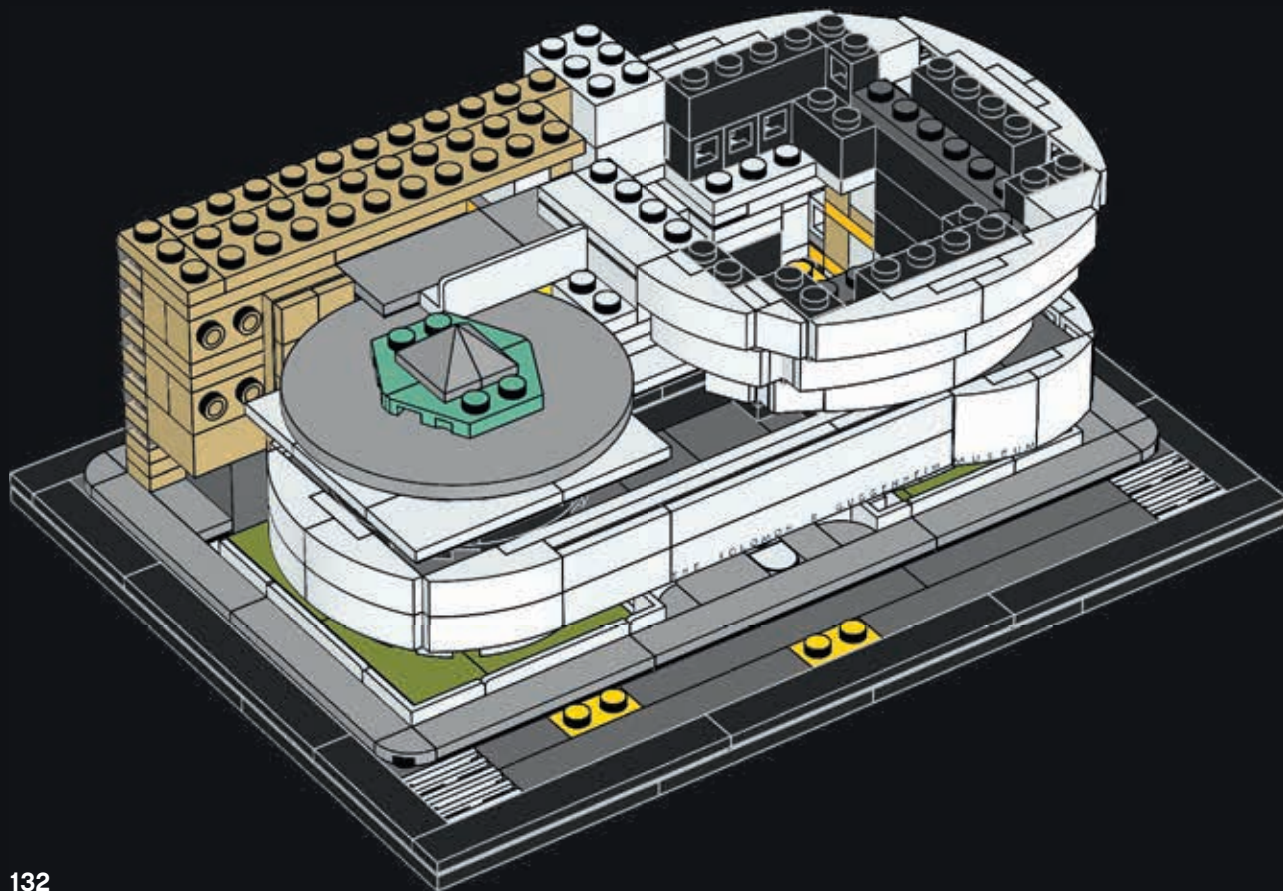



106

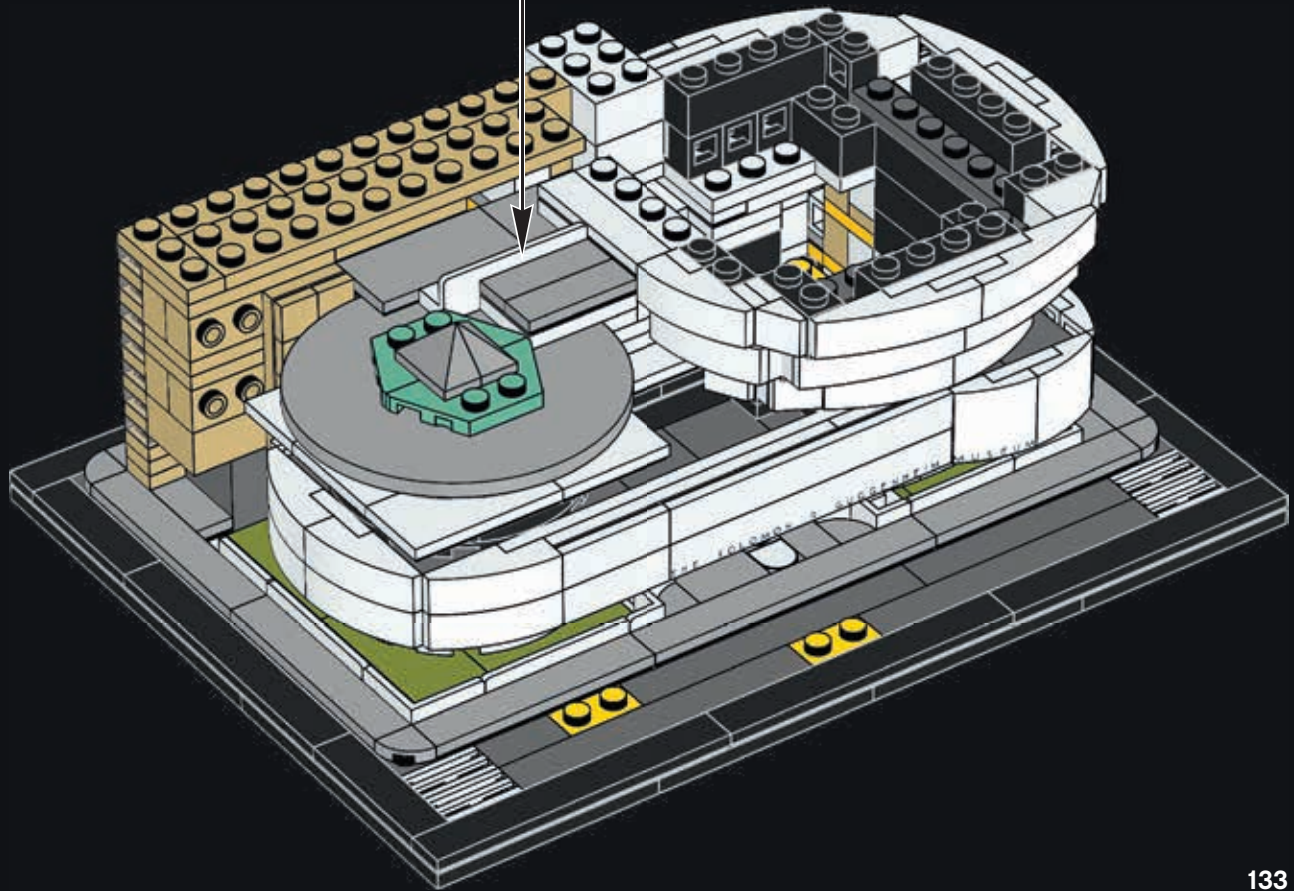
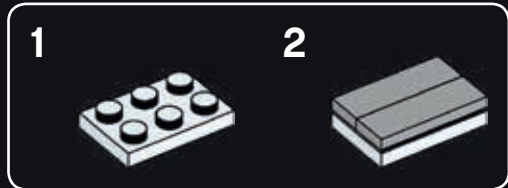



107

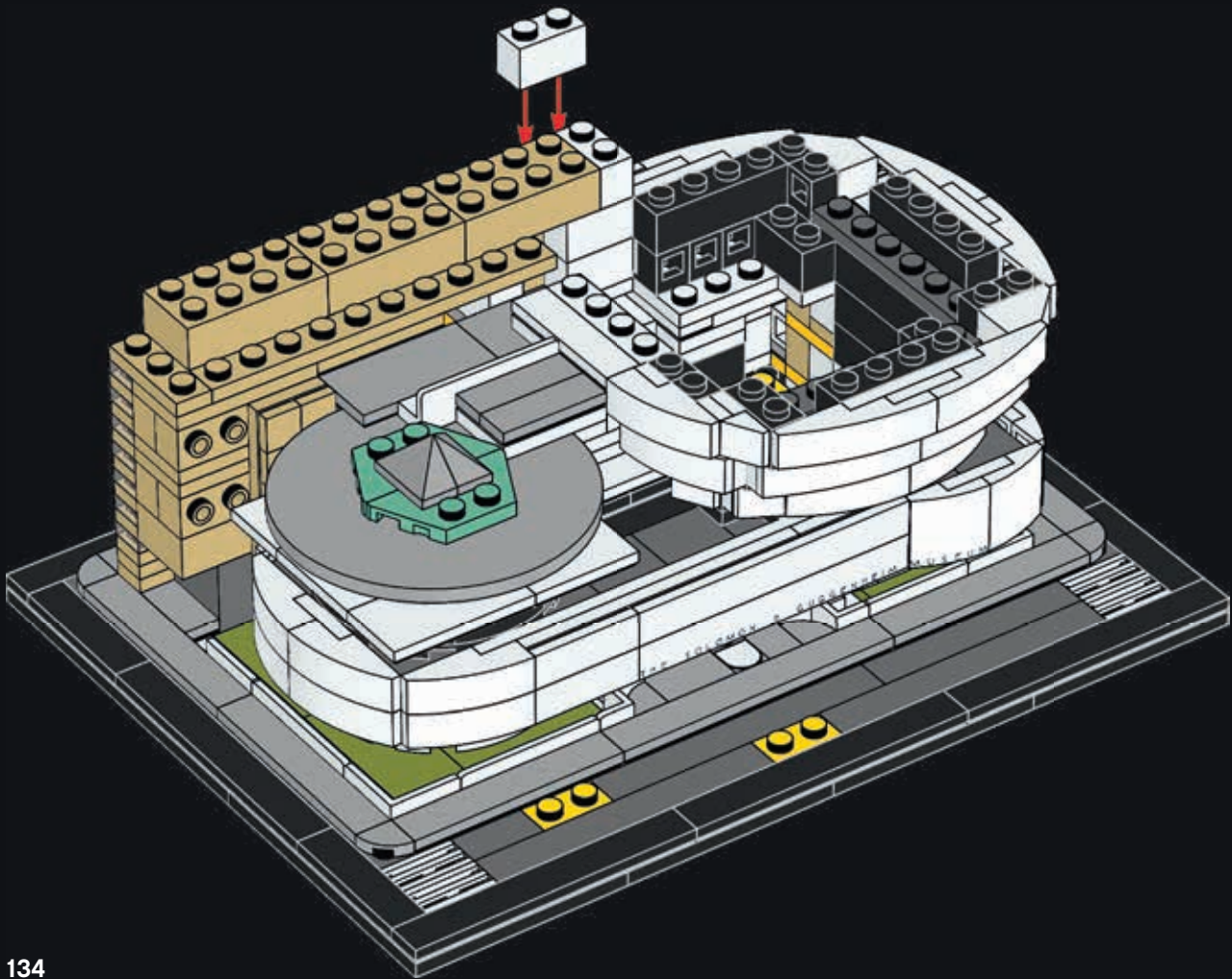



1x



1x



2x

108

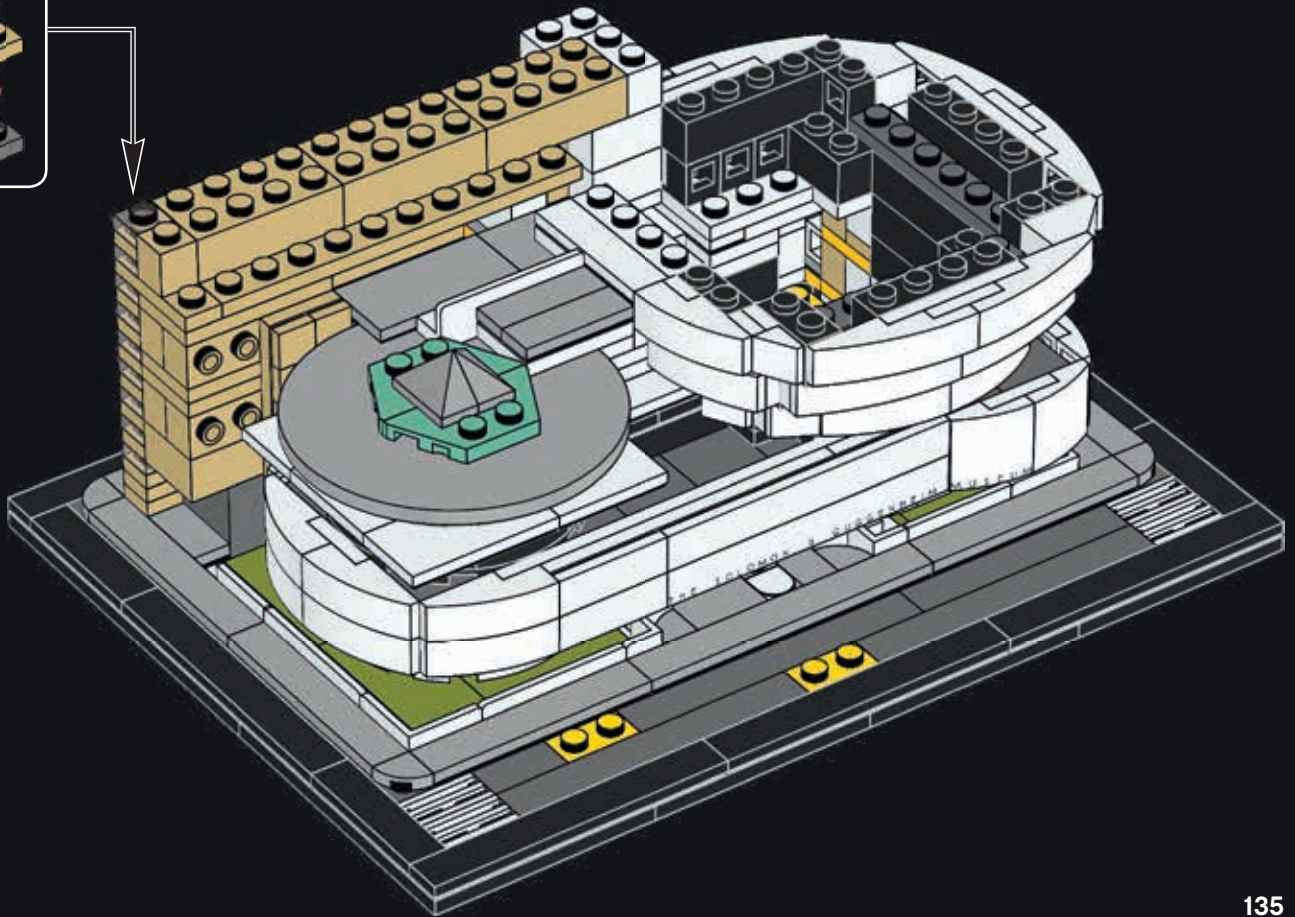

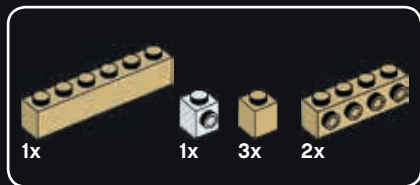

109

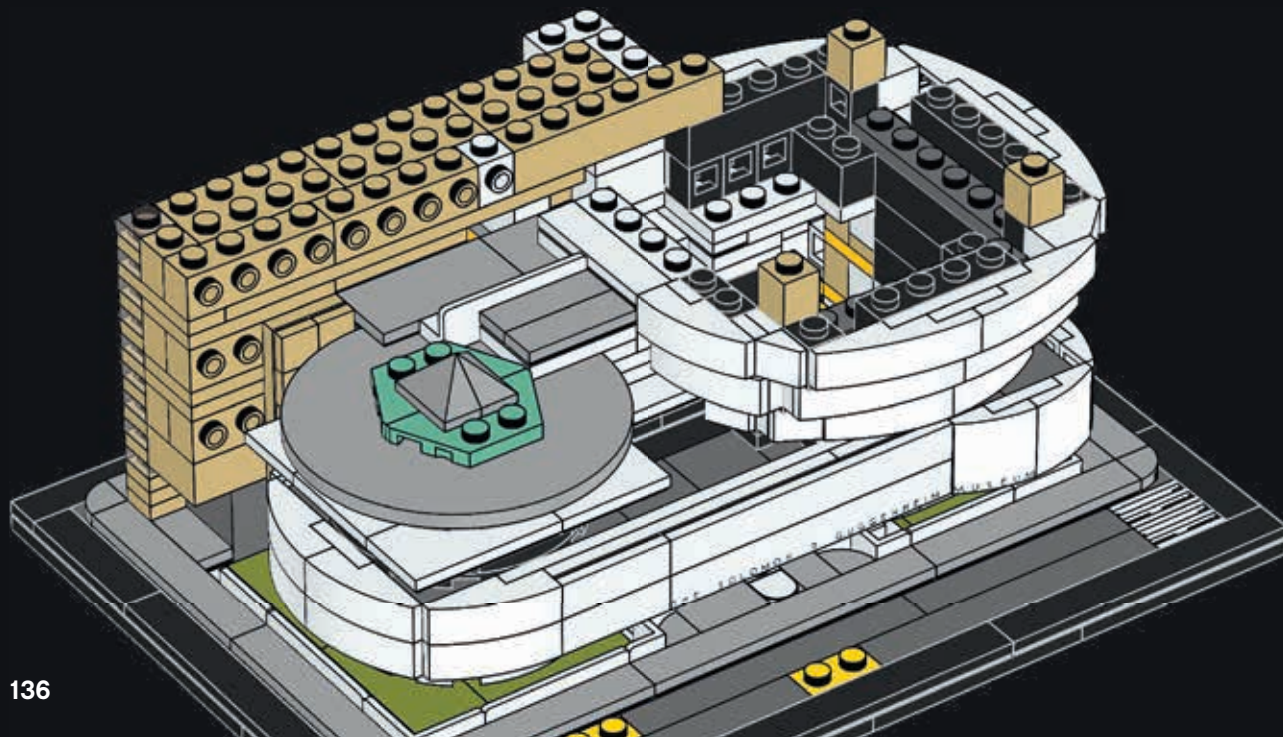



110

1



2

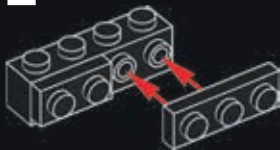

3

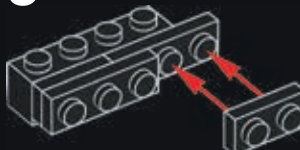

4

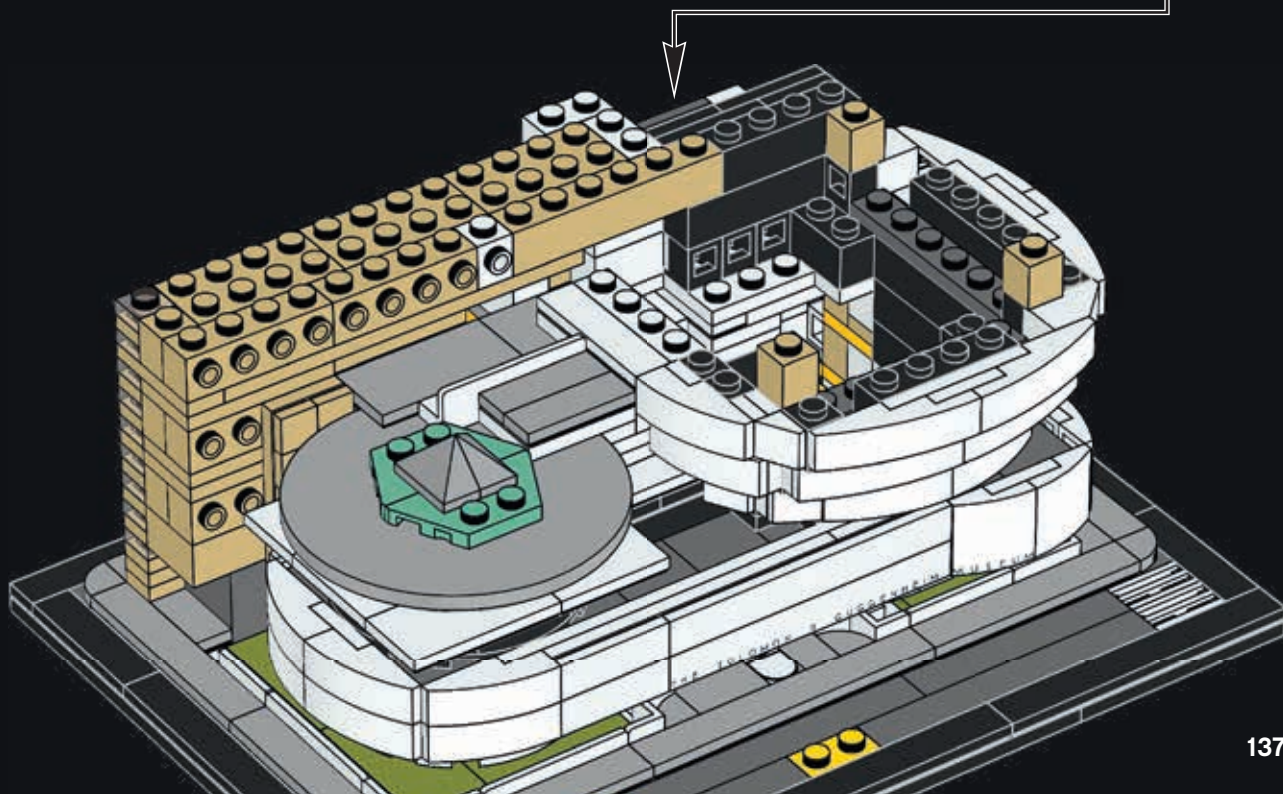
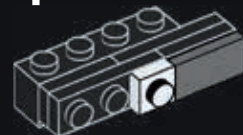

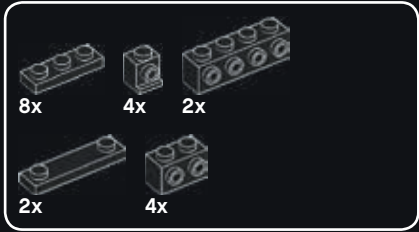

111

1



2

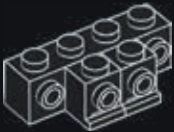

3

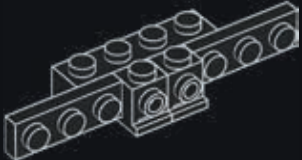

4

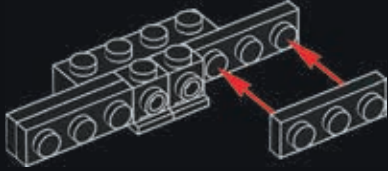

5

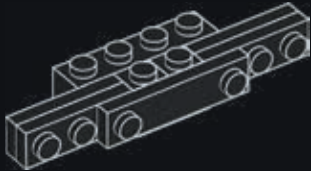

6

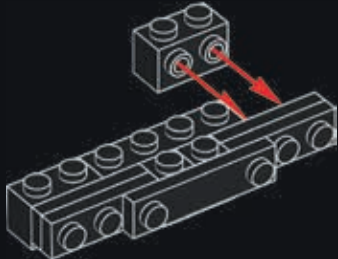

2x

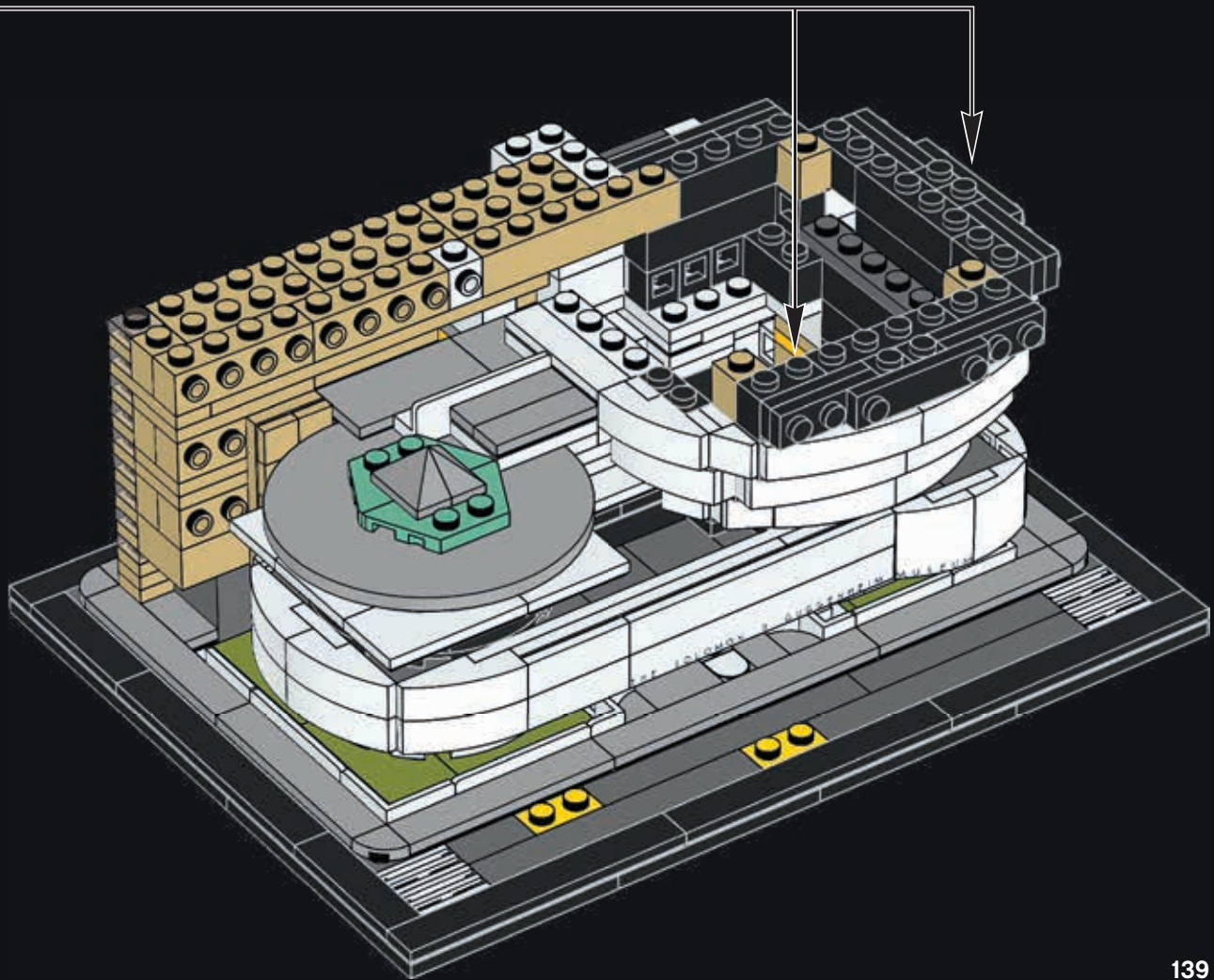



112

1

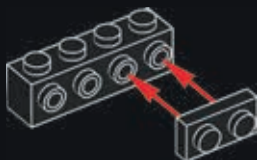

2

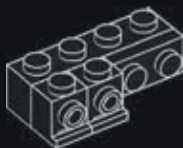

3

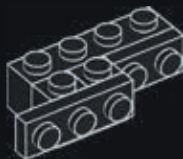

4

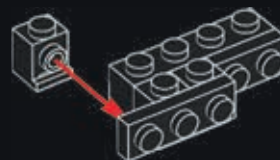

5

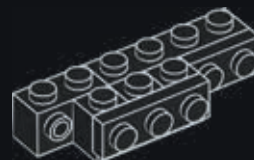

6

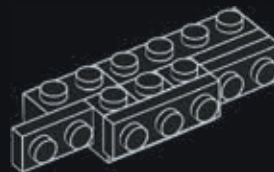

7

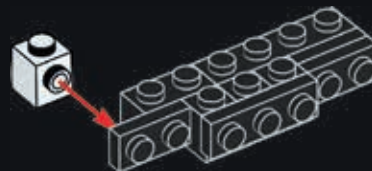

It took \$3 million to build the Guggenheim Museum between 1943-1959.
The restoration of the exterior from 2005 to 2008 cost \$2 million.

Il a fallu 3 millions de dollars pour construire le musée Guggenheim entre 1943 et 1959.
La restauration de l'extérieur de 2005 à 2008 a coûté 2 millions de dollars.

La construcción del Museo Solomon R. Guggenheim, que se prolongó desde 1943 hasta 1959,
supuso un coste de 3 millones de dólares. La restauración del exterior,
llevada a cabo entre 2005 y 2008, tuvo un coste de 2 millones de dólares.



@The Solomon R. Guggenheim
Foundation, New York

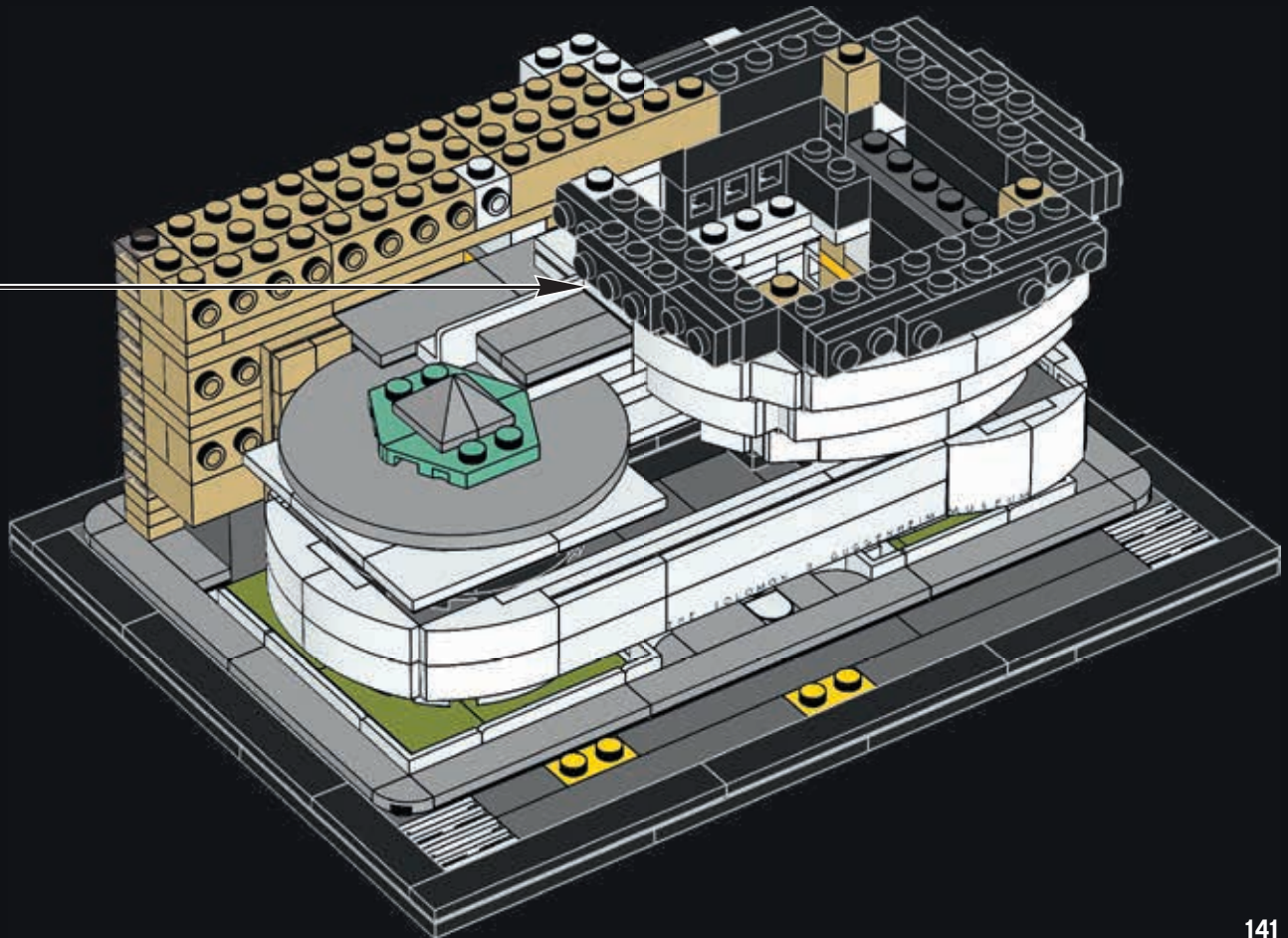



113

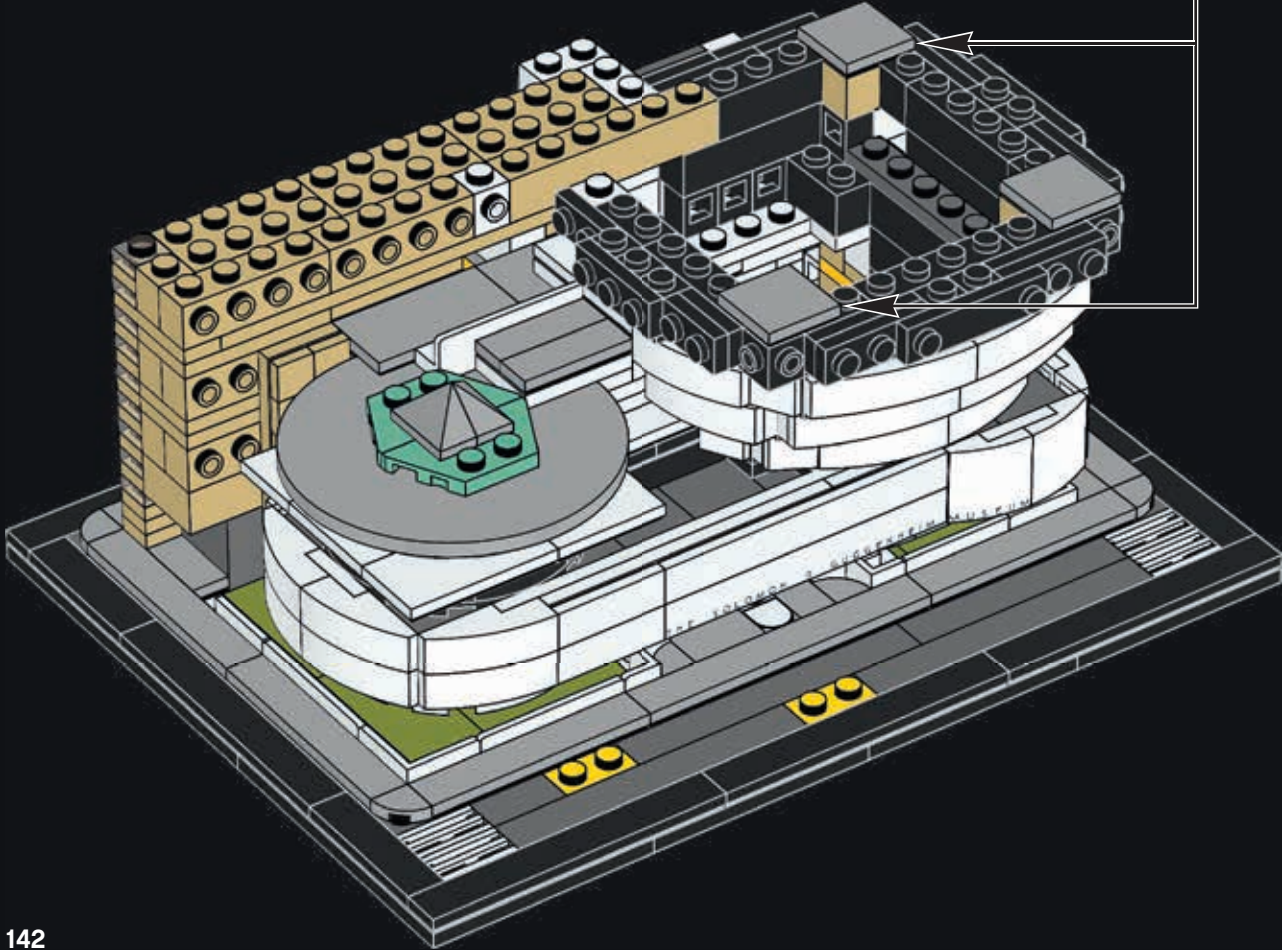



114

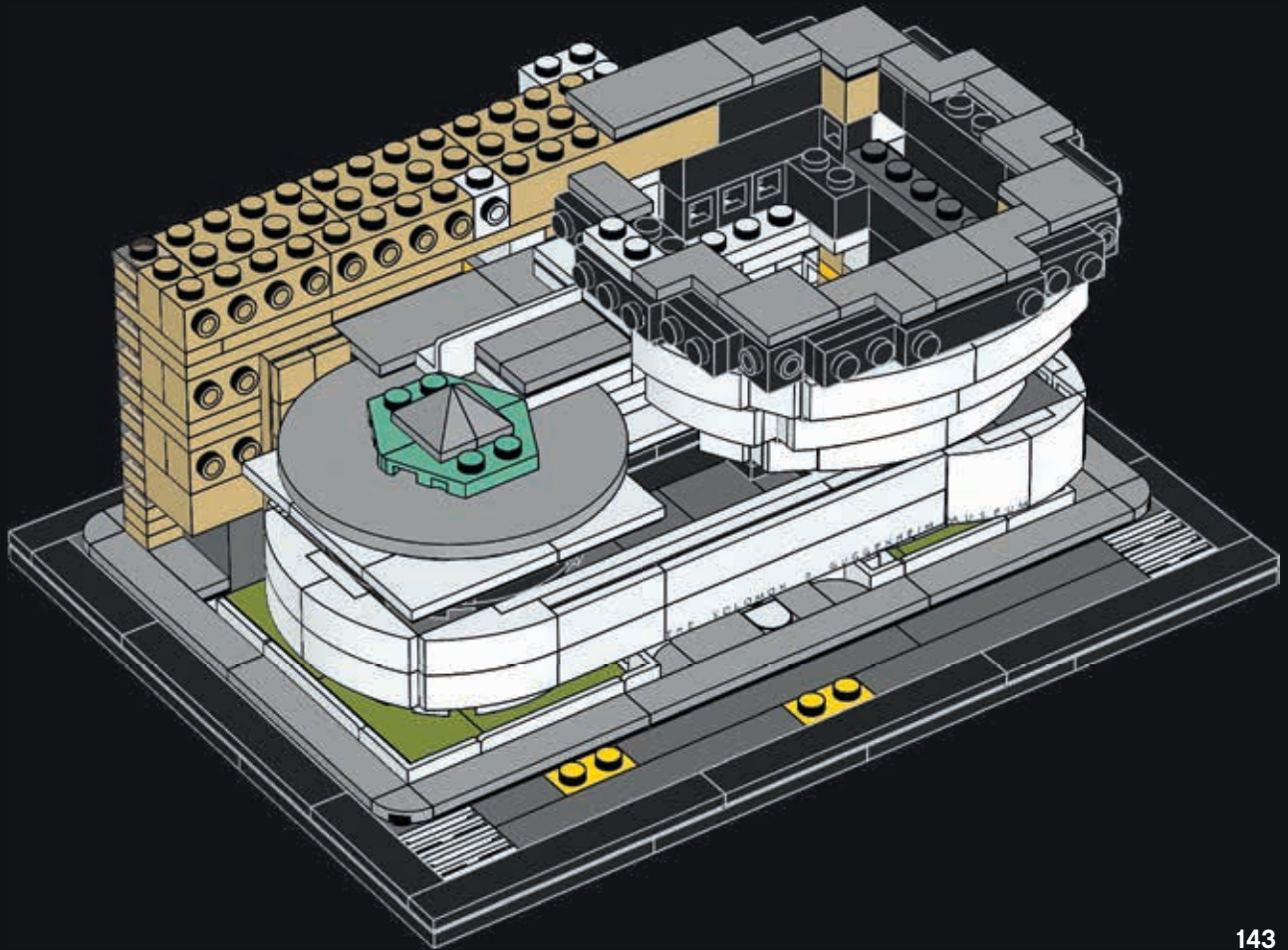



115

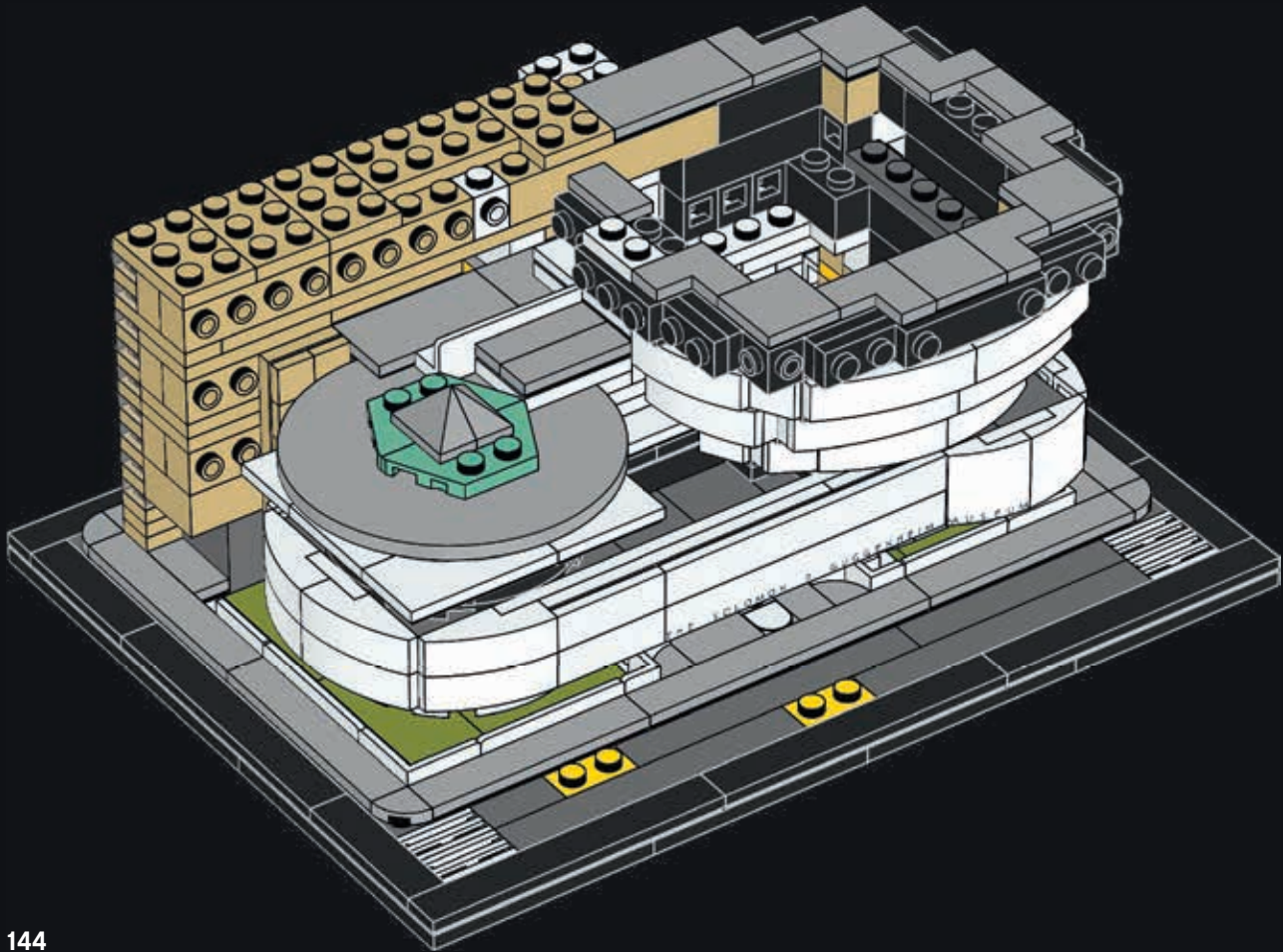



116

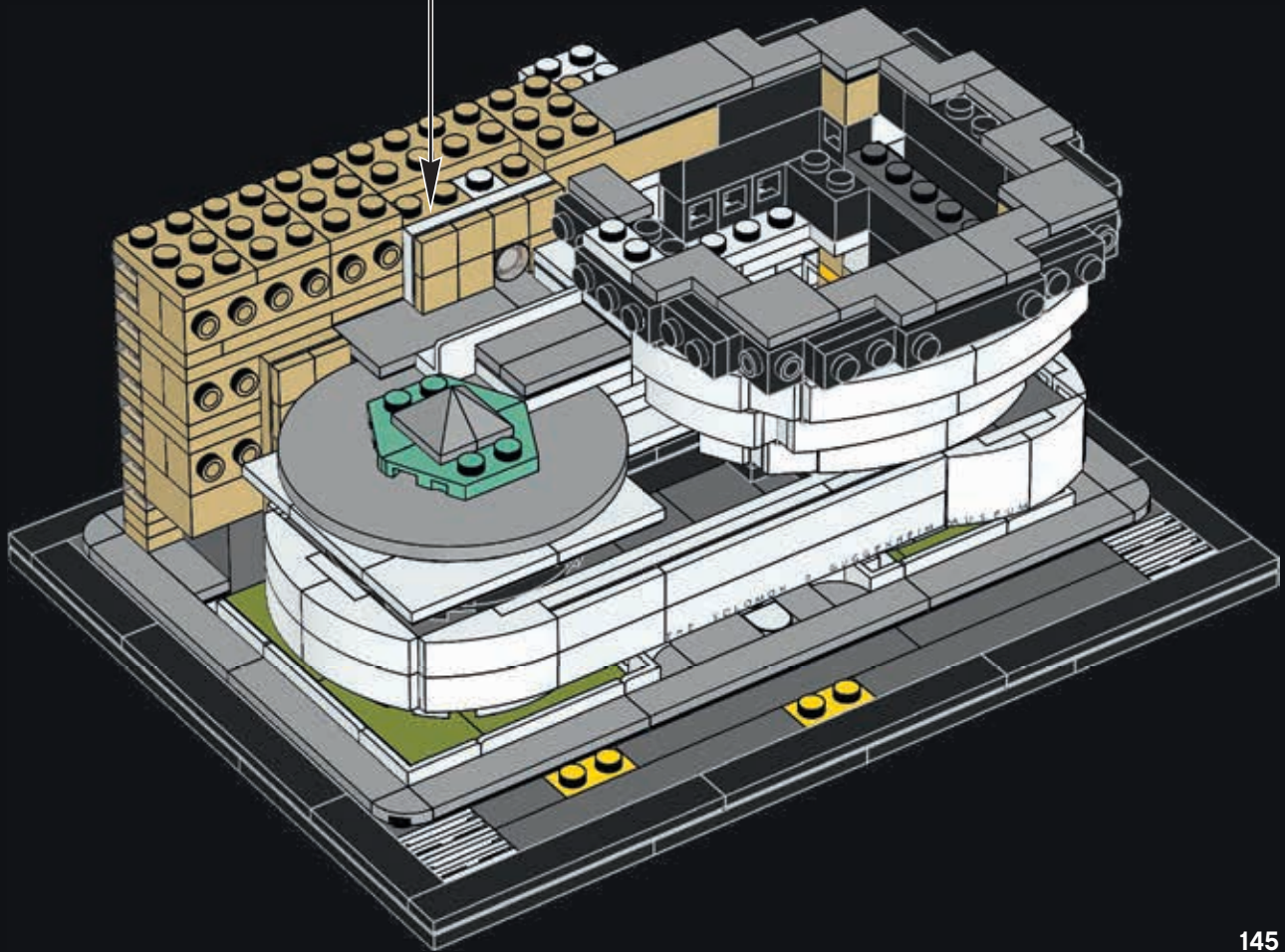
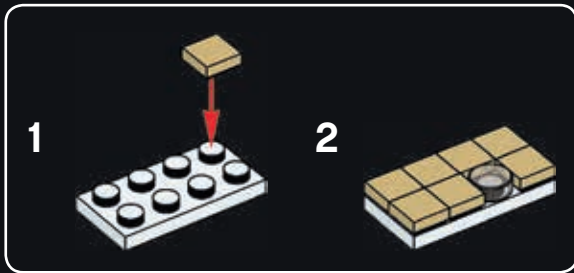



4x

117

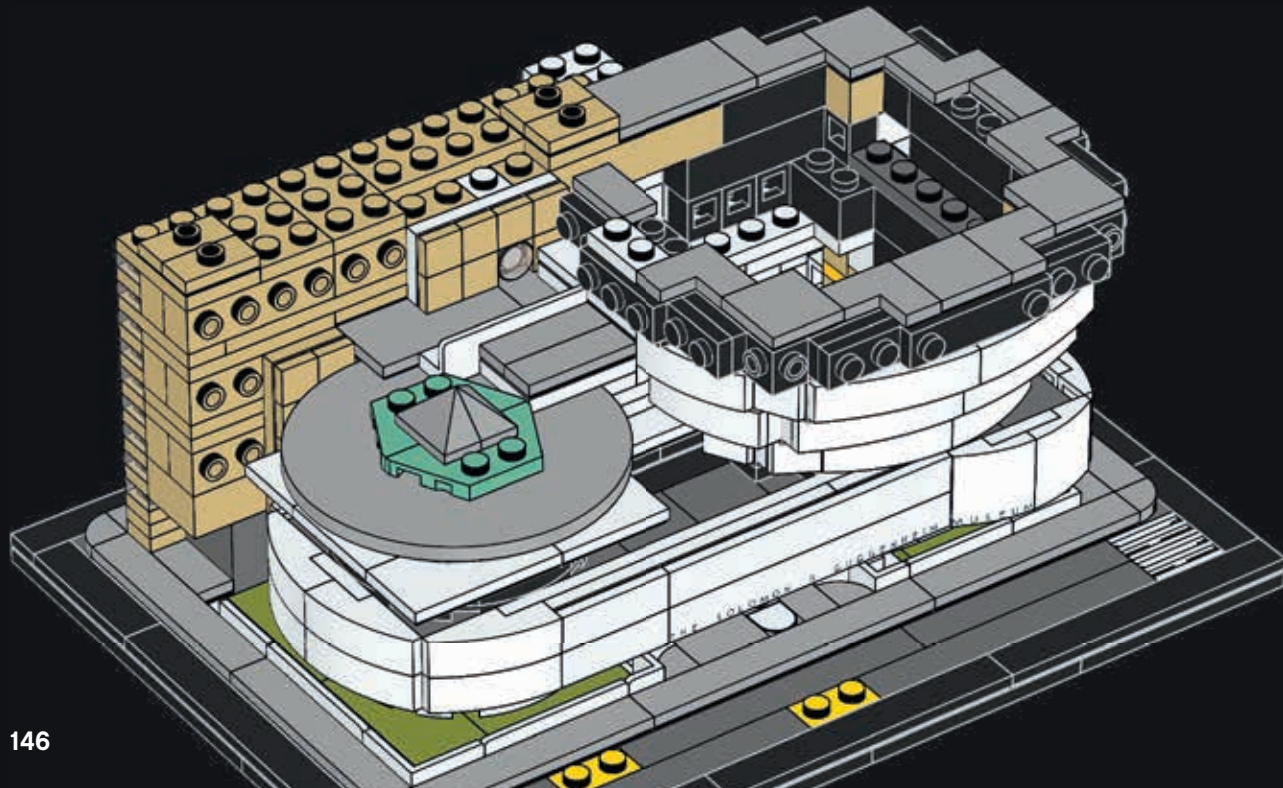

146

2x 3x 2x

118

1



2



3



4

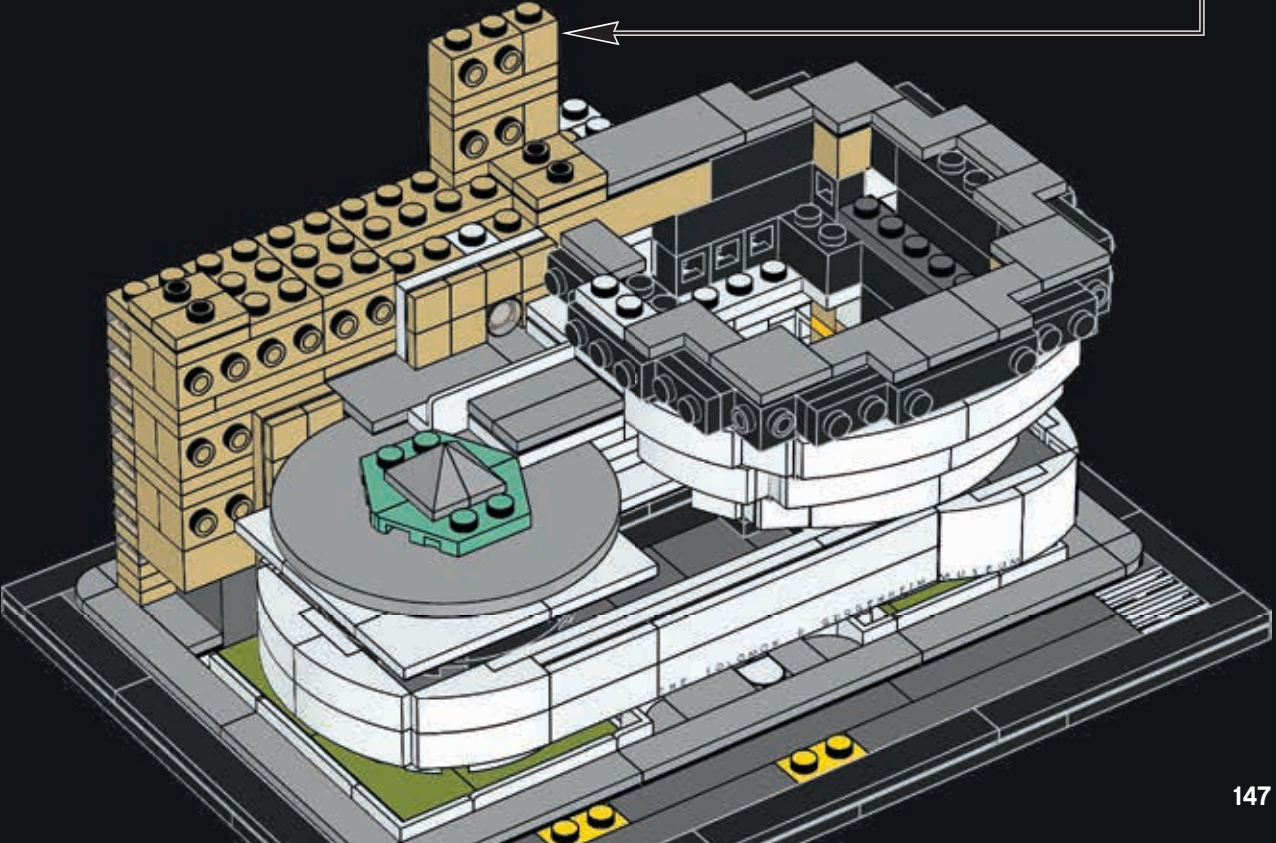



3x

119

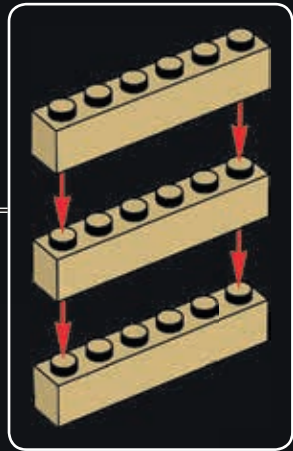
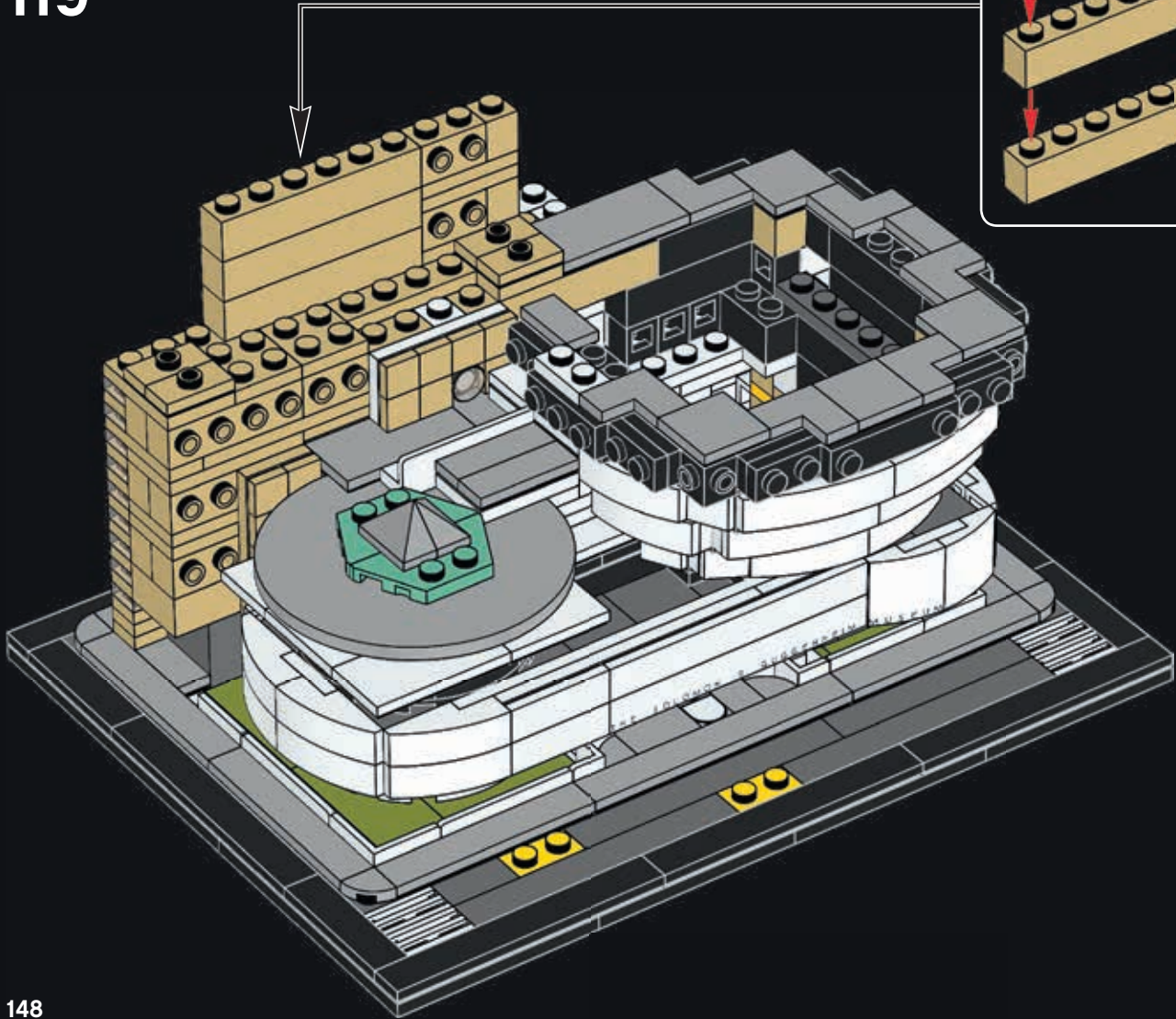



2x



1x

120

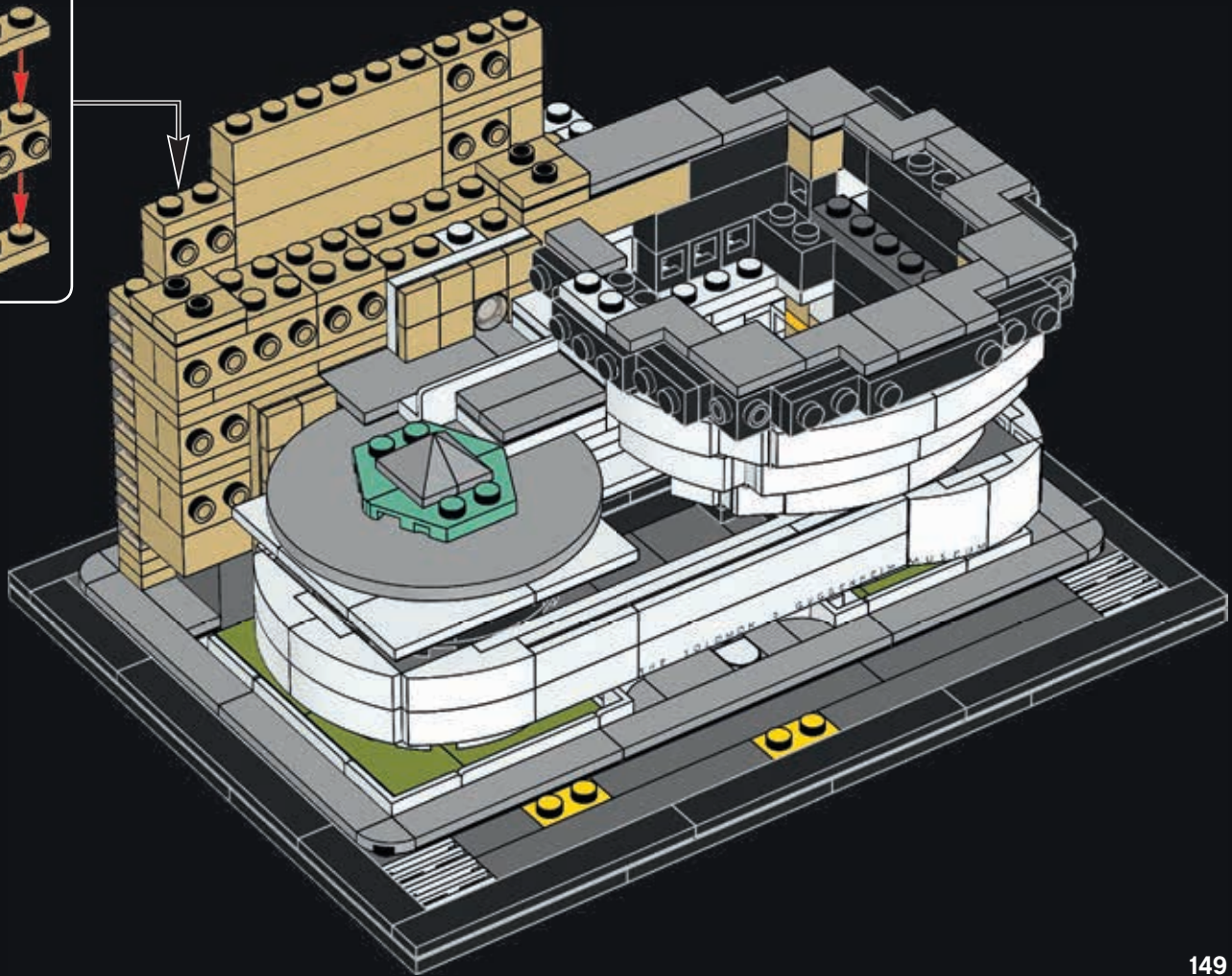
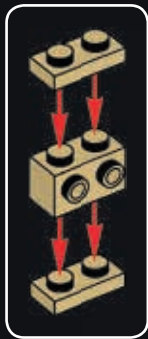



2x



3x

121

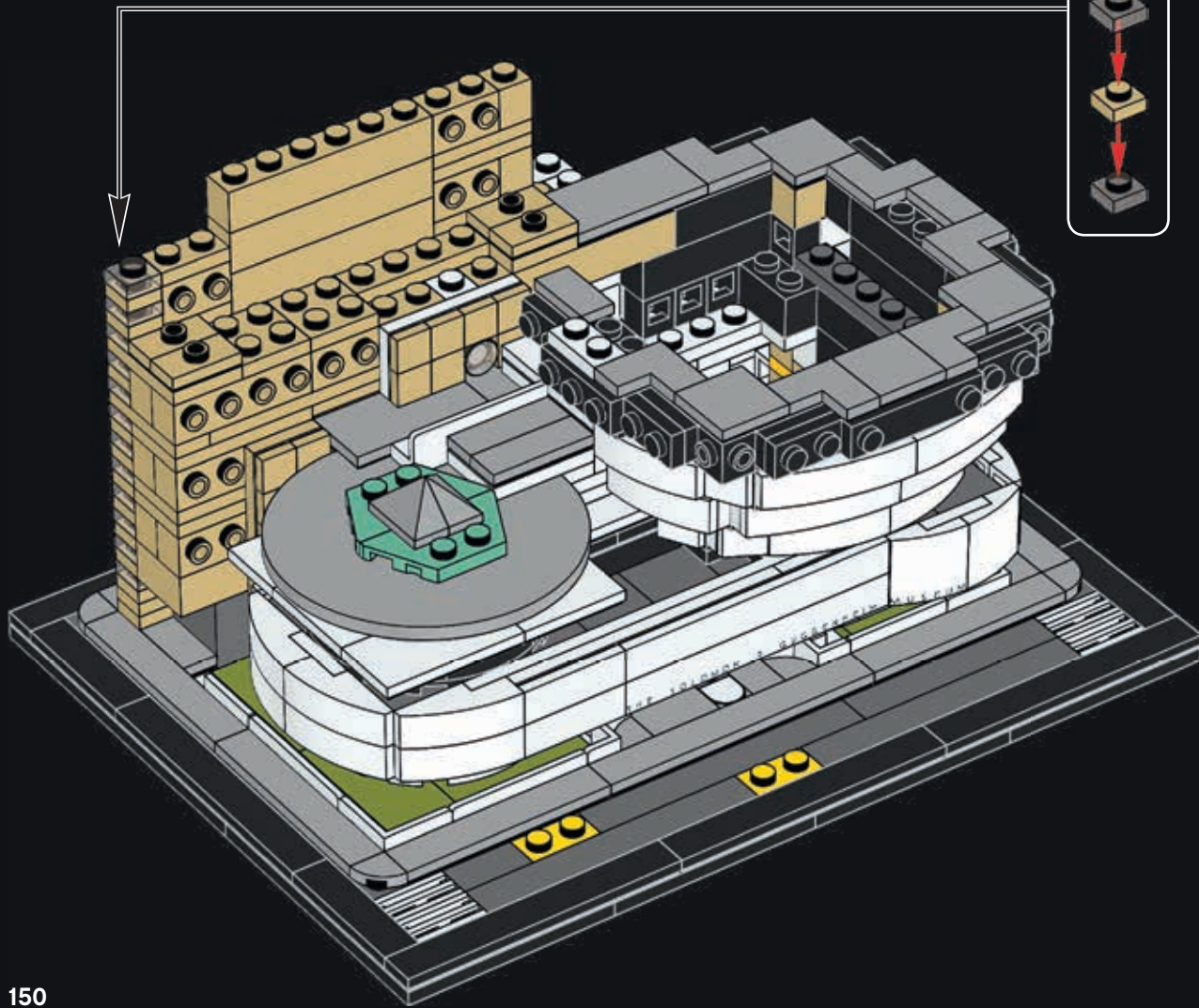



122

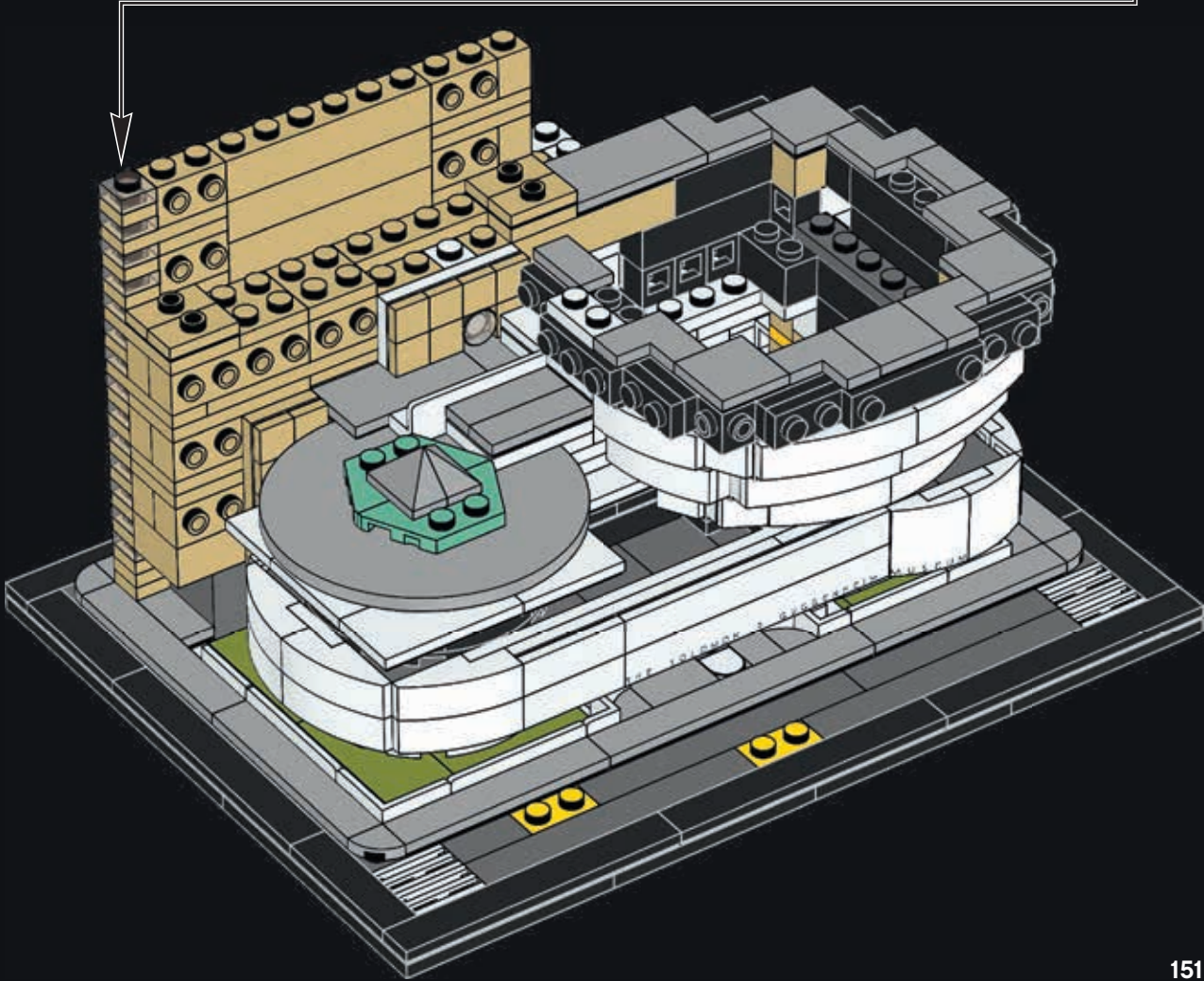



123

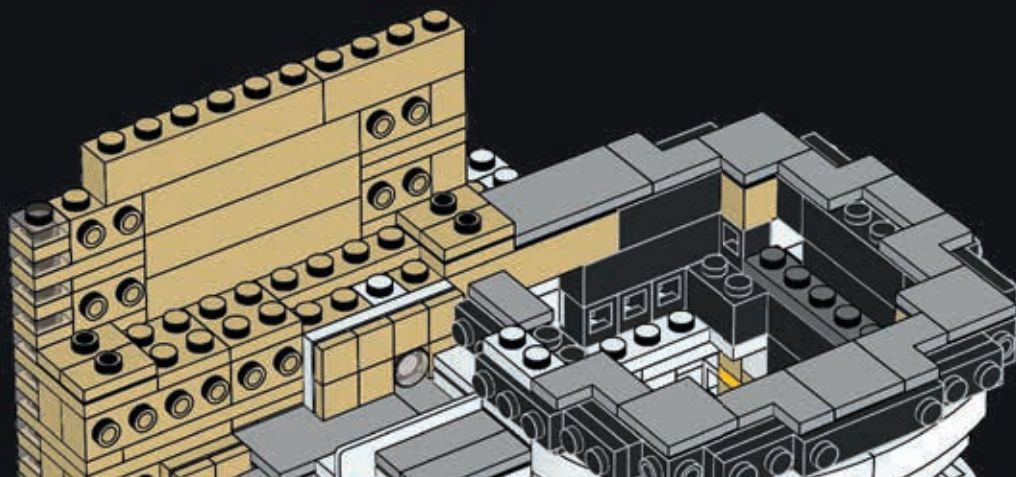

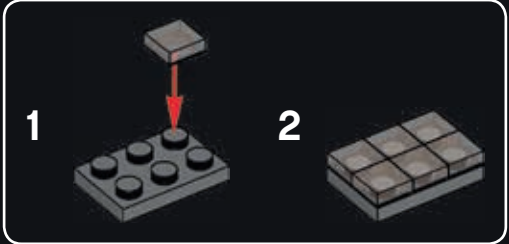
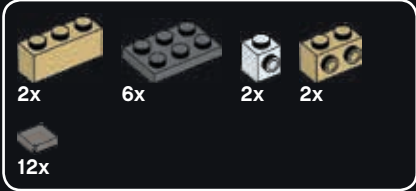

124

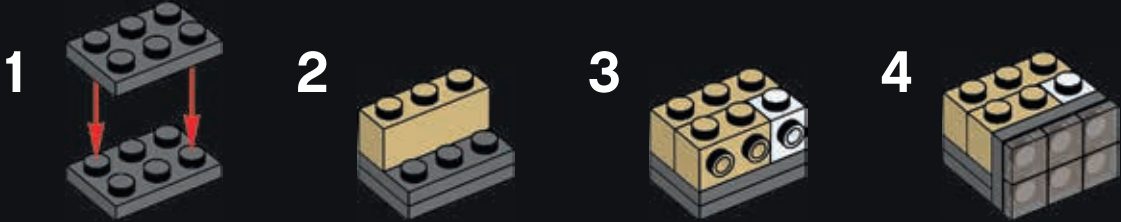

2x

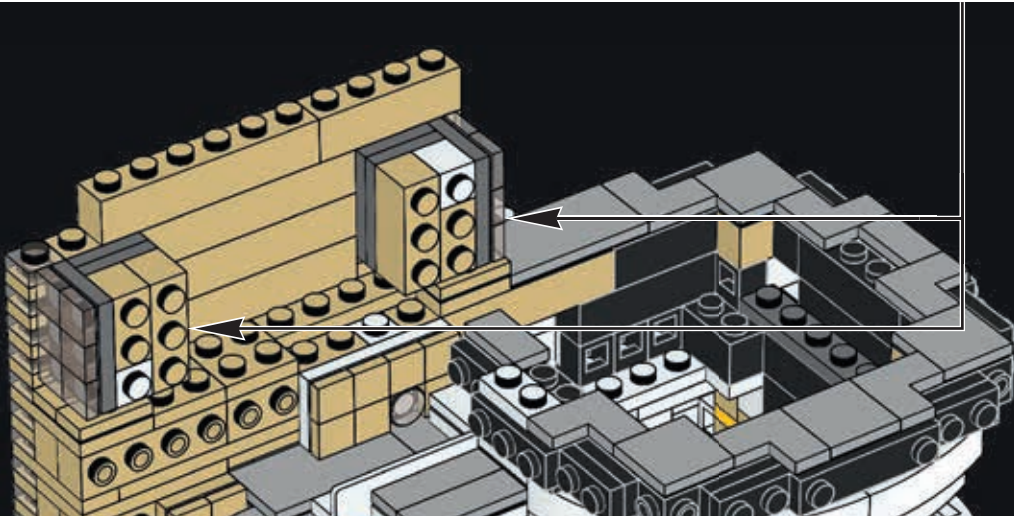



125

1

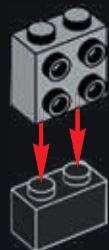

2



3



4

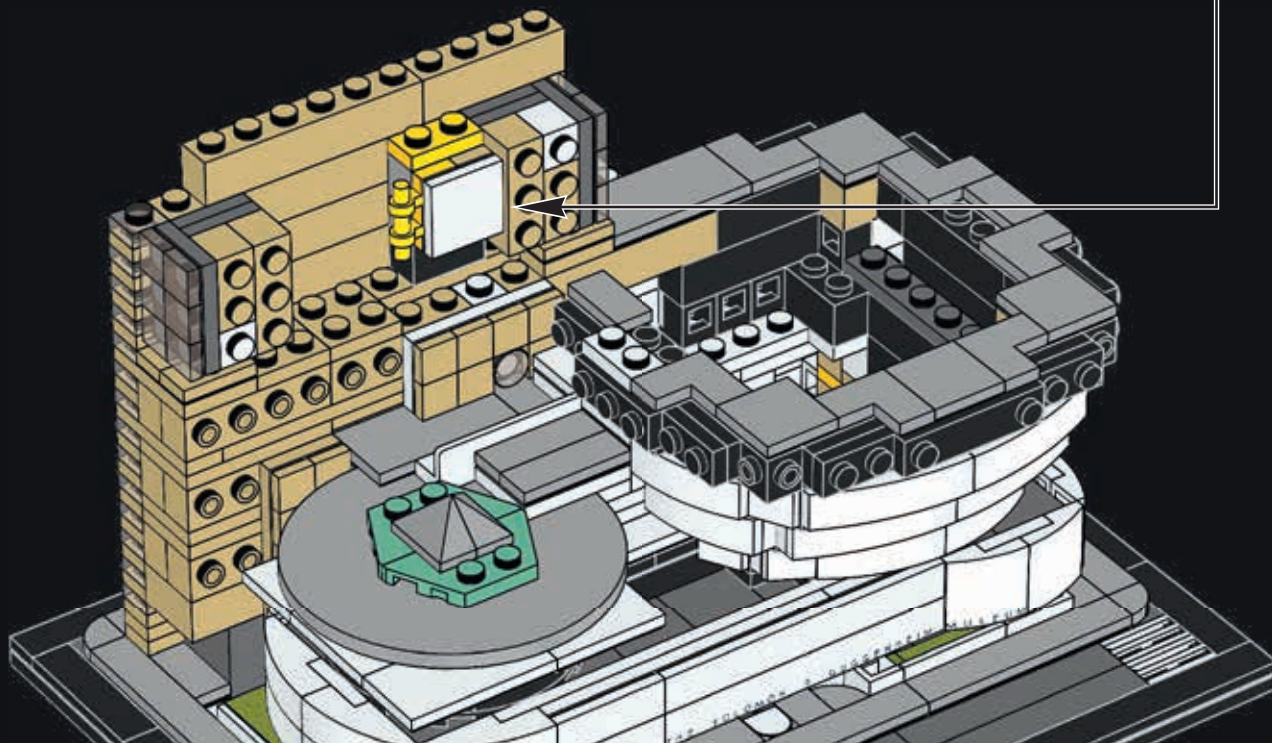

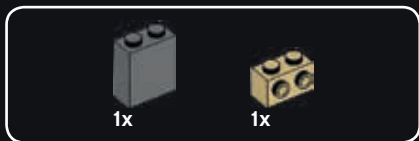

126

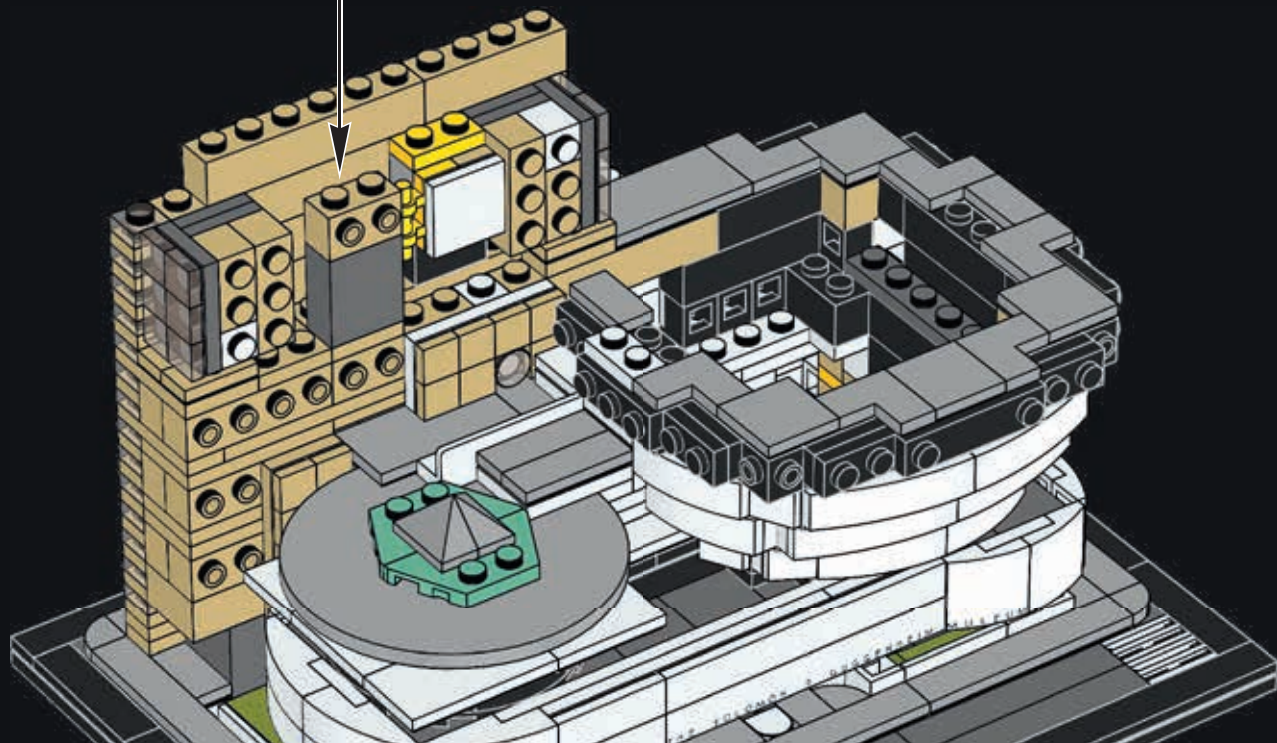
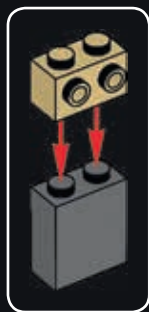

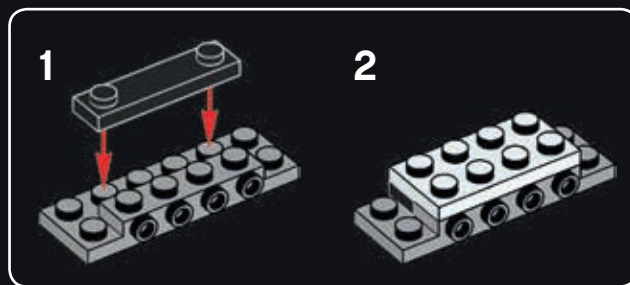
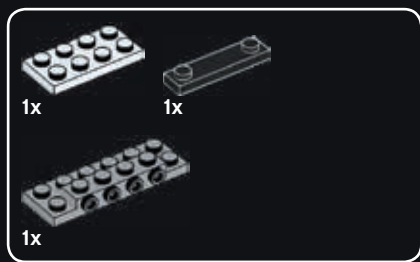

127

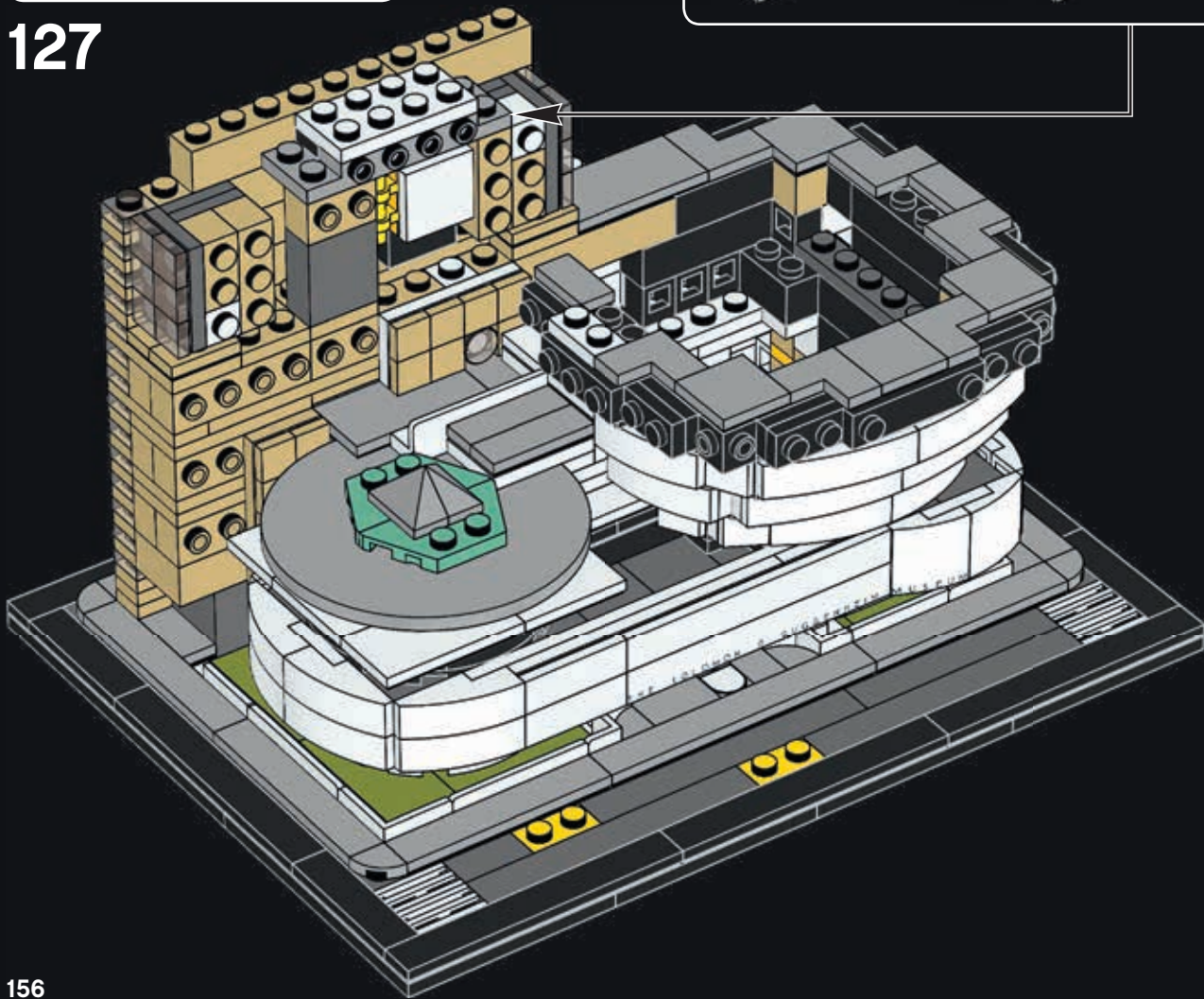



1x

128

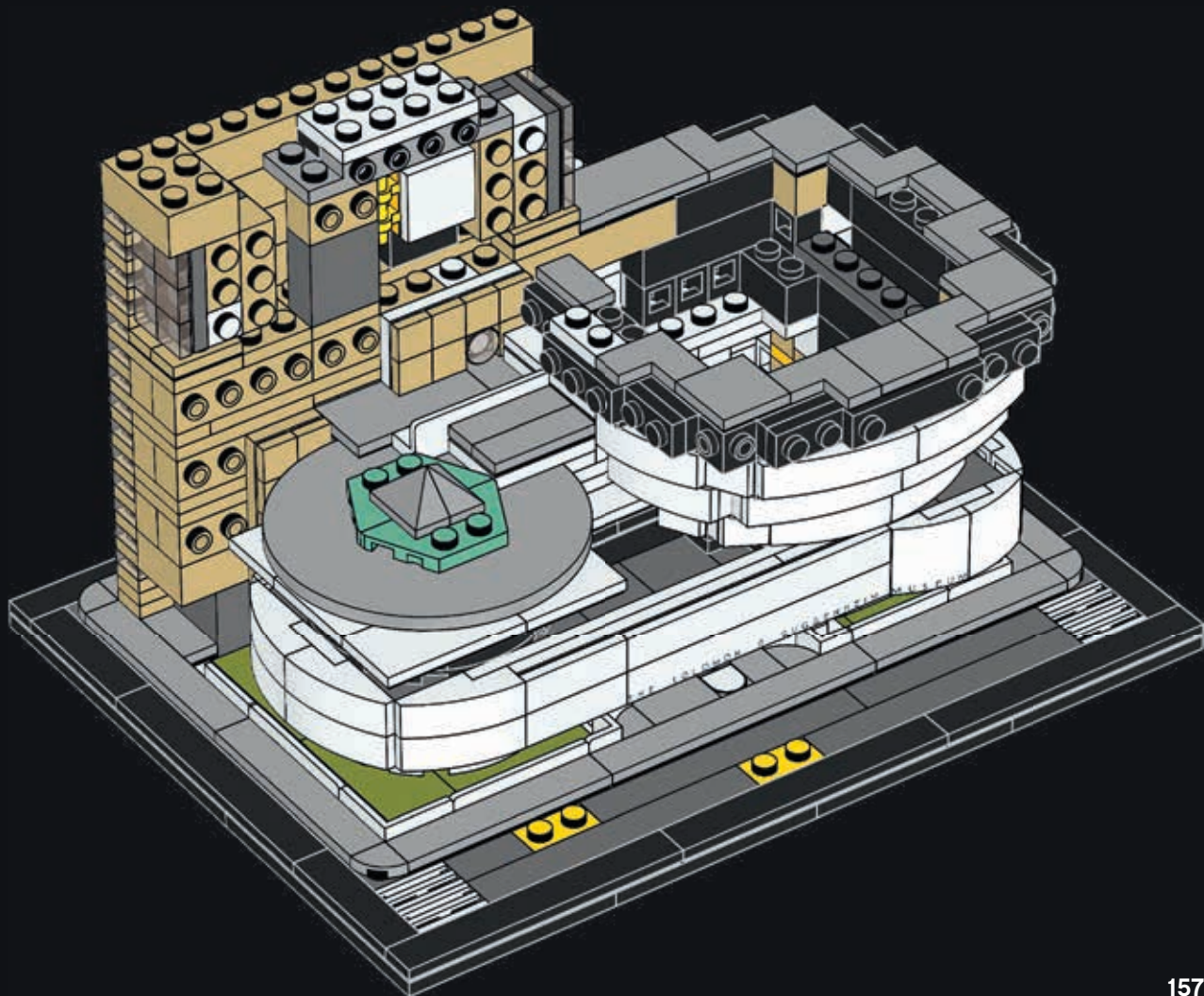

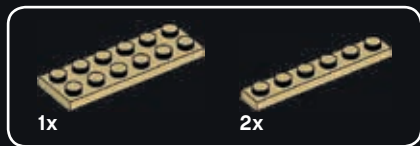

129

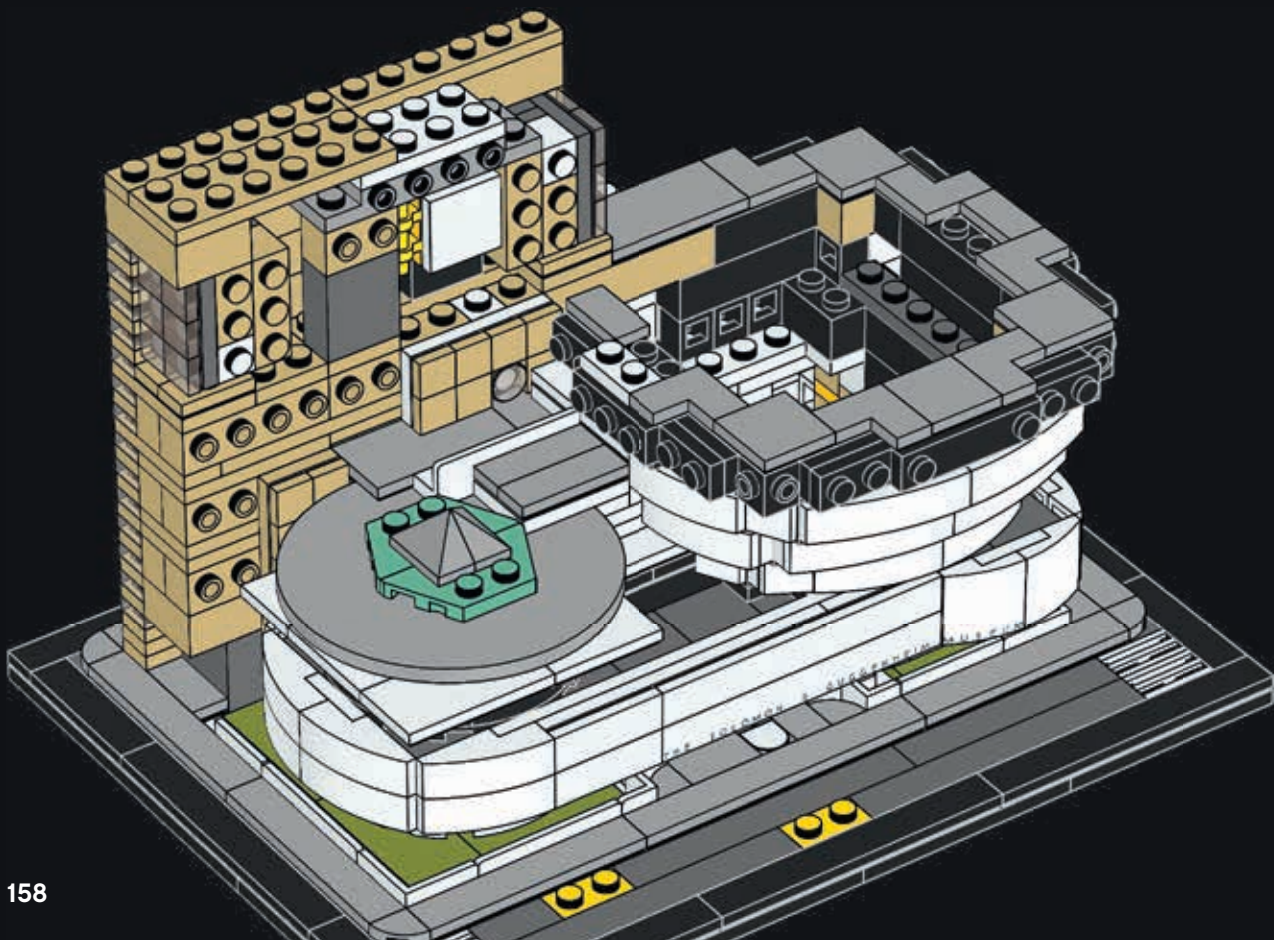



130

1



2



3

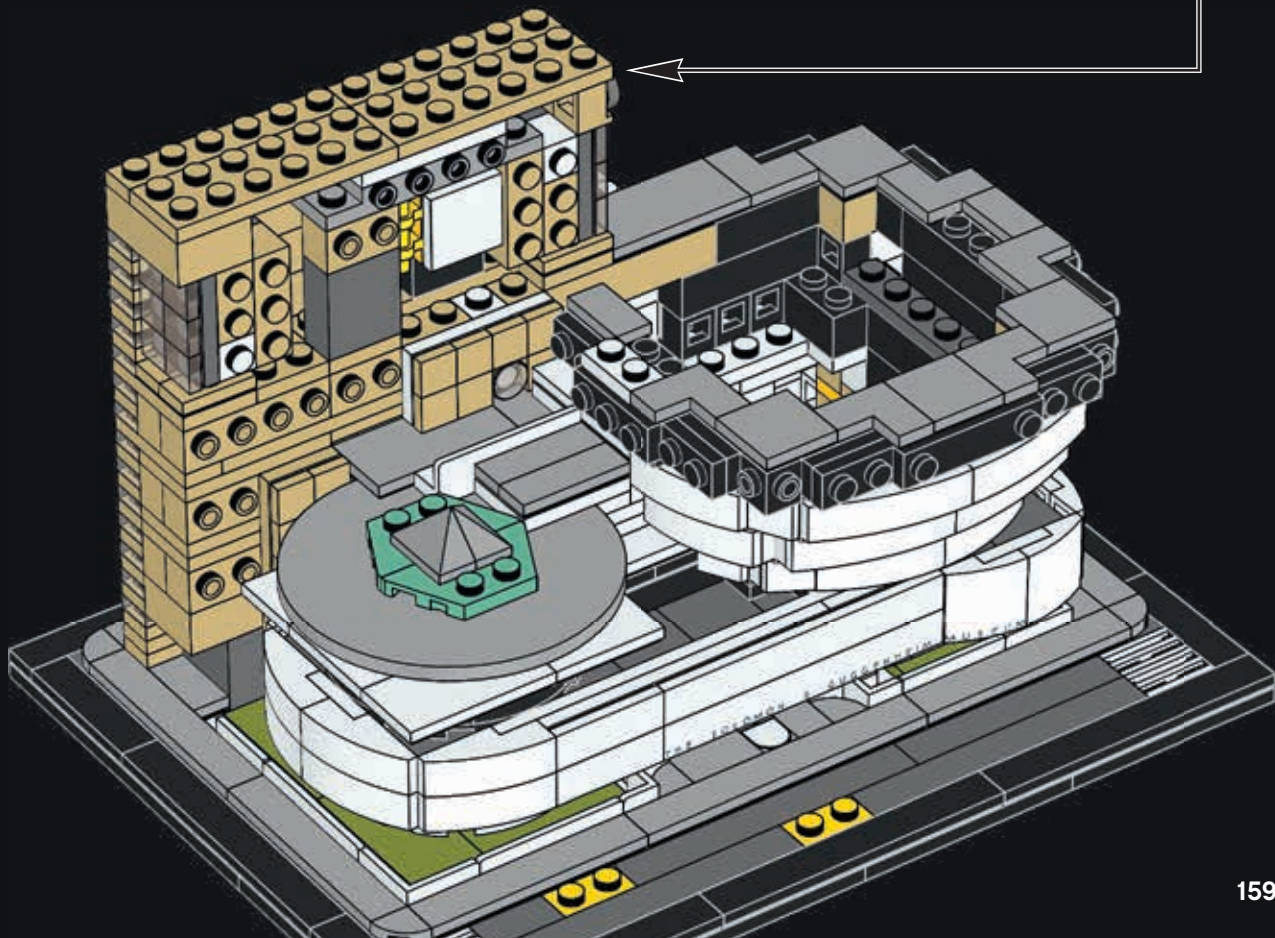

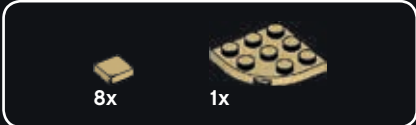

132

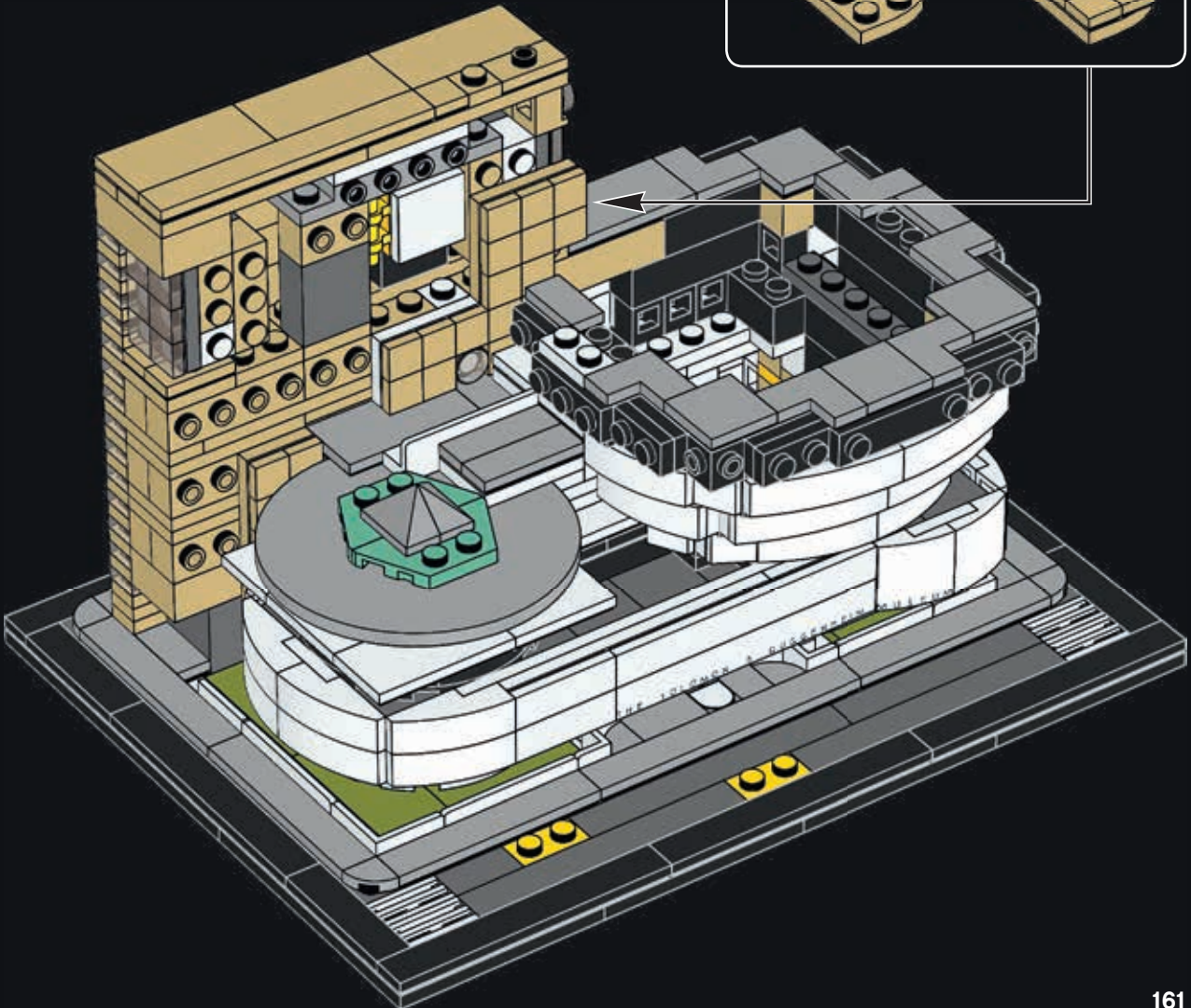
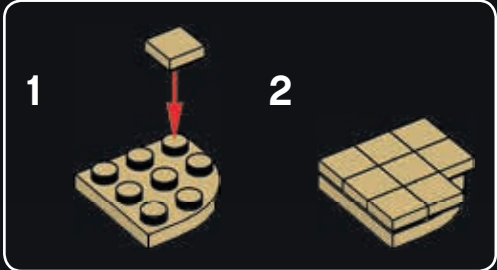



133

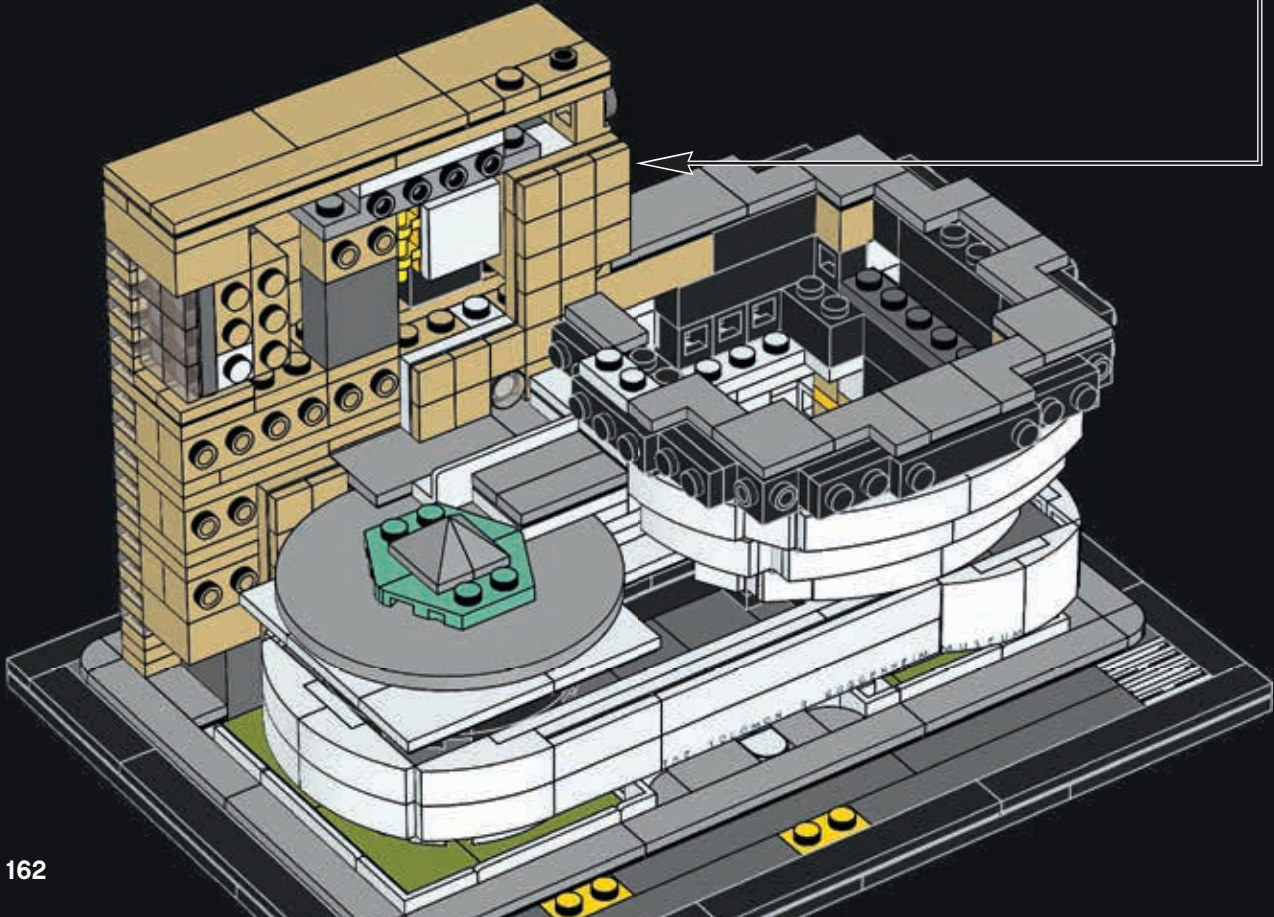
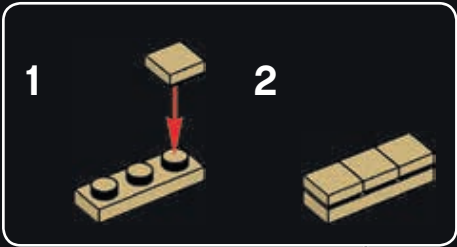



134

1



2

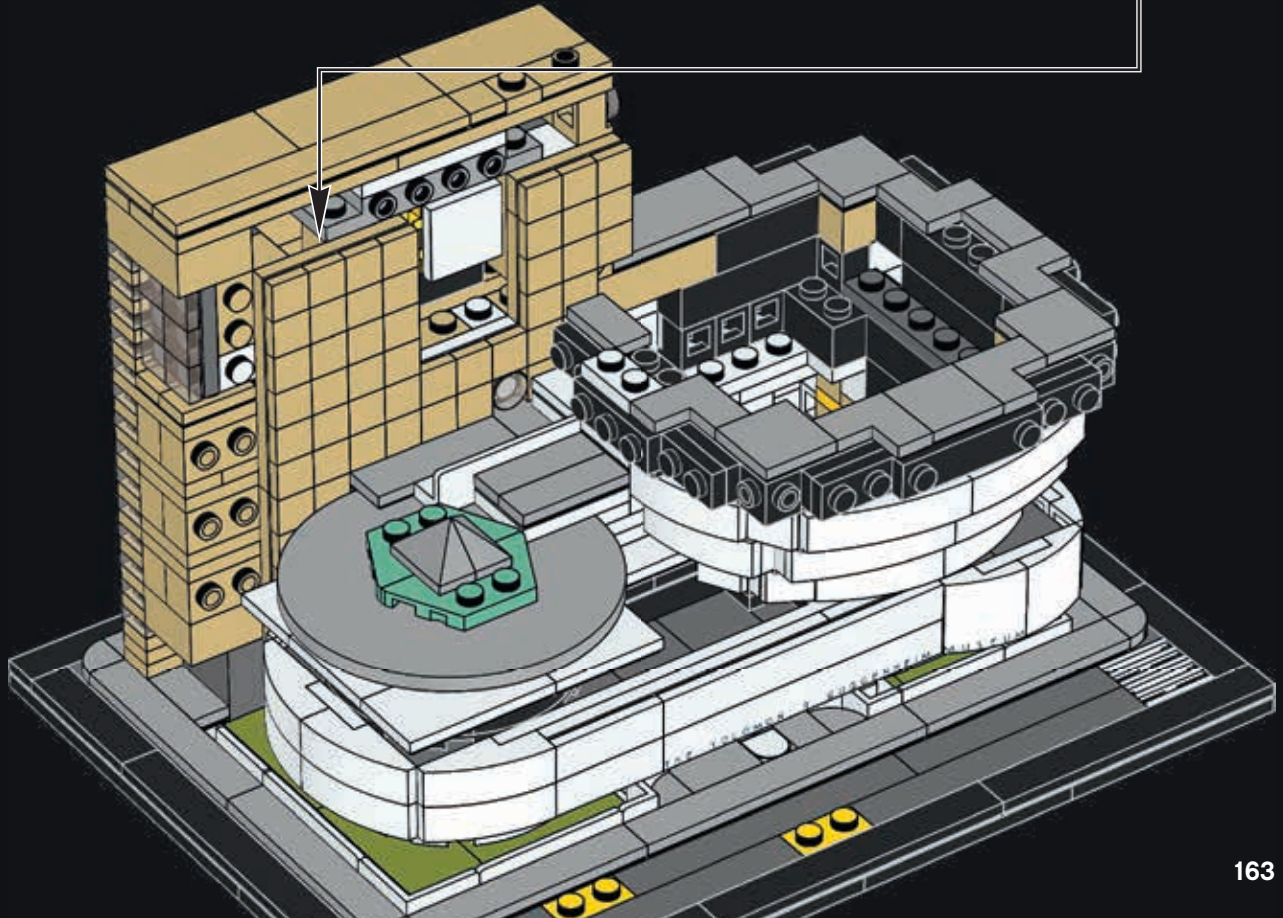



135

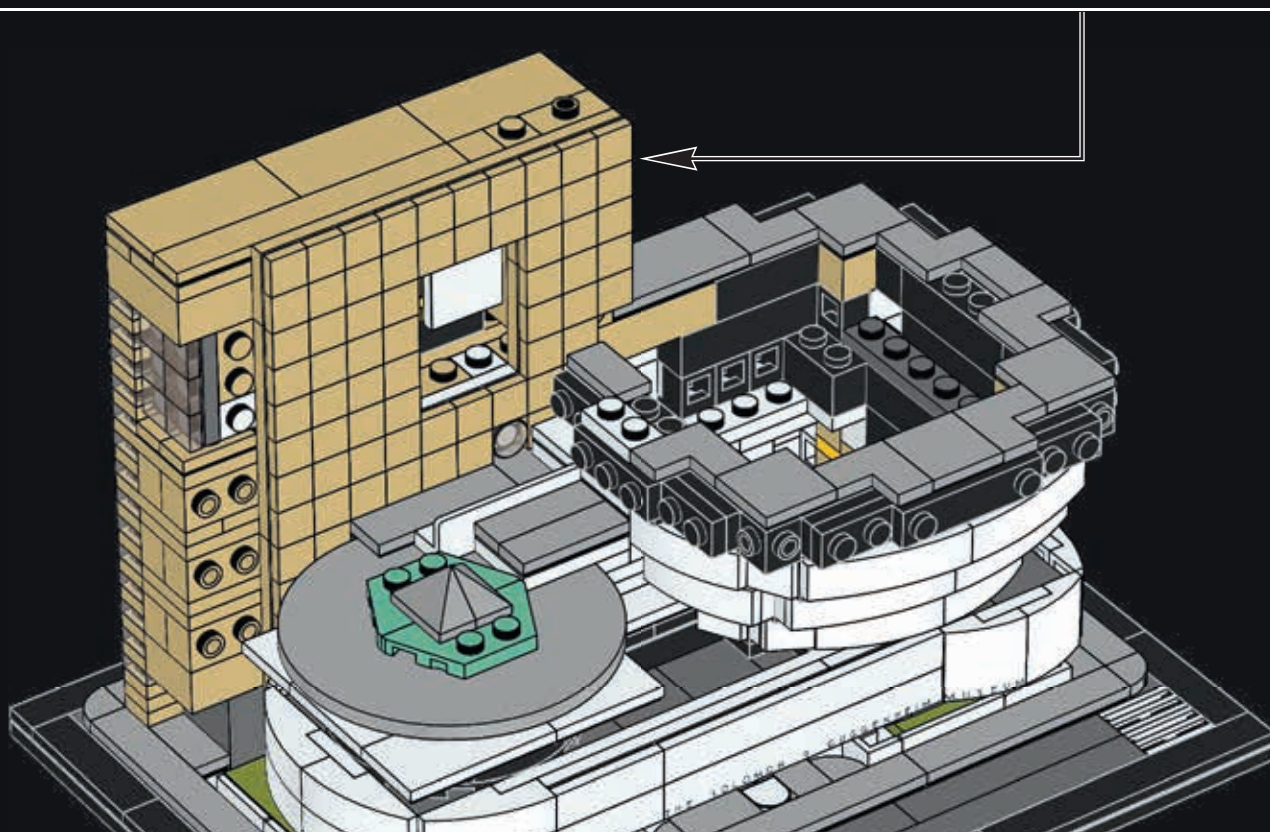
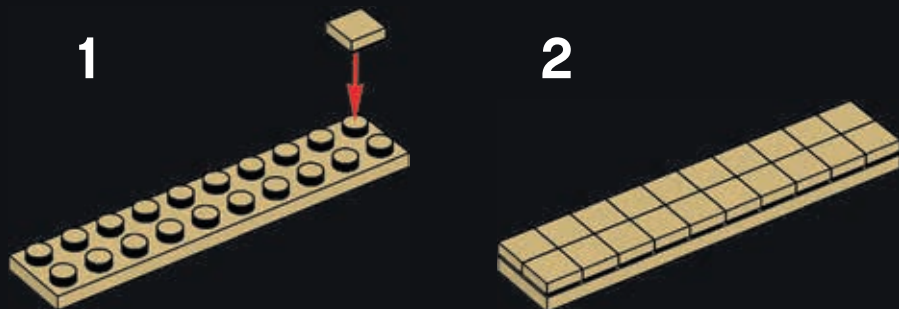

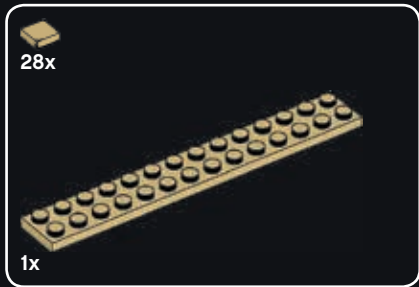

136

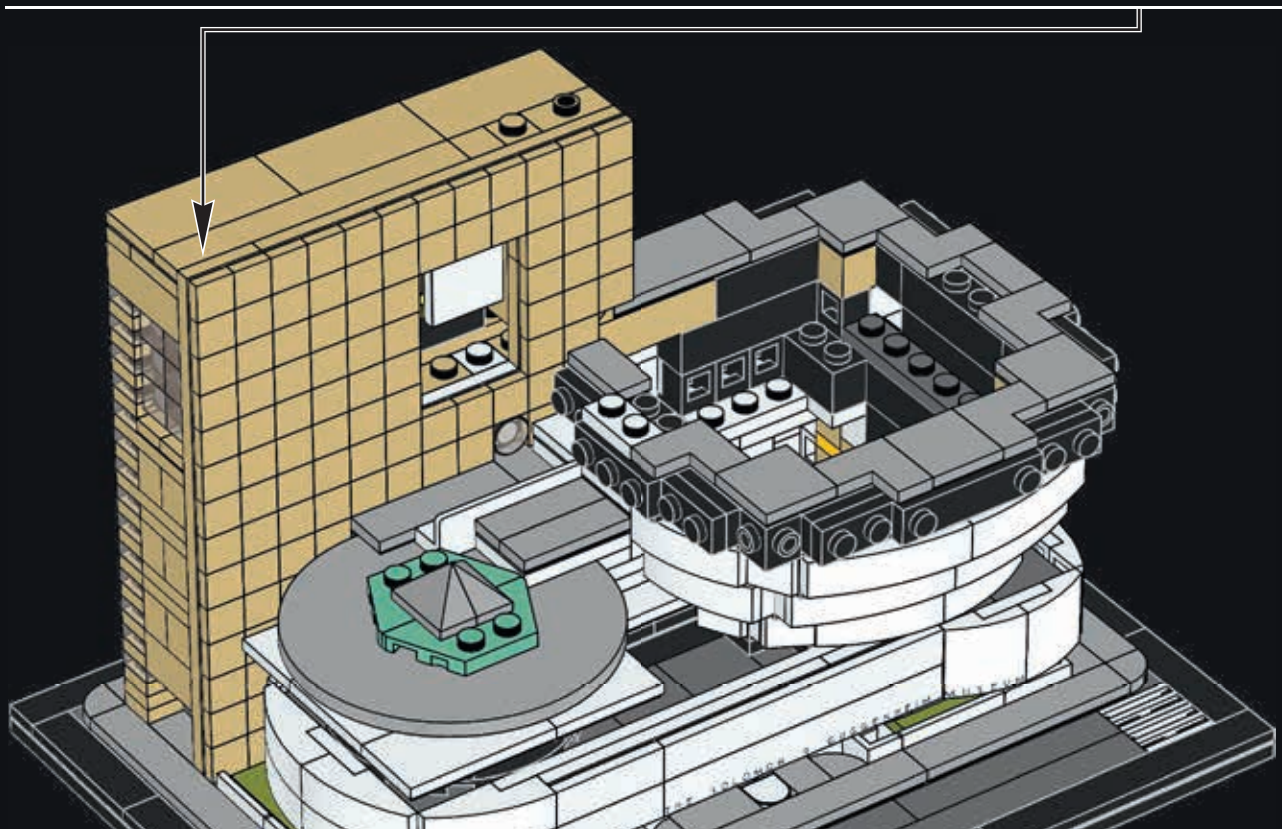
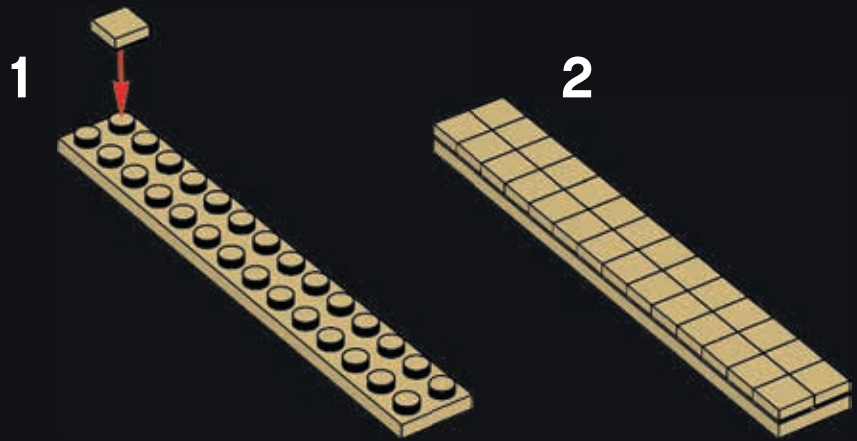



137



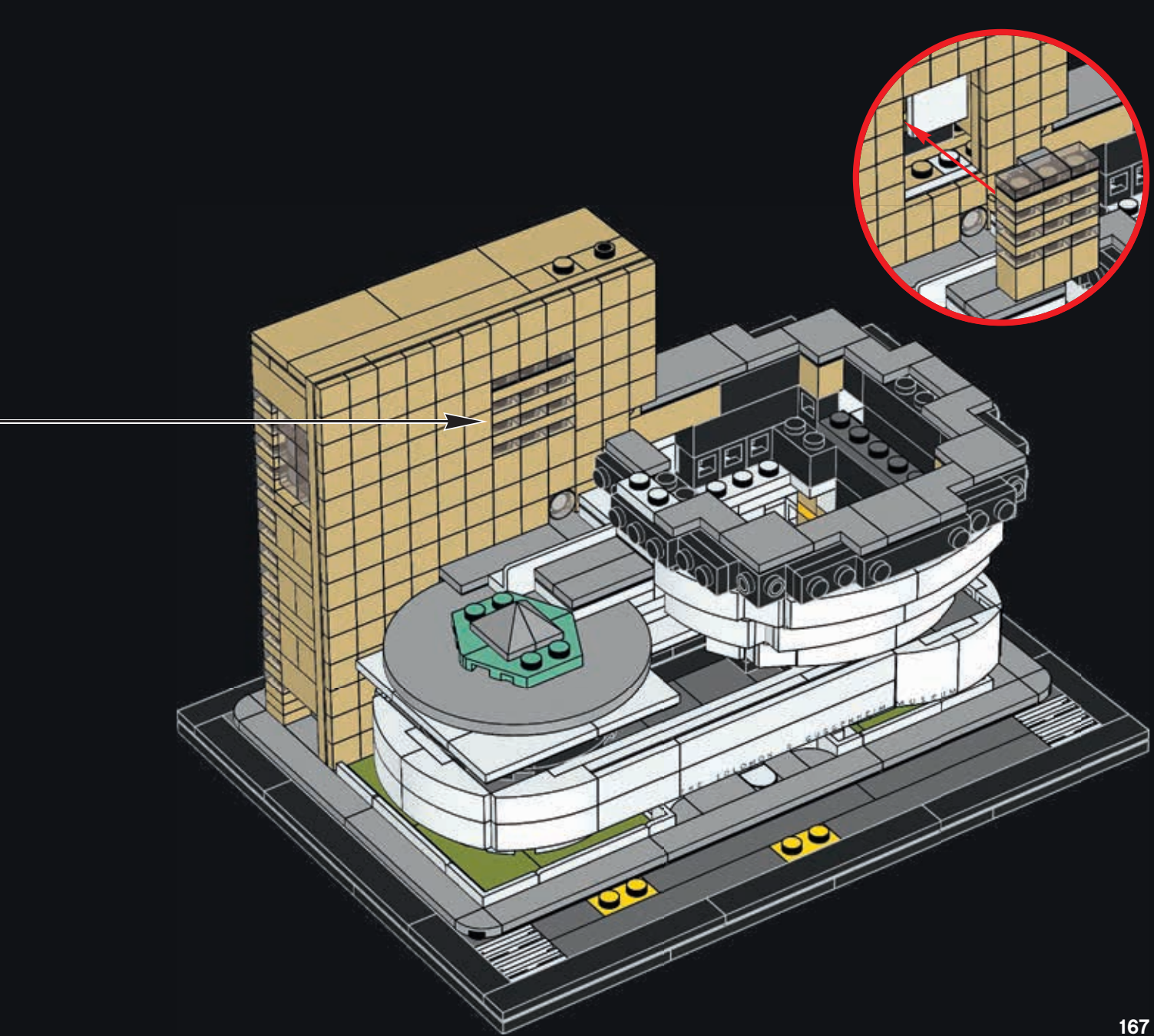

2x

138

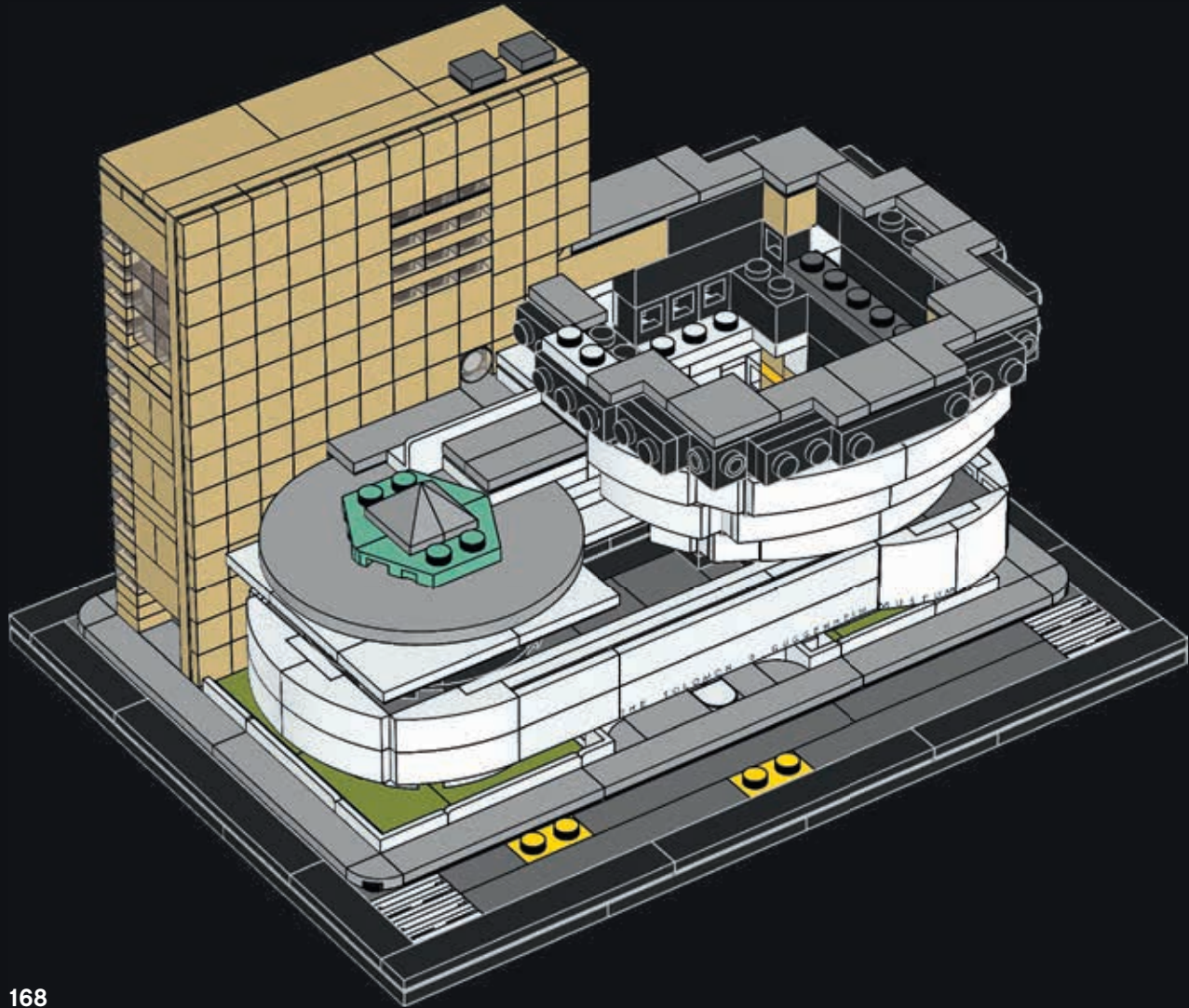



139

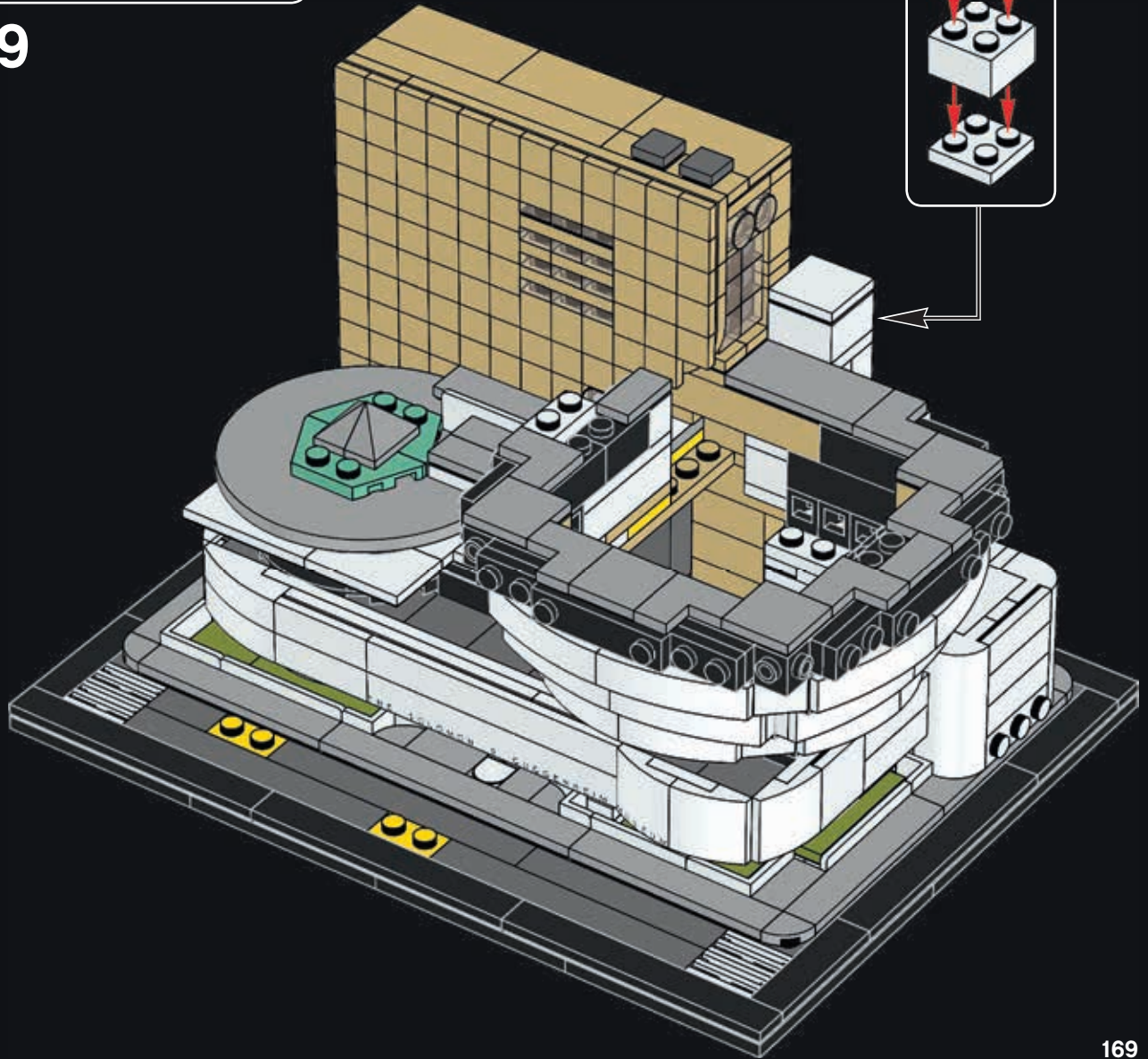



140

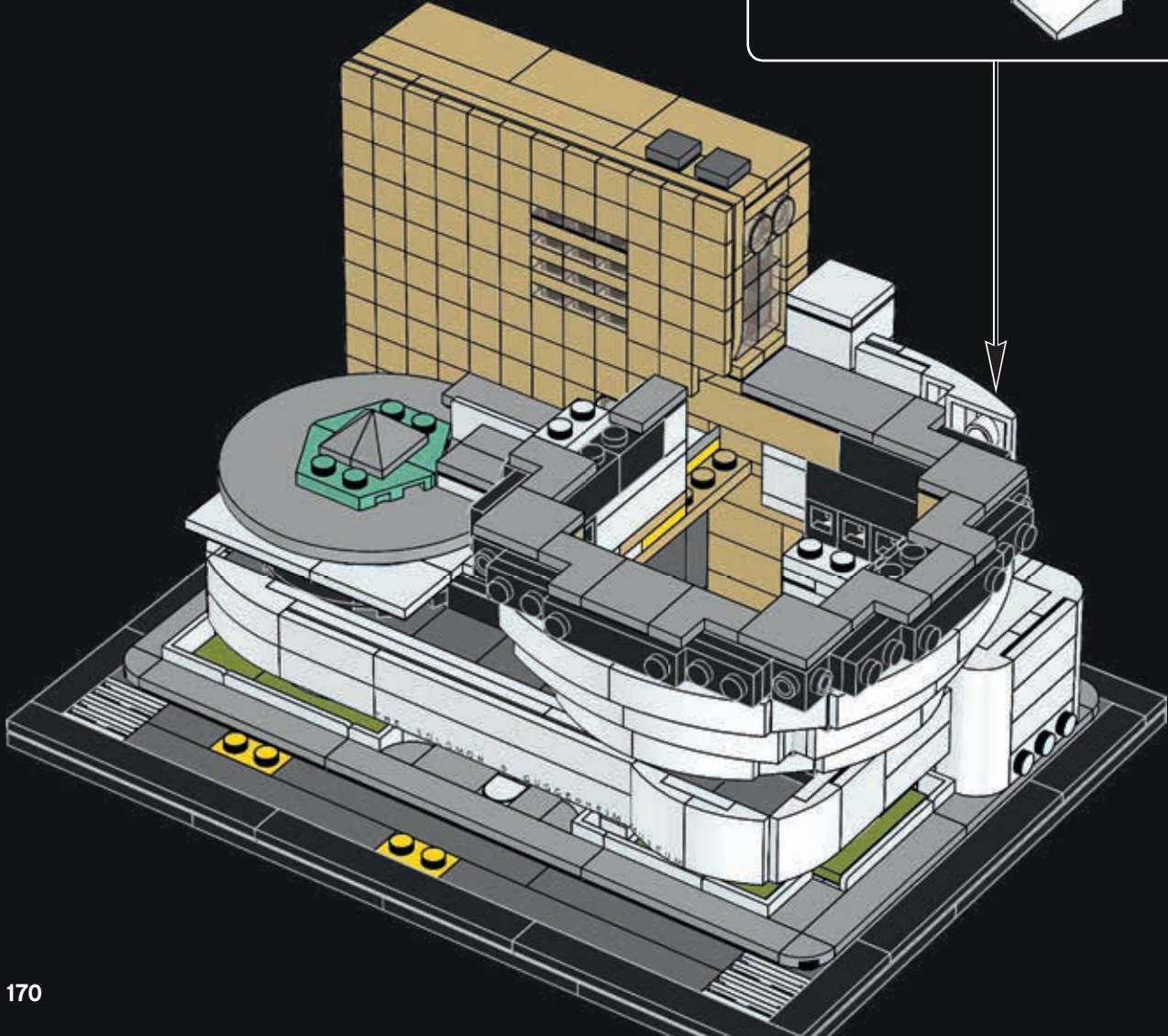
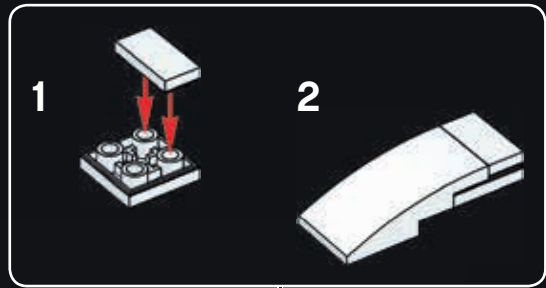



6x

141

A walk up the Guggenheim ramp from the ground floor to the dome is 1,416 feet (431.5 m) long.

La longueur de la rampe du Guggenheim du rez-de-chaussée au dôme est de 431,5 m.

El recorrido por la rampa del Guggenheim desde la planta sótano hasta la cúpula posee una longitud de 431,5 m.

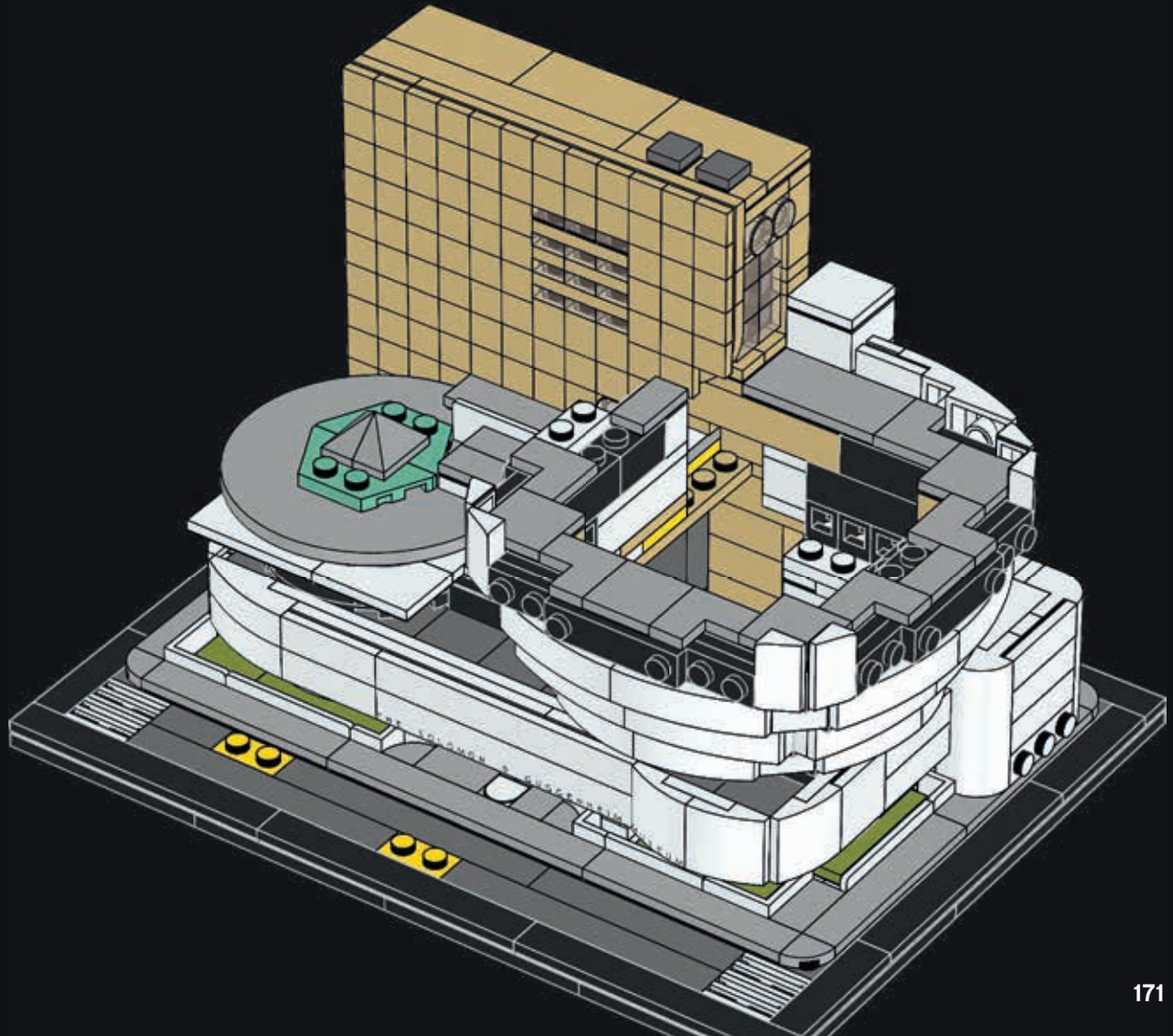



142

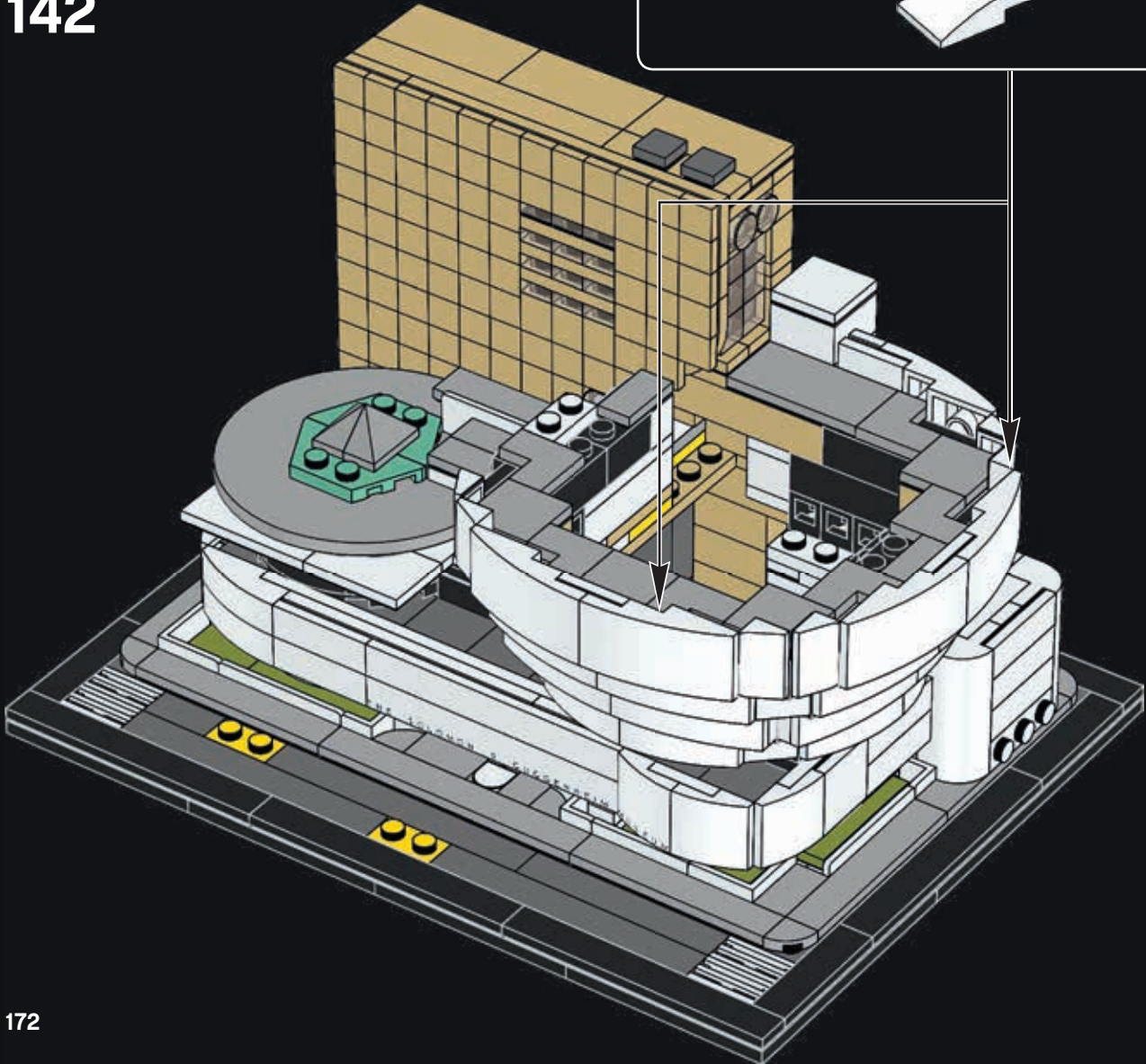



1x



1x

143

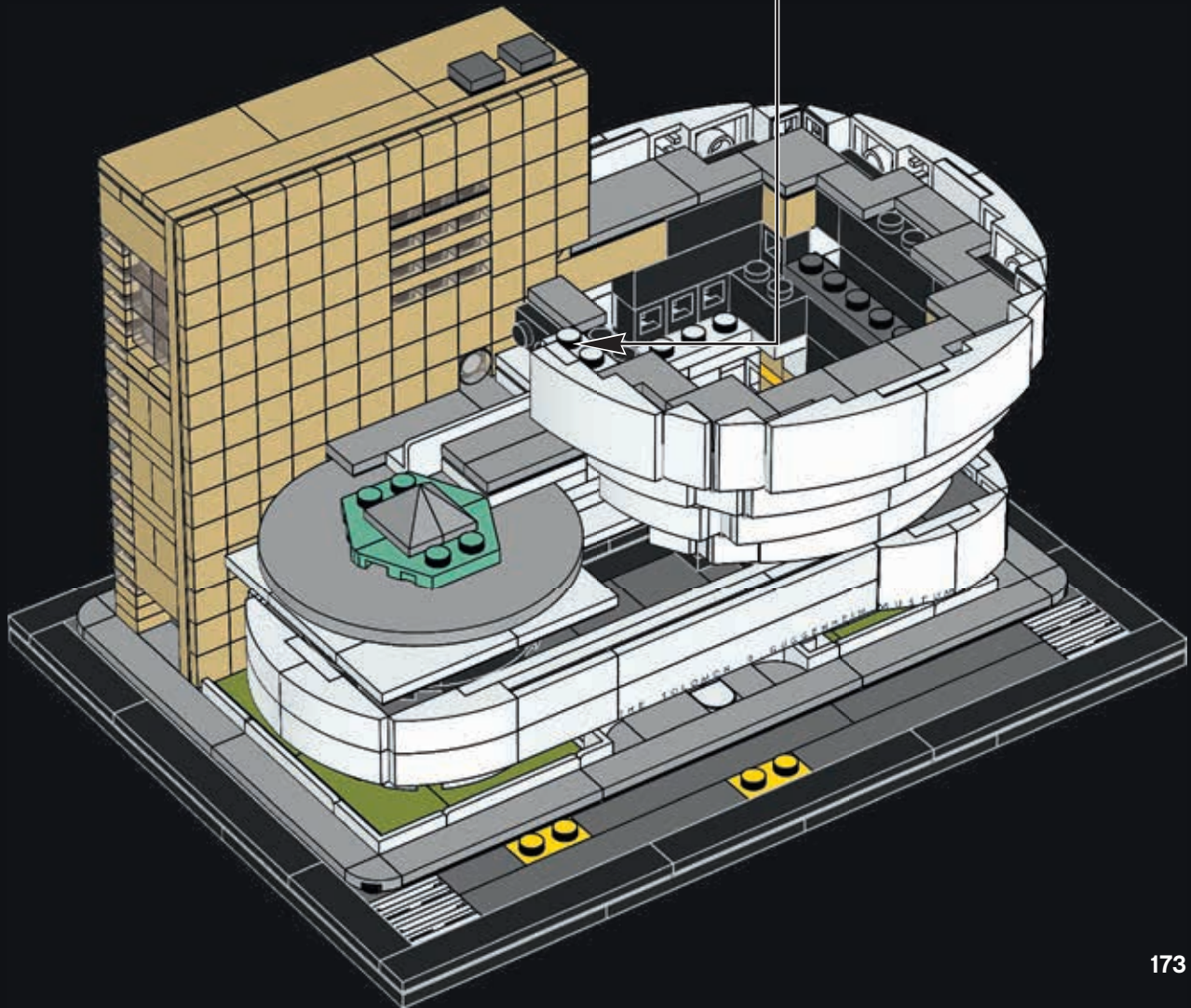



144

1

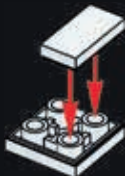

2



3

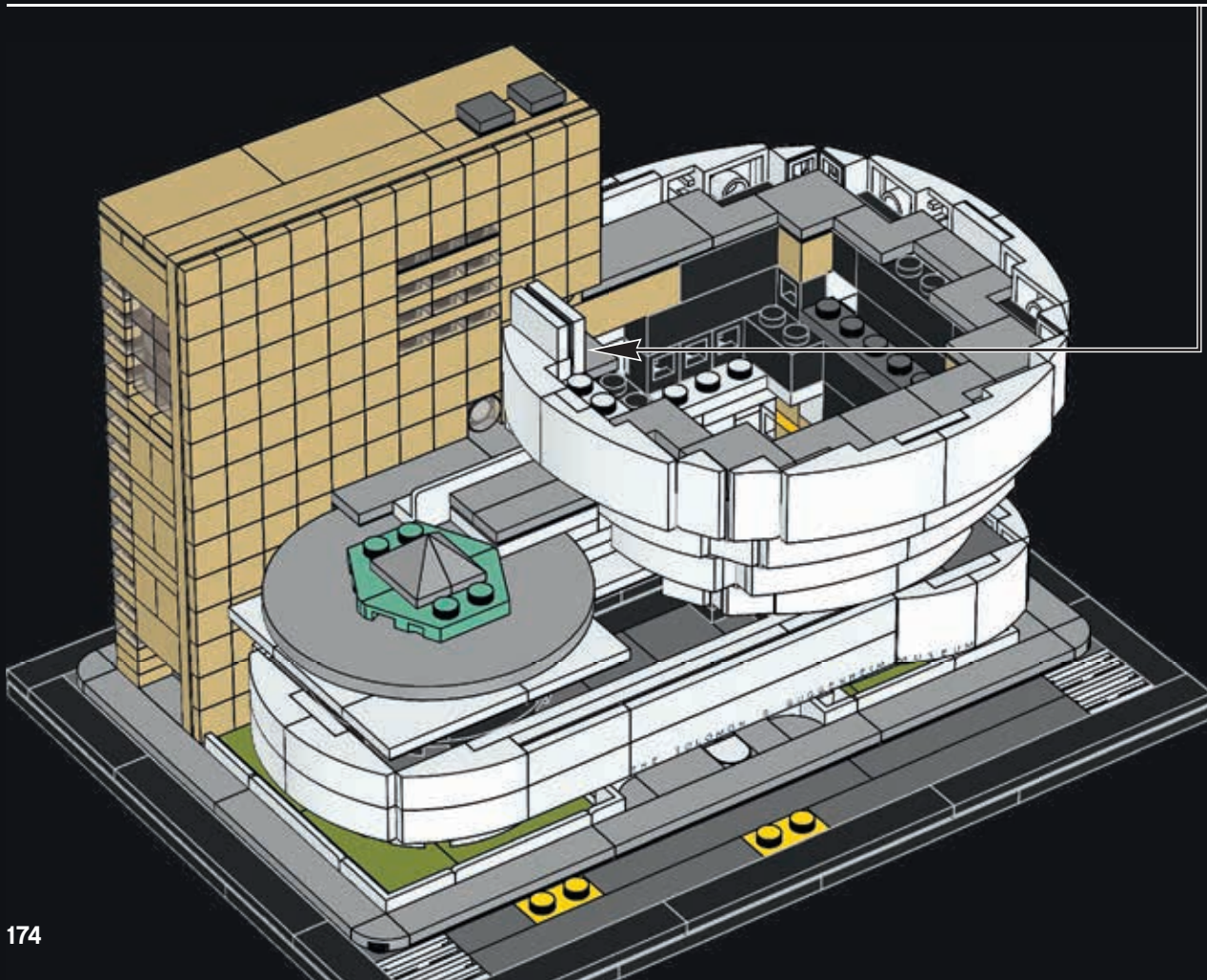

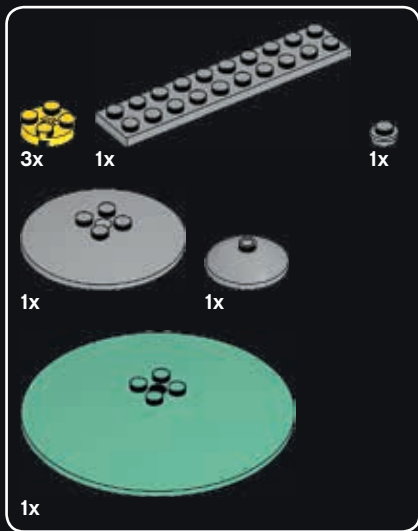

145

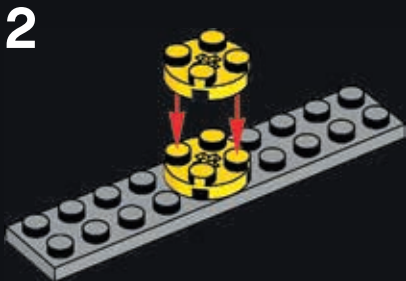

3



4



5

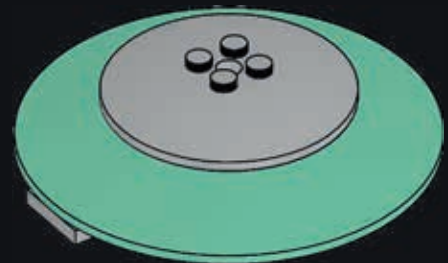

6



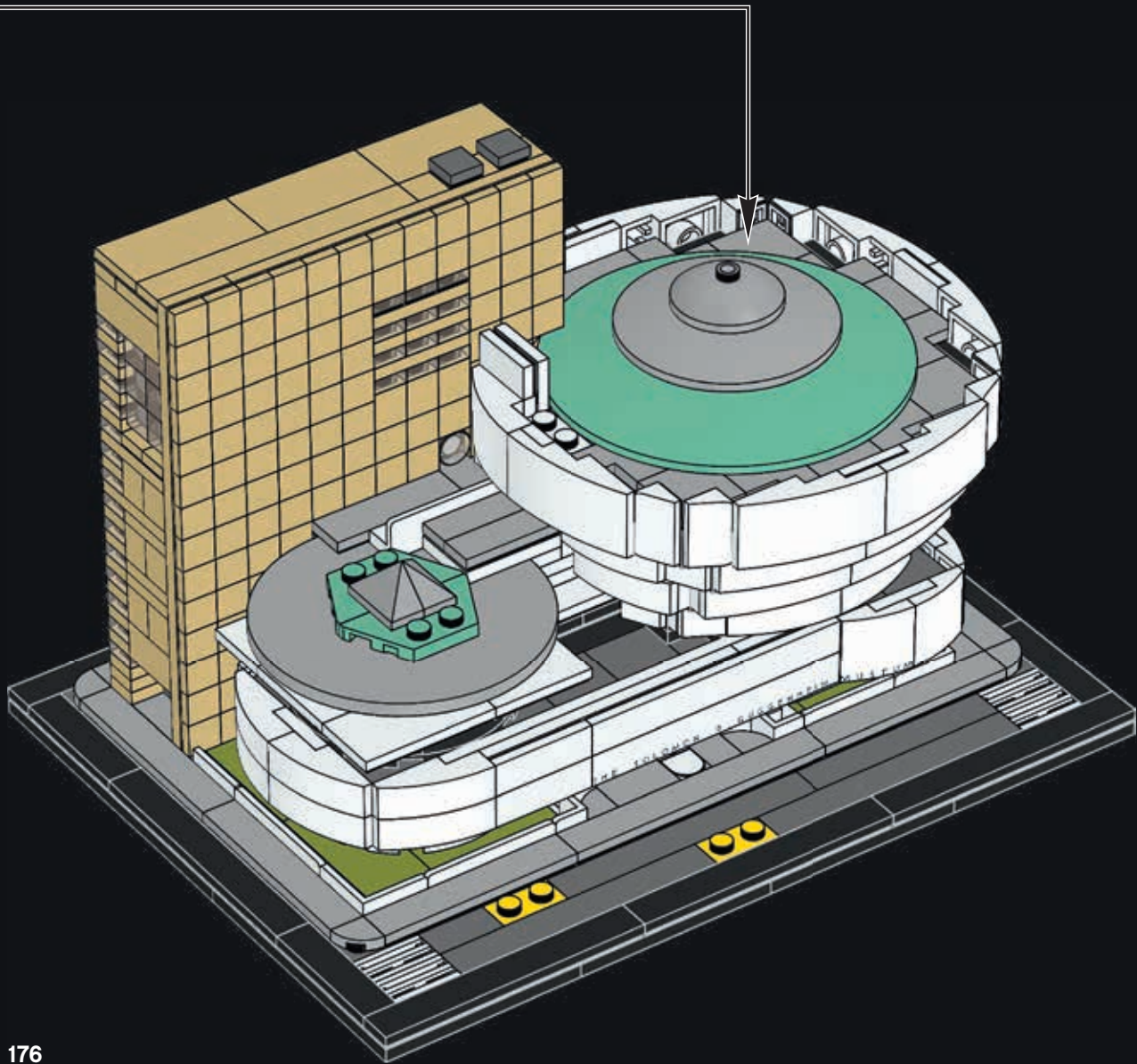



146

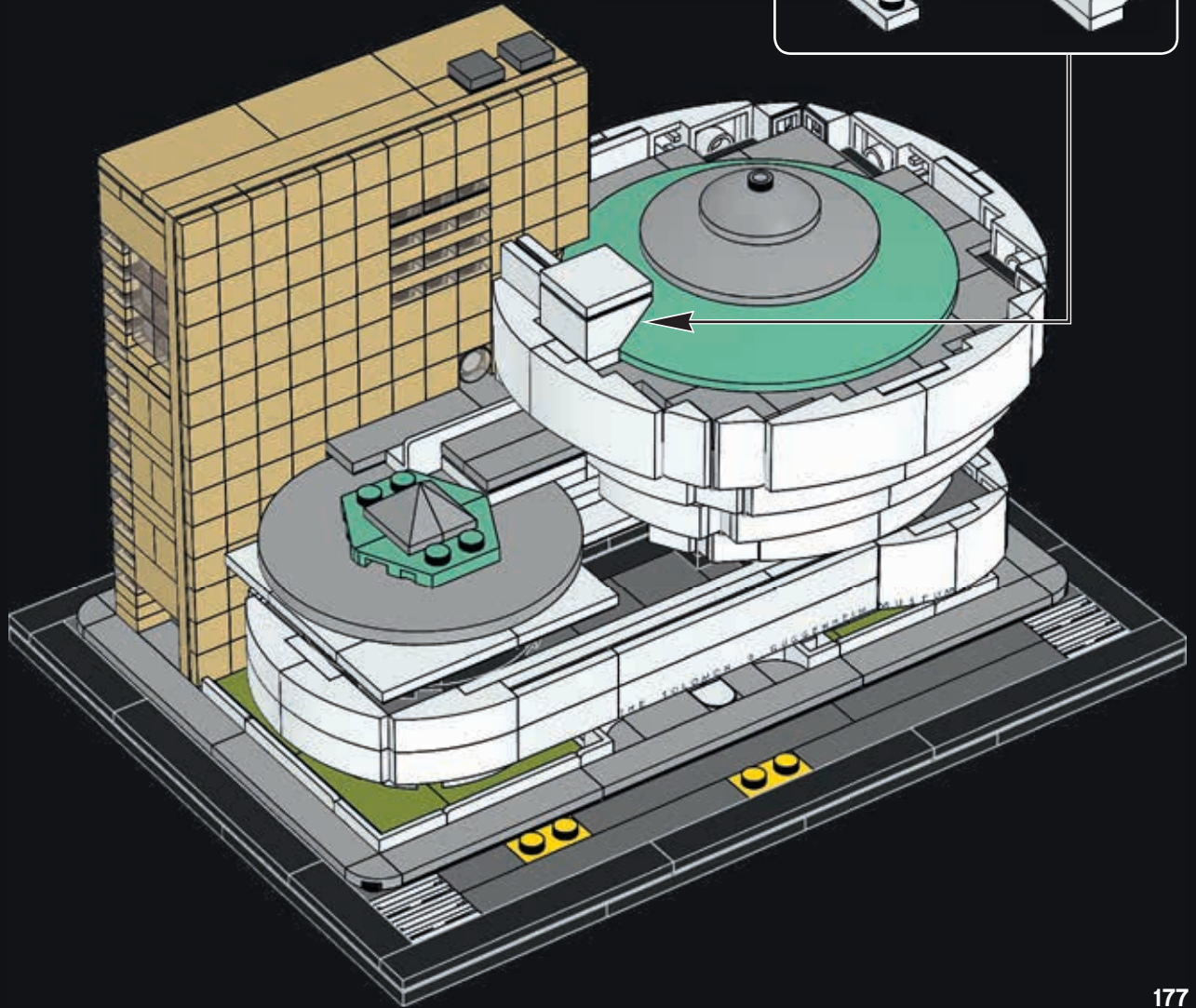
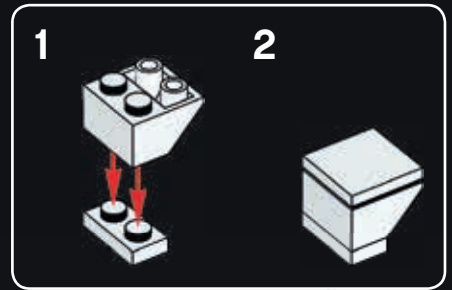

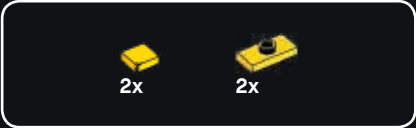

147

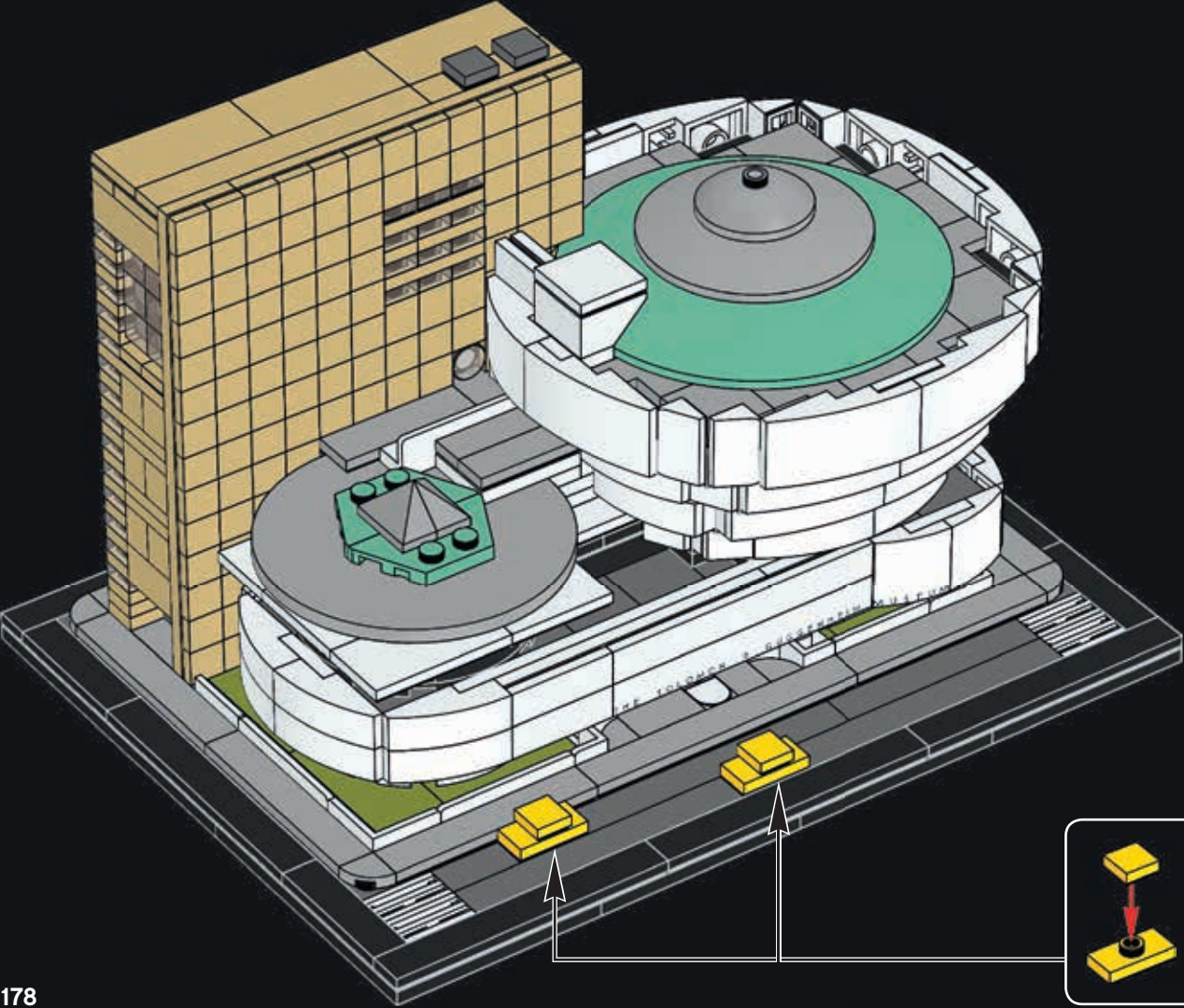



THE SOLOMON R. GUGGENHEIM MUSEUM

SPEED LIMIT 30

ONE WAY

ONE WAY

LEGO® Architecture – do you like it?

The LEGO Group would like your opinion on the new product you have just purchased. Your feedback will help shape the future development of this product series. Please visit:

[LEGO.com/productsurvey](https://www.lego.com/productsurvey)

By completing our short feedback survey, you will be automatically entered into a drawing to win a LEGO® prize.

See website for official rules and details. Open to all countries where not prohibited.

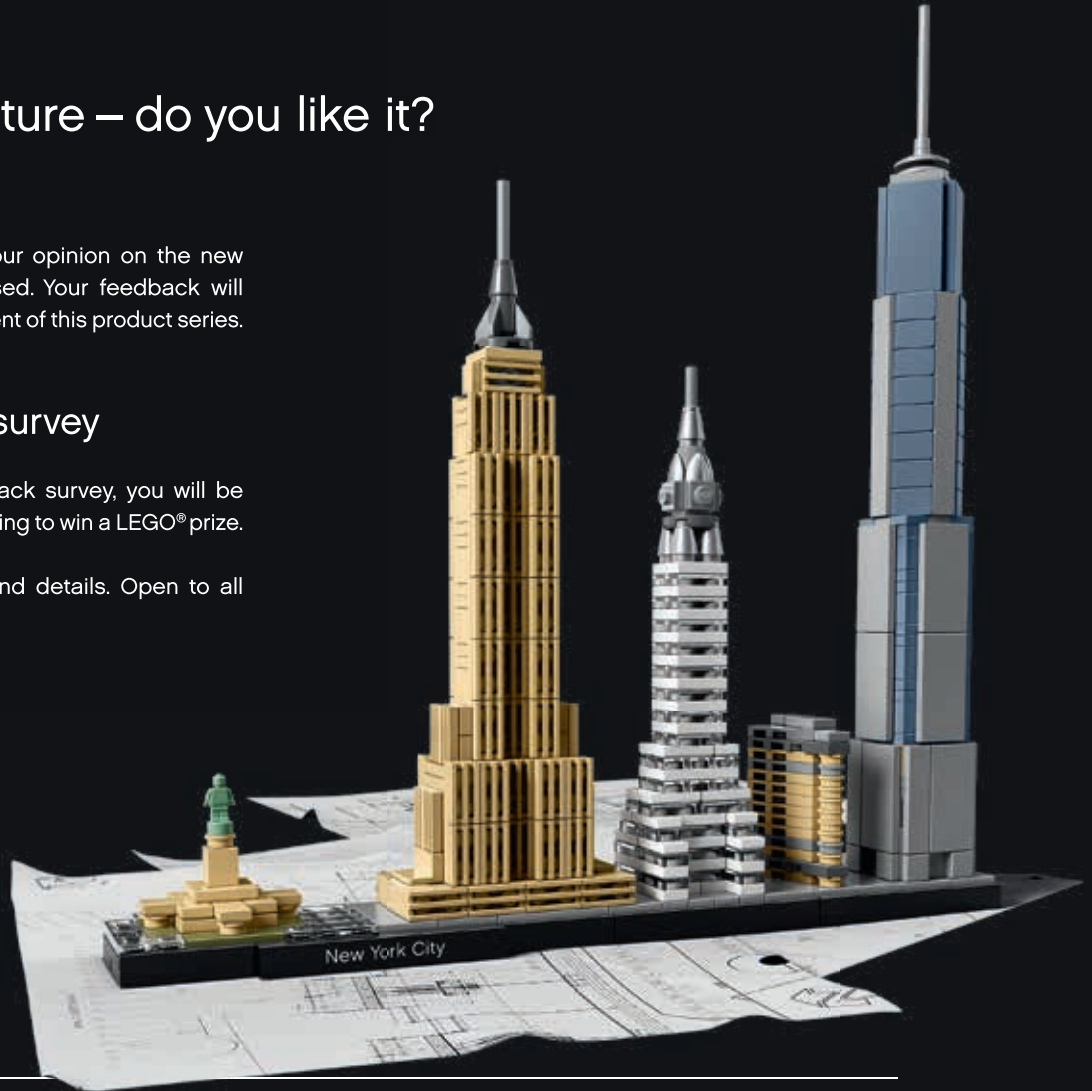

LEGO and the LEGO logo are trademarks of the/sont des marques de commerce du/son marcas registradas de LEGO Group. ©2017 The LEGO Group.

Aimez-vous LEGO® Architecture ?

Le Groupe LEGO aimerait connaître votre opinion sur le produit que vous venez d'acheter. Vos commentaires nous aideront à concevoir les futurs produits de cette gamme. Rendez-vous sur :

[LEGO.com/productsurvey](https://www.lego.com/productsurvey)

En remplissant ce court sondage sur le produit, vous serez automatiquement inscrit à un tirage au sort pour gagner un prix LEGO®.

Consultez le site Web pour obtenir le règlement officiel et les détails. Ouvert à tous les résidents des pays autorisés.

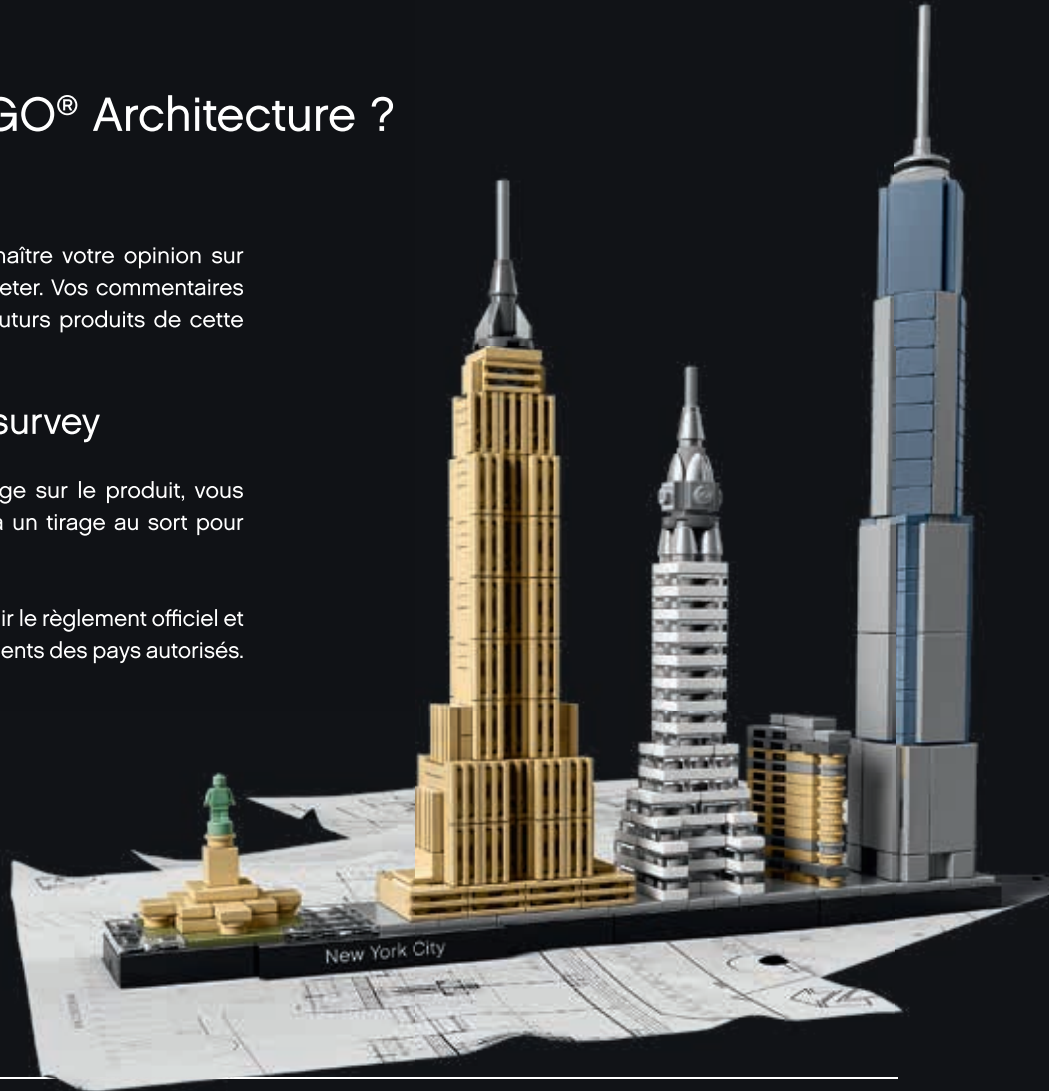

LEGO® Architecture: ¿te gusta?

The LEGO Group quiere conocer tu opinión acerca del nuevo producto que acabas de comprar. Tus comentarios nos ayudarán a dar forma a los futuros productos de esta serie. Visita:

[LEGO.com/productsurvey](https://www.lego.com/productsurvey)

Al rellenar esta breve encuesta de opinión, participarás automáticamente en el sorteo de un producto LEGO®.

Consulta las reglas oficiales y demás información en el sitio web. Válido en todos los países en los que esta actividad no esté prohibida.



LEGO and the LEGO logo are trademarks of the/son des marques de commerce du/son marcas registradas de LEGO Group. ©2017 The LEGO Group.

LEGO® Architecture – then and now

There has always been a natural connection between the LEGO® brick and the world of architecture. Fans who build with LEGO elements instinctively develop an interest in the form and function of the structures they create. At the same time, many architects have discovered that LEGO bricks are the perfect way of physically expressing their creative ideas.

This connection was confirmed in the early 1960s with the launch of the LEGO 'Scale Model' line. It matched the spirit of the age where modern architects were redefining how houses look and people were taking an active interest in the design of their new homes. These sets were designed to be different from the normal, brightly colored LEGO boxes; they also included a book on architecture as a source of inspiration.

Decades later, architect and LEGO fan Adam Reed Tucker revived the idea of expressing architecture using LEGO bricks and in partnership with the LEGO Group,

launched the LEGO Architecture line that we know today. His first models, and the original sets in the current LEGO Architecture series, were interpretations of famous skyscrapers from his hometown of Chicago. Since then LEGO Architecture has developed and evolved, first with well-known buildings from other cities in the United States, and now with iconic structures from Europe, the Middle East and Asia.

The introduction of our LEGO Architecture Studio set echoes the ambitions of the earlier LEGO 'Scale Model' line and widens the potential of the LEGO Architecture series. Now you can enjoy building and learning about specific landmark buildings, or create exciting architectural models from your own fantasy. An inspiring 270-page book, featuring a number of renowned architects from around the world, guides you through the principles of architecture and encourages you in your own creative building.

LEGO® Architecture – Hier et aujourd’hui

Il y a toujours eu une connexion naturelle entre la brique LEGO® et le monde de l'architecture. Les fans qui construisent avec des éléments LEGO développent instinctivement un intérêt pour la forme et la fonction des structures qu'ils créent. De nombreux architectes ont quant à eux découvert que les briques LEGO sont la façon idéale de matérialiser leurs idées de création.

Cette connexion a été confirmée au début des années 1960 avec le lancement de la gamme « Maquettes à l'échelle » LEGO. Cette gamme correspondait à l'esprit de l'époque, alors que les architectes modernes redéfinissaient les maisons, et que les gens s'intéressaient activement à la conception de leur résidence. Ces ensembles originaux étaient conçus pour être différents des boîtes LEGO habituelles aux couleurs vives, et incluaient aussi « un livret d'architecture » comme source d'inspiration.

Quelques décennies plus tard, l'architecte et fan de LEGO Adam Reed Tucker a fait revivre l'idée d'exprimer l'architecture en utilisant des briques LEGO. En partenariat avec le Groupe LEGO, il lança la gamme LEGO Architecture que nous connaissons aujourd'hui.

Ses premiers modèles, et les ensembles originaux de la gamme LEGO Architecture actuelle, étaient des interprétations de célèbres gratte-ciel de sa ville natale de Chicago. La gamme LEGO Architecture a depuis évolué et s'est élargie, tout d'abord avec des bâtiments célèbres d'autres villes des États-Unis, puis avec de célèbres monuments d'Europe, du Moyen-Orient et d'Asie.

L'introduction de notre ensemble LEGO Architecture Studio fait écho aux ambitions de la précédente gamme « Maquettes à l'échelle » LEGO et accroît le potentiel de la gamme LEGO Architecture. Vous pouvez maintenant découvrir et construire des monuments célèbres ou créer de passionnants modèles architecturaux nés de votre imagination. Un livret d'inspiration de 270 pages, présentant plusieurs architectes célèbres du monde entier, vous guide parmi les principes de l'architecture et vous encourage dans votre propre construction créatrice.

LEGO® Architecture: entonces y ahora

Siempre ha existido una conexión natural entre el brick LEGO® y el mundo de la arquitectura. Los fans que construyen con elementos LEGO desarrollan instintivamente un interés por la forma y las funciones de las estructuras que crean. Al mismo tiempo, muchos arquitectos han descubierto que los bricks LEGO son una forma perfecta de expresar físicamente sus ideas creativas.

Esta relación se confirmó a principios de la década de 1960, con el lanzamiento de la línea «Scale Model» de LEGO. Encajaba bien con el espíritu de la época: un tiempo en el que los arquitectos modernos redefinían el aspecto de las casas y la gente se interesaba cada vez más por el diseño de su nuevo hogar. Los sets se diseñaron para que se diferenciaban de los normales, que se comercializaban en cajas de brillantes colores, e incluían un libro sobre la arquitectura que proporcionaba inspiración a sus usuarios.

Décadas más tarde, el arquitecto y fan de LEGO Adam Reed Tucker reavivó la idea de expresar la arquitectura usando bricks LEGO y, en colaboración con The LEGO Group, lanzó la línea LEGO Architecture que hoy conocemos.

Sus primeros modelos, y los sets originales de la actual serie LEGO Architecture, eran interpretaciones de los rascacielos más famosos de su ciudad natal, Chicago. Desde entonces, LEGO Architecture se ha desarrollado y ha evolucionado, primero incorporando edificios célebres de otras ciudades de Estados Unidos y, ahora, estructuras emblemáticas de Europa, Oriente Próximo y Asia.

La introducción del set LEGO Architecture Studio recupera las ambiciones de la antigua línea «Scale Model» de LEGO y amplía el potencial de la serie LEGO Architecture. Hoy puedes disfrutar mientras construyes y aprendes sobre edificios célebres, o crear tus propios modelos arquitectónicos a partir de tu imaginación. Un instructivo libro de 270 páginas con materiales creados por arquitectos internacionales de gran reputación te guiará a través de los principios de la arquitectura y te animará a dar tus primeros pasos en el mundo de la construcción creativa.



21050
Studio

References

Photo credits:

www.shutterstock.com

©The Solomon R. Guggenheim

Foundation, New York

p. 2, 7, 9, 10

For further information please visit:

www.guggenheim.org

Références

Crédits photos :

www.shutterstock.com

©The Solomon R. Guggenheim

Foundation, New York

p. 2, 7, 9, 10

Pour en savoir plus, veuillez vous rendre sur :

www.guggenheim.org

Referencias

Fotografías:

www.shutterstock.com

©The Solomon R. Guggenheim

Foundation (Nueva York)

p. 2, 7, 9, 10

Para más información, visita:

www.guggenheim.org

Customer Service
Kundenservice
Service Consommateurs
Servicio Al Consumidor
LEGO.com/service or dial



00800 5346 5555: 

1-800-422-5346: 

Celebrate the world of architecture
Célébrez le monde de l'architecture
Celebra el mundo de la arquitectura

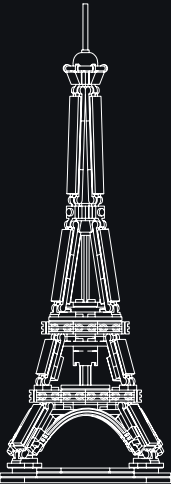

21019
The Eiffel Tower
La tour Eiffel
La torre Eiffel

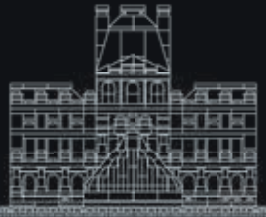

21024
Louvre

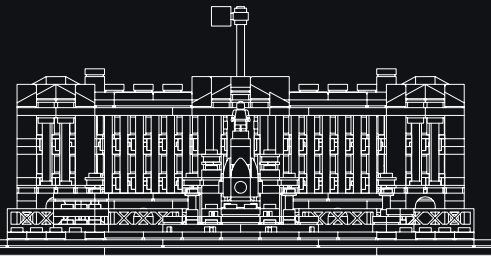

21029
Buckingham Palace
Le palais de Buckingham
Palacio de Buckingham



21026
Venice
Venice
Venecia



21027
Berlin
Berlin



21028
New York City
New York
Nueva York

and collect all the models
et collectionnez tous les modèles
y colecciona todos los modelos



21030
United States Capitol Building
Le Capitole des États-Unis
Edificio del Capitolio de Estados Unidos

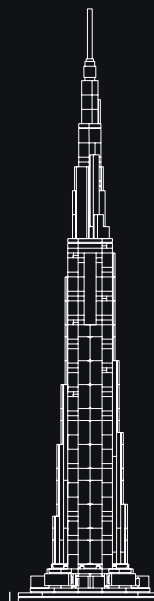

21031
Burj Khalifa

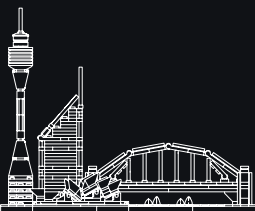

21032
Sydney
Sidney



21033
Chicago

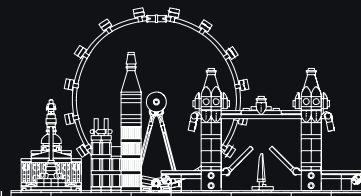

21034
London
Londres

 3x
6131655

 3x
4504369

 7x
4558952

 7x
307001

 16x
302401

 5x
623101

 6x
4547489

 4x
241201

 3x
306901

 16x
302301

 2x
6146215

 8x
300401

 1x
6034044

 3x
4121932

 8x
302201

 4x
6013866

 4x
306801

 3x
6047220

 1x
366001

 1x
300301

 2x
6181753

 7x
6046979

 1x
6139694

 7x
362301

 11x
4249112

 7x
4558168

 4x
362201

 1x
6182352

 1x
6132212

 3x
6156667

 4x
302101

 2x
300201

 3x
243101

 3x
301001

 11x
371001

 10x
6045936

 4x
6061047

 4x
302001

 2x
4560178

 6x
6031947

 2x
608101

 1x
300101

 2x
366601

 1x
617901

 1x
4215470

 3x
6109817

 2x
379501

 1x
416201

 1x
6182355

 2x
303401

 3x
244501

 1x
4119227

 2x
4118793

 19x
4159553

 13x
4113915

 103x
4125253

 1x
6029889

 5x
6092587

 7x
6024495

 4x
4113917

 1x
6061575

 9x
4121921

 6x
4162465

 8x
4118790

 1x
4159739

 4x
4201062

 2x
4113916

 1x
4543858

 4x
4114309

 3x
6122047

 5x
4114319

 3x
4124067

 5x
4112982

 3x
4113993

 1x
4544139

 6x
4159774

 1x
4114001

 1x
4113988

 2x
4249019



1x
6036487



3x
307024



4x
403224



4x
6092583



12x
302324



1x
4140587



4x
302224



1x
4243817



23x
407026



12x
302326



4x
6092585



6x
300426



7x
6138173



2x
300326



12x
362326



4x
6187587



4x
6187572



7x
4599499



4x
243126



12x
4162443



3x
301026



1x
4159550



1x
379526



8x
416226



4x
303626



4x
303626



4x
303626



4x
303326



4x
4565323



1x
4654448



3x
6079000



15x
6038458



23x
6030982



2x
6187591



1x
6187588



1x
4211525



6x
6176433



2x
6075075



8x
4211414



1x
6123809



4x
4211413



8x
6065824



1x
6070564



8x
4211429



4x
4558169



3x
4560183



8x
4211549



1x
4160560



1x
4211796



3x
4211008



1x
6102575



1x
4211481



1x
4625582



2x
6133611



1x
6047015



1x
4211462



2x
4210848



7x
4210978



4x
4211052



6x
4211055



8x
4211043



4x
4211056



1x
4210651



3x
4211008



4x
4210998



2x
6133611



1x
6047015



6x
6016488



1x
6016484

