



# CLASSIC

11015





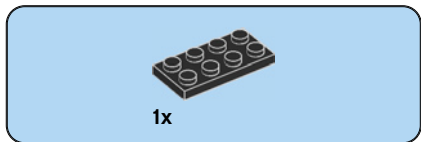
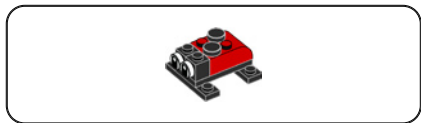

**1**

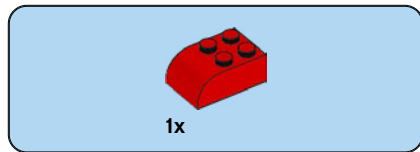
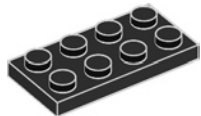

**2**

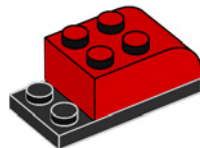

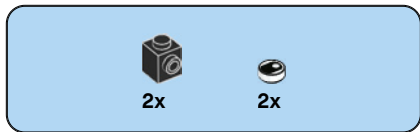

3

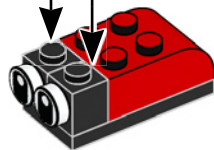
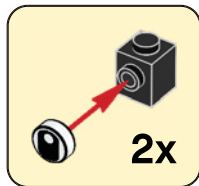

4

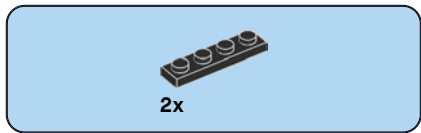

4

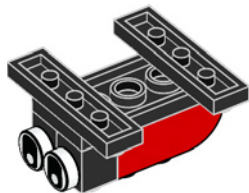

5

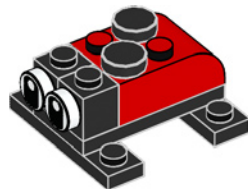



1x

**1**

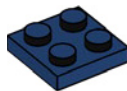



2x

2

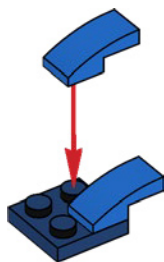



1x

**3**

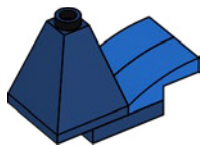

**8**





1x

4

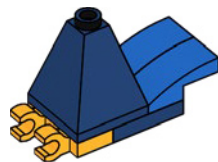

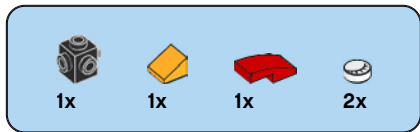

5

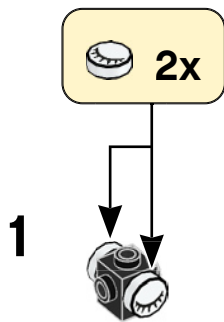

2



3



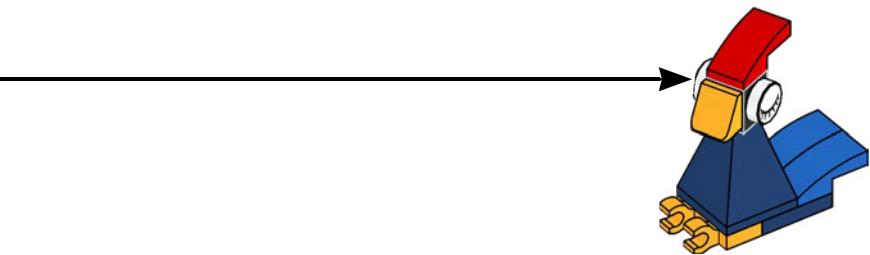

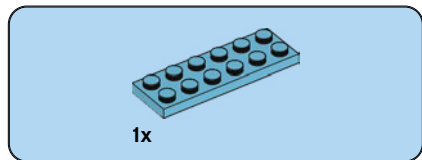
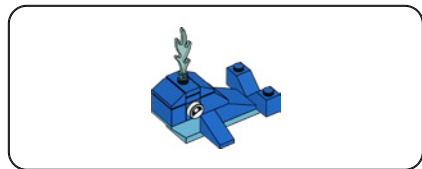

**1**

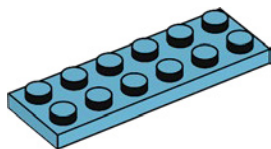

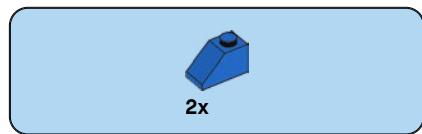

2

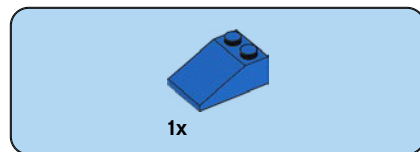
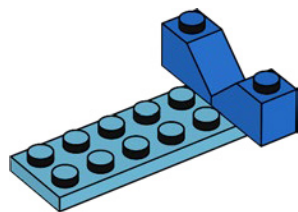

3

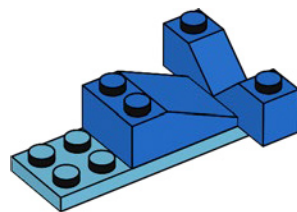

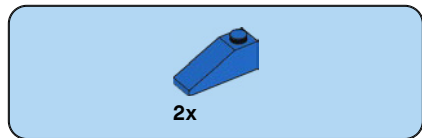

4

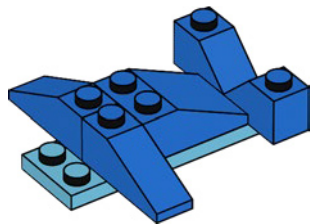

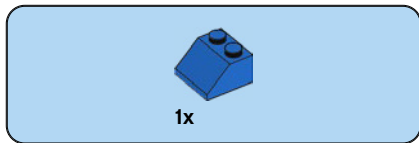

5

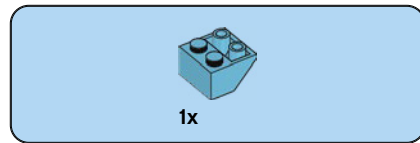
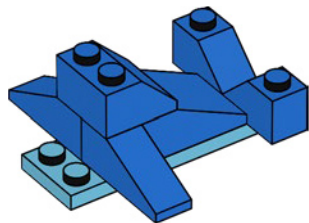

6

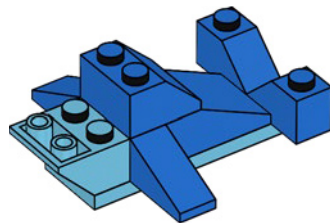



1x



1x

7

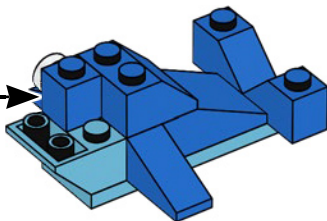
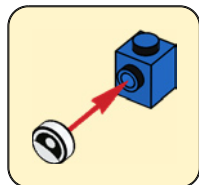





1x



1x

8

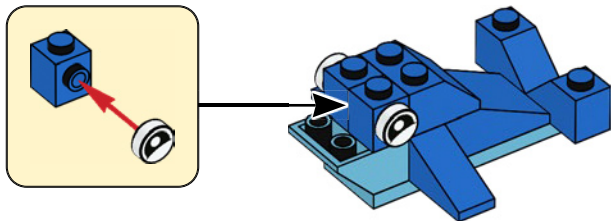

1x

9

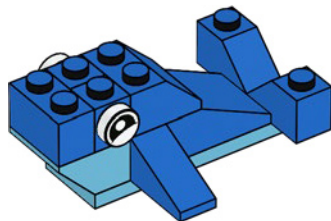

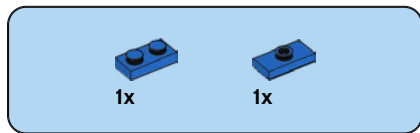

10

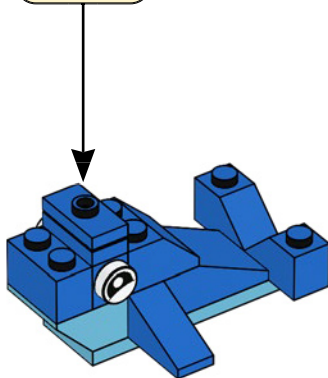
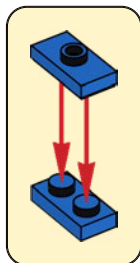



2x

11

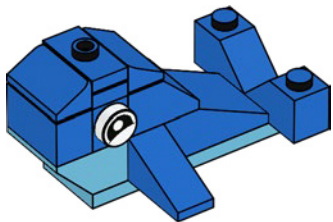

1x

12

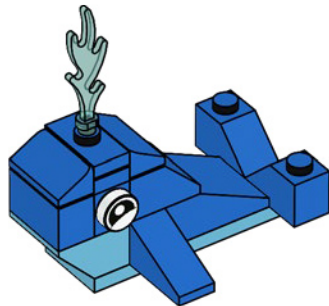

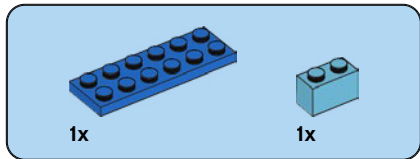
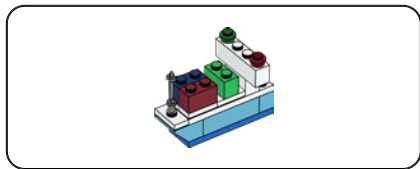

**1**

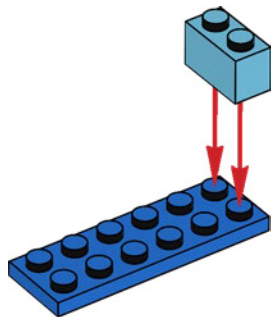

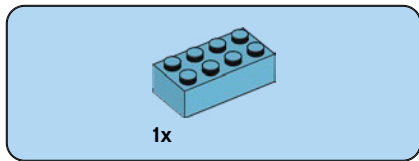

**2**

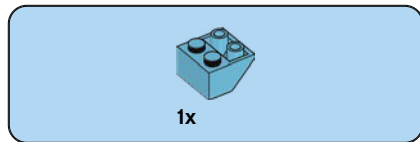
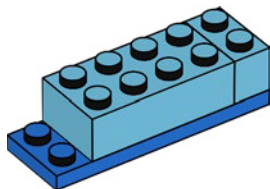

**3**

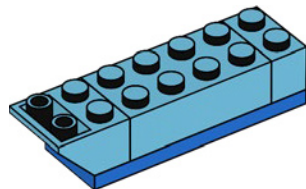



1x

4

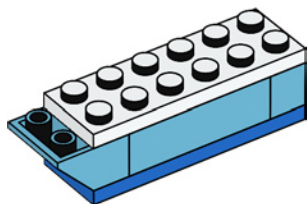

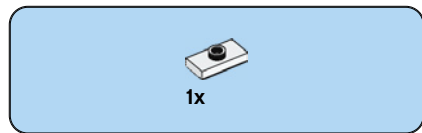

5

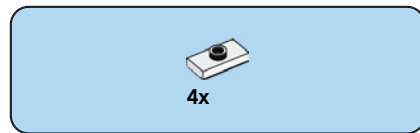
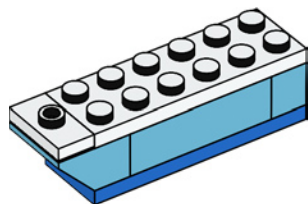

6

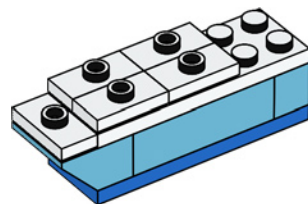



1x

7

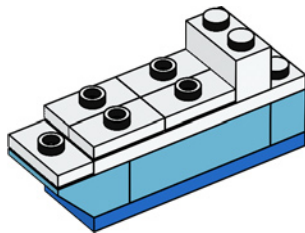



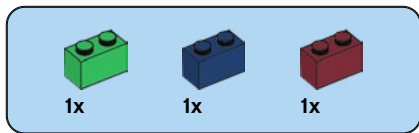

8

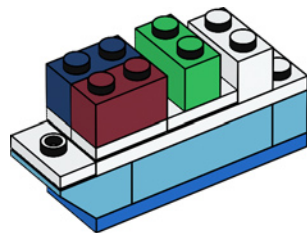

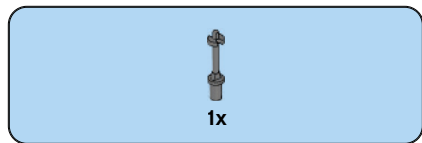

9

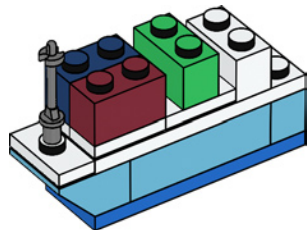

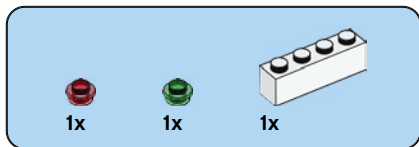

10

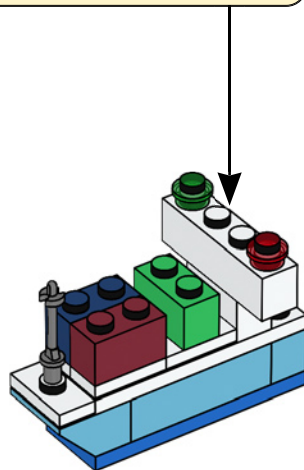
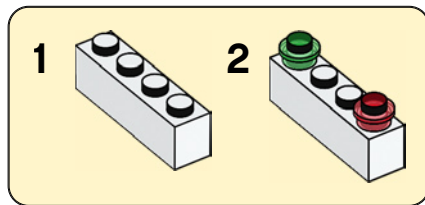

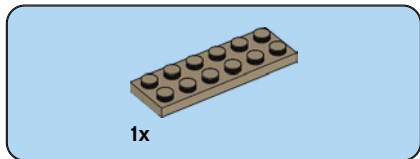
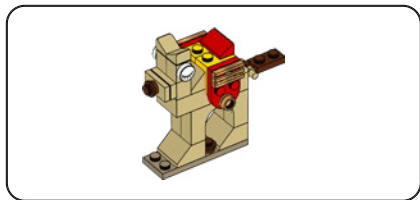

**1**

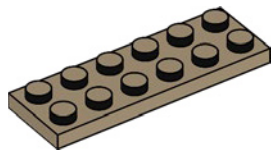

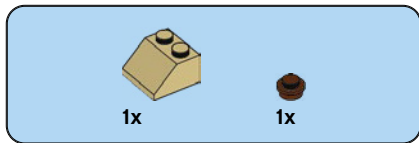

2

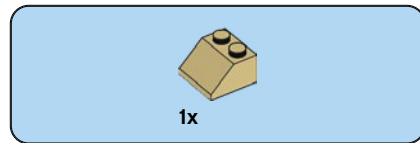
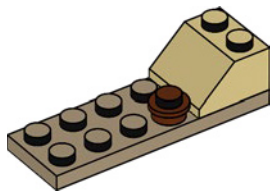

3

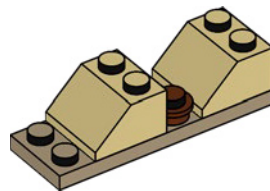

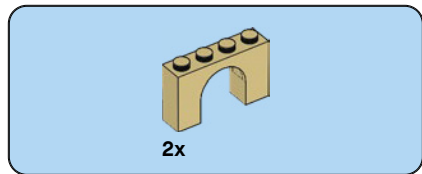

4

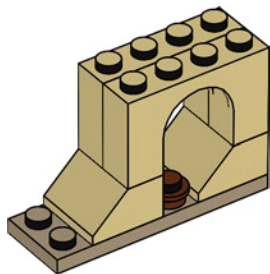



1x

5

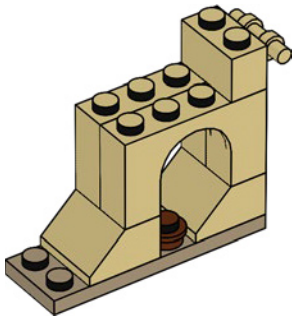

1x

6

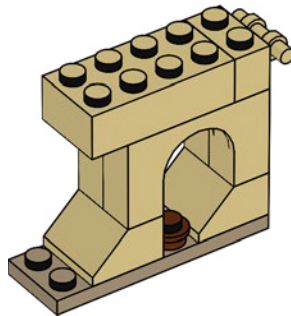



2x

7

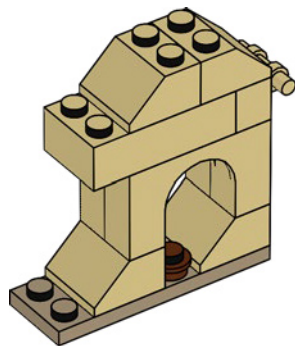





1x

8

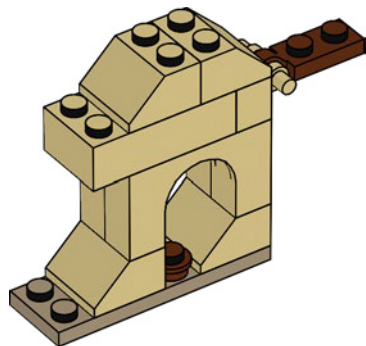

2x

9

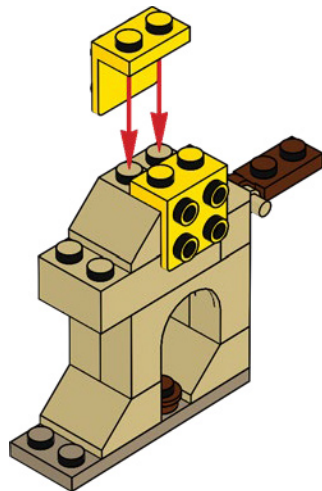

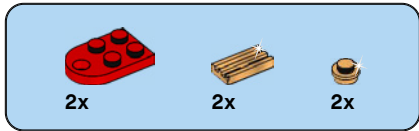

10

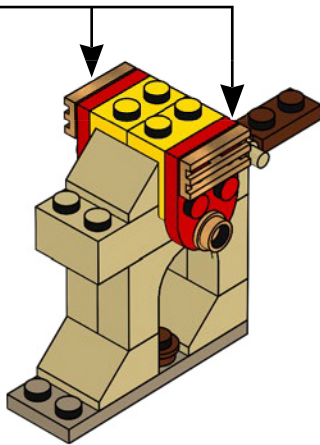
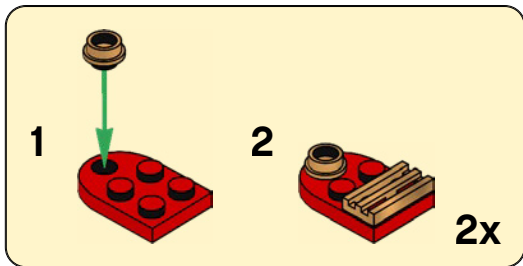



1x

11

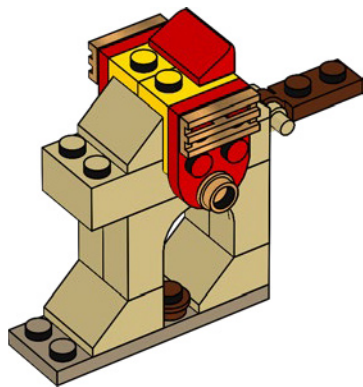

1x

12

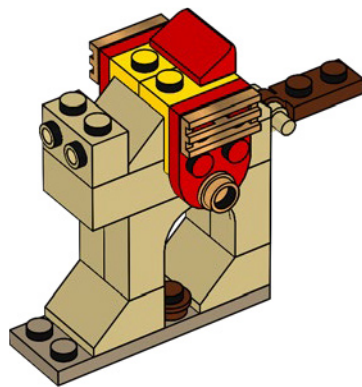



13

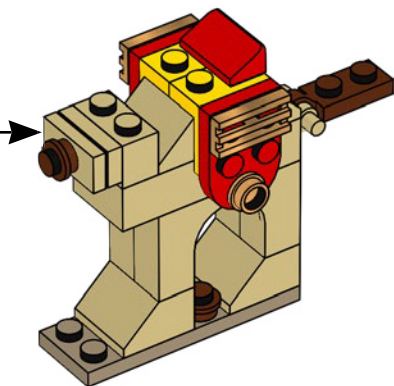
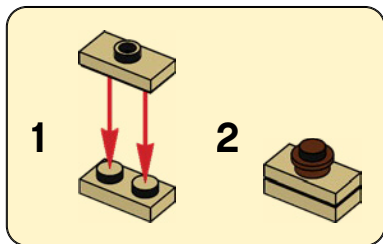



2x



2x

# 14

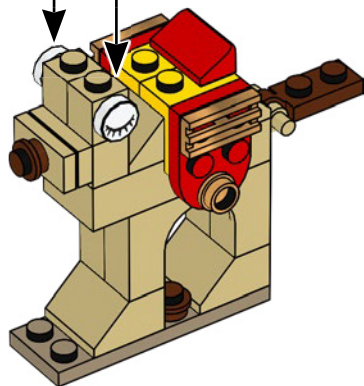
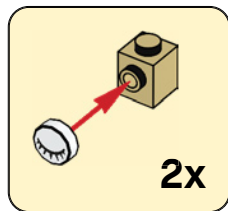

2x

# 15

