

1

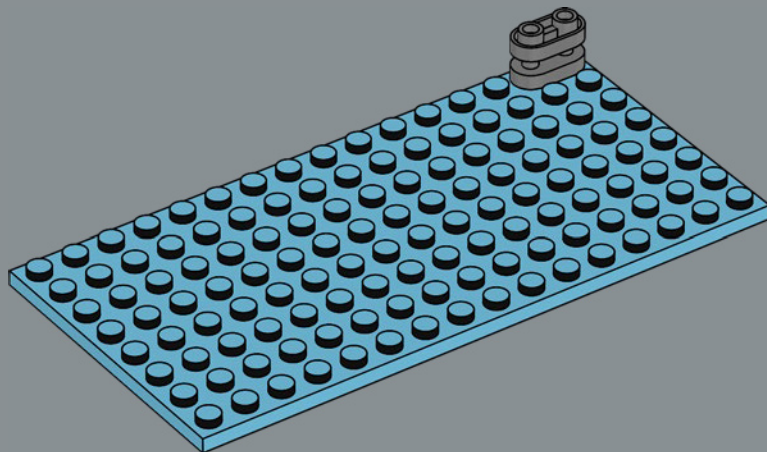

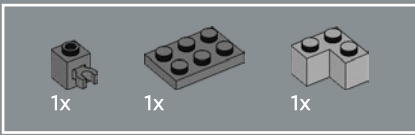



2

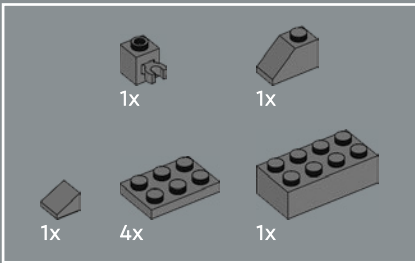
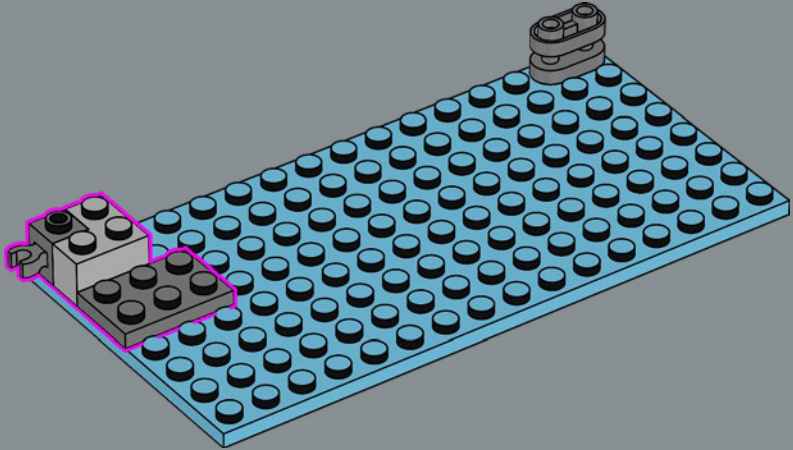

3

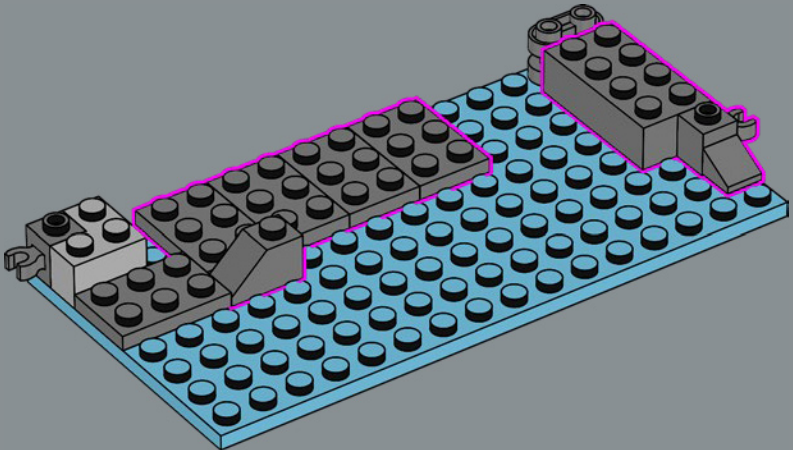

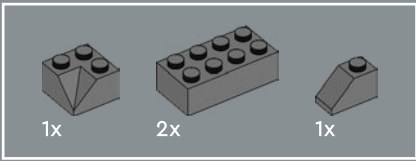

4

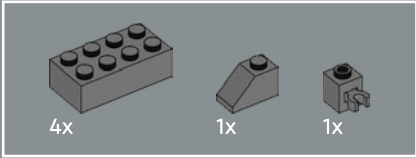
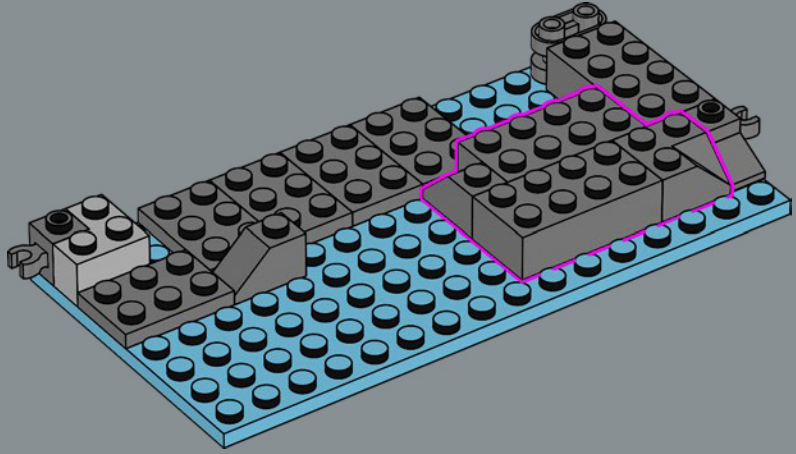

5

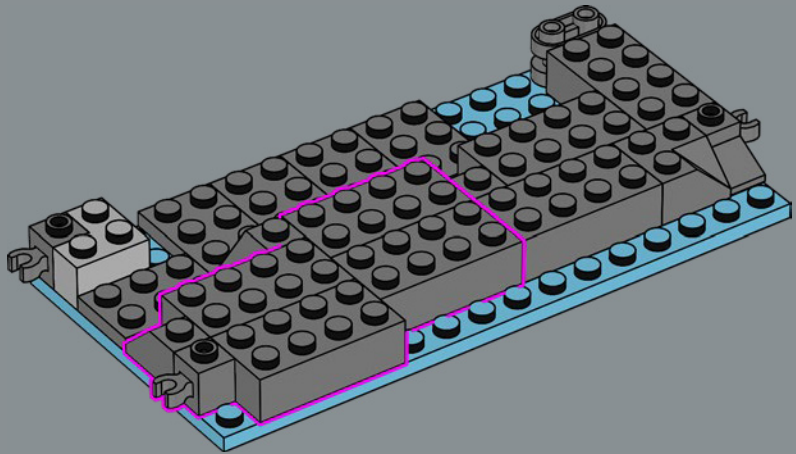

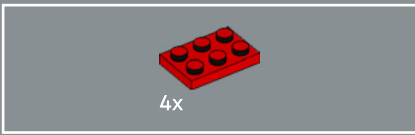

6

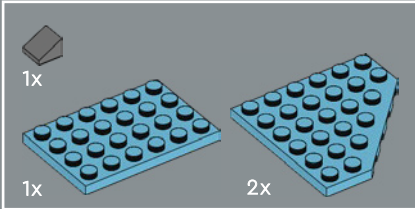
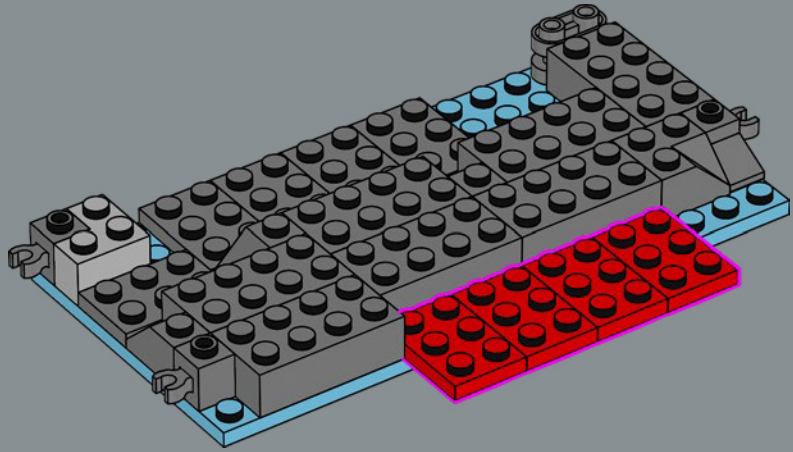

7

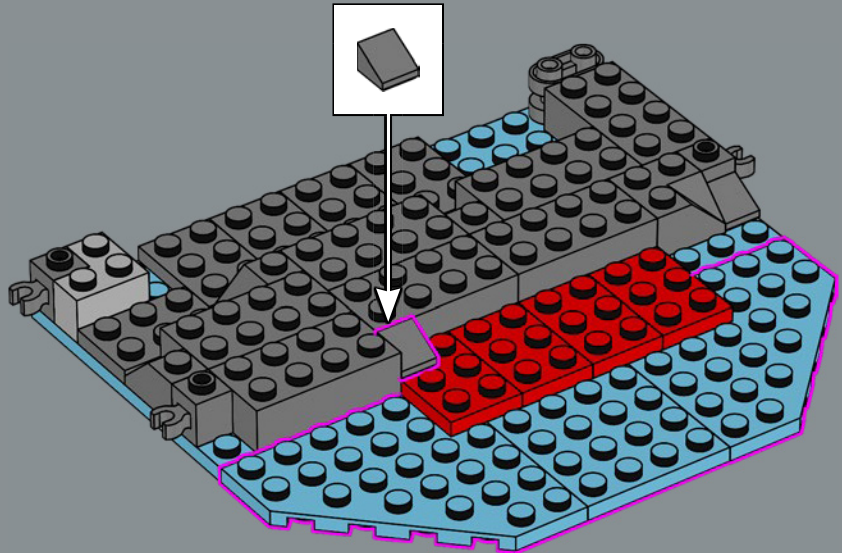

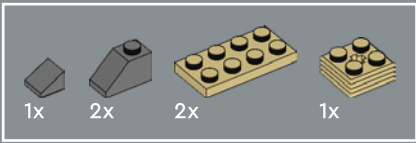

8

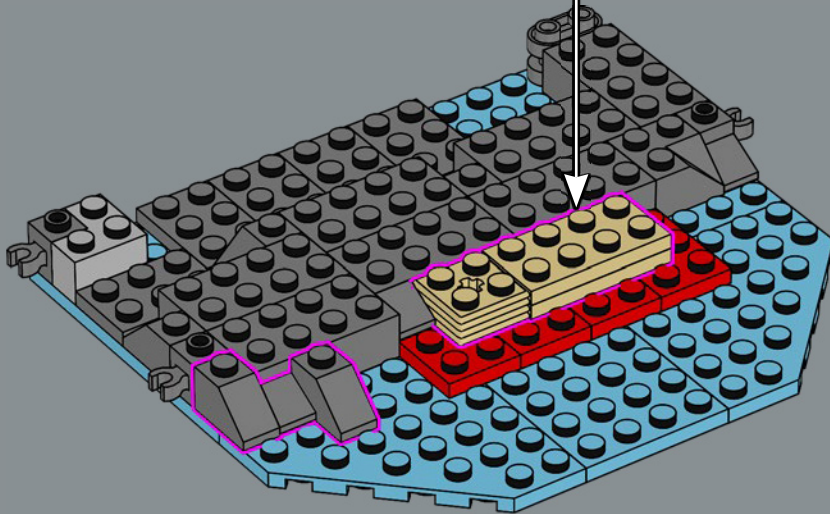
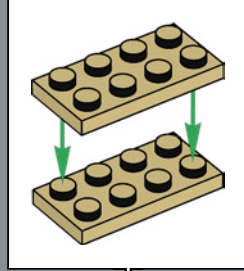



9

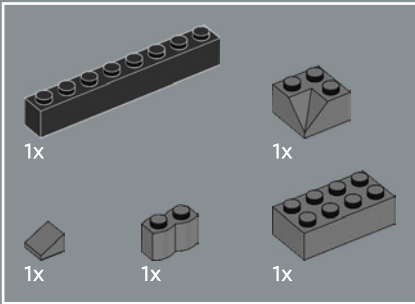
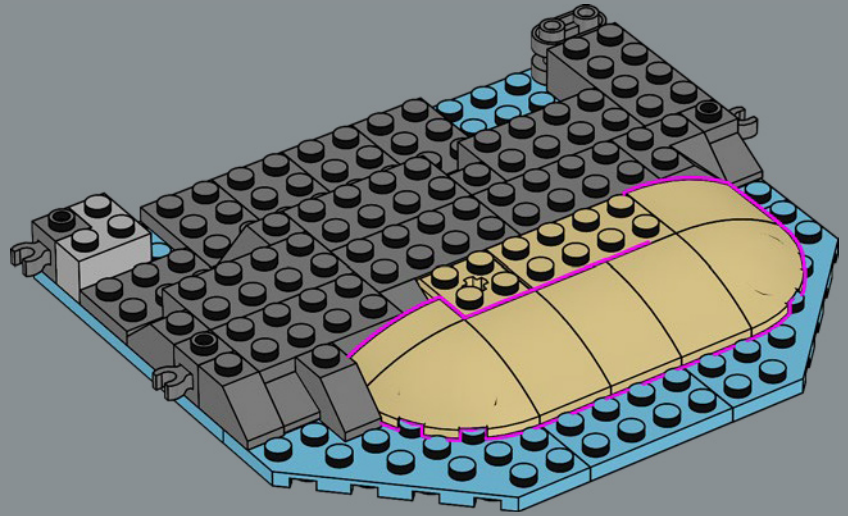

10

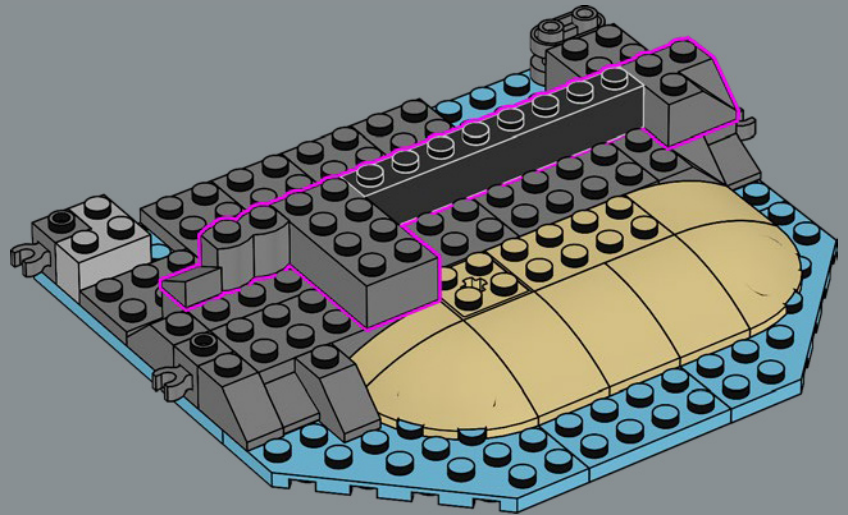



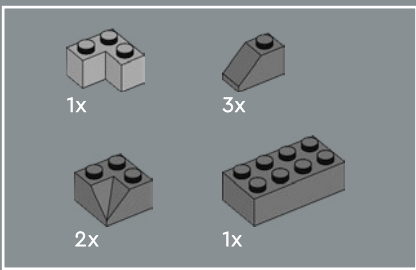

11

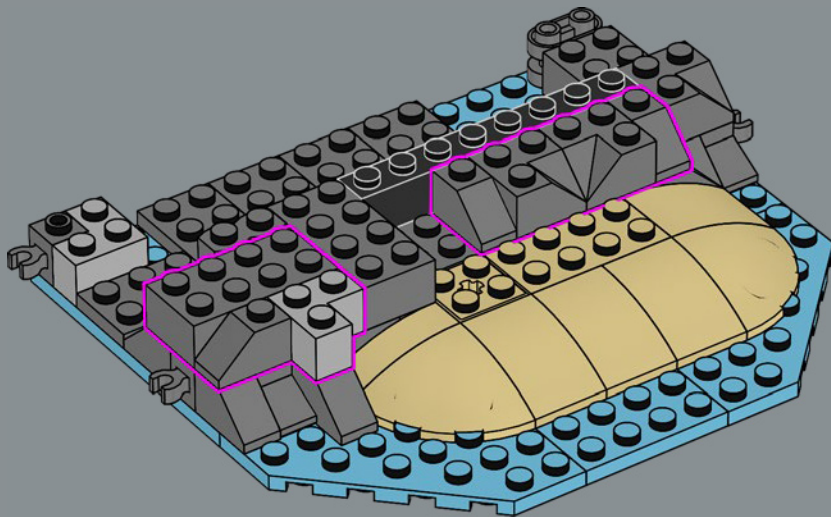

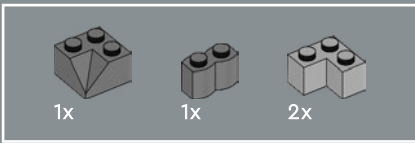

12

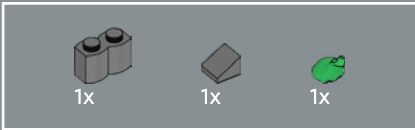
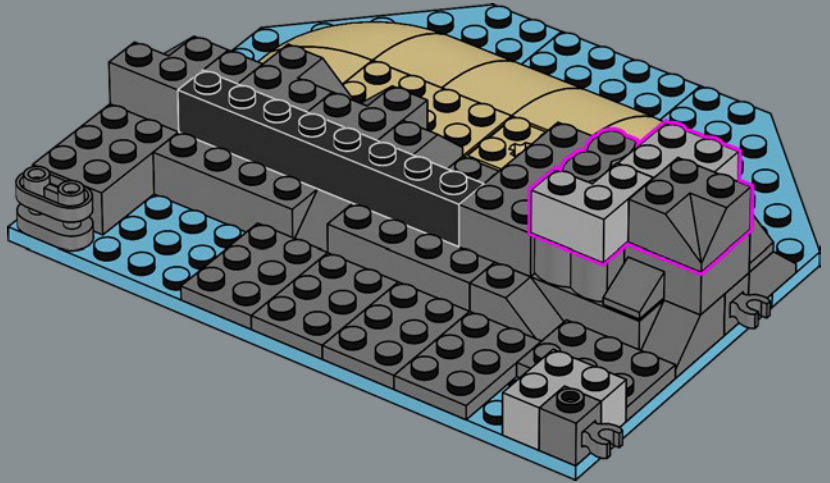

13

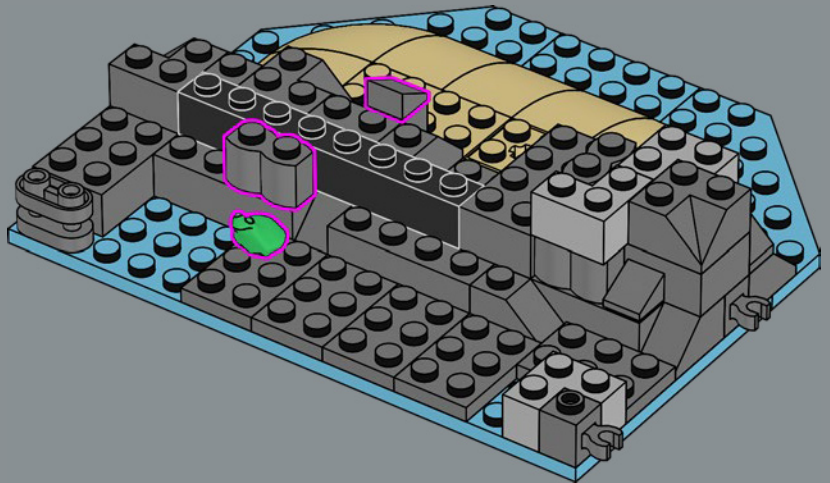

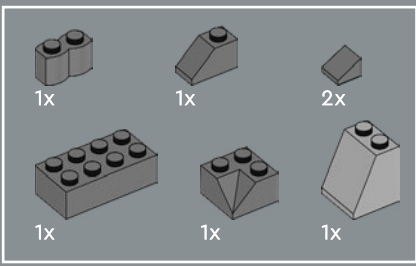

14

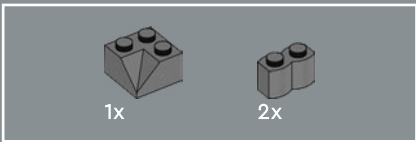
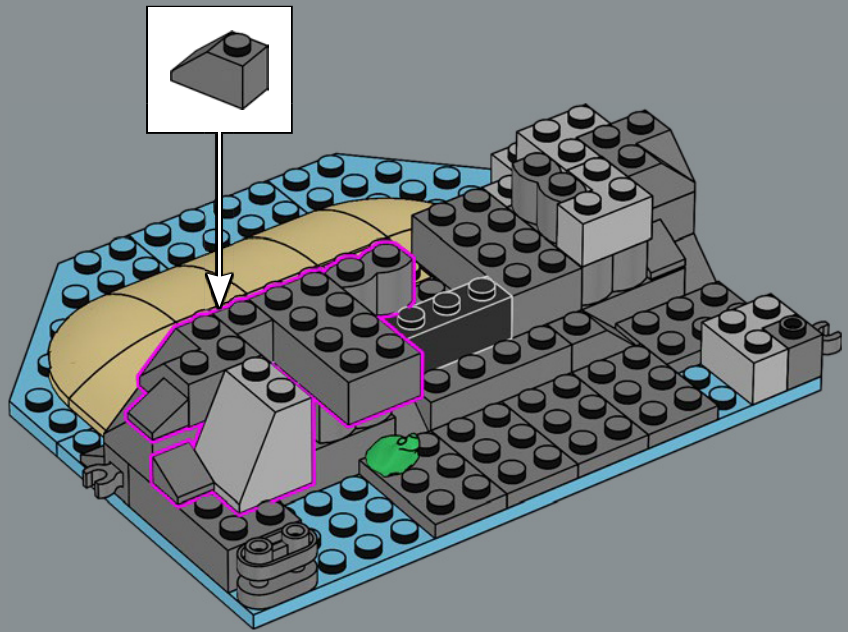

15

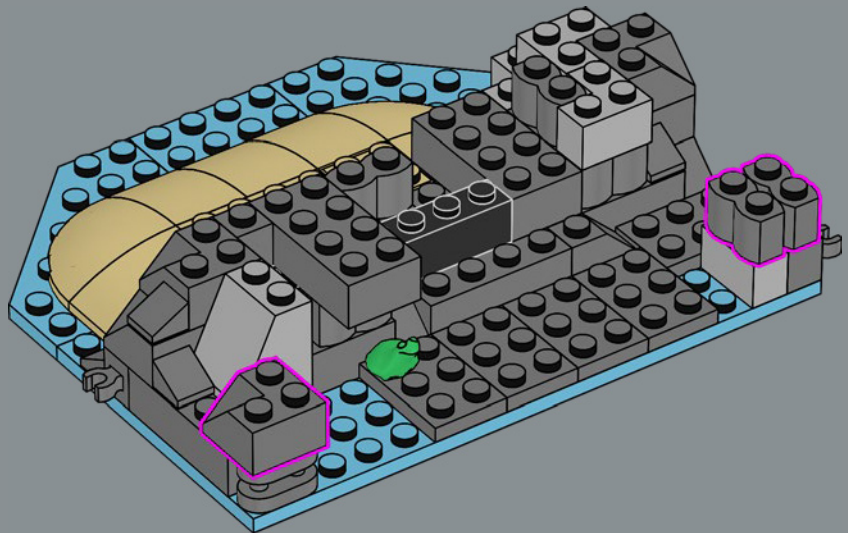

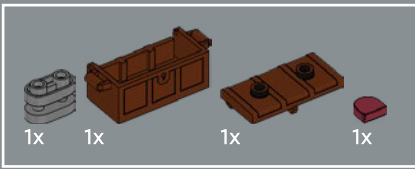

16

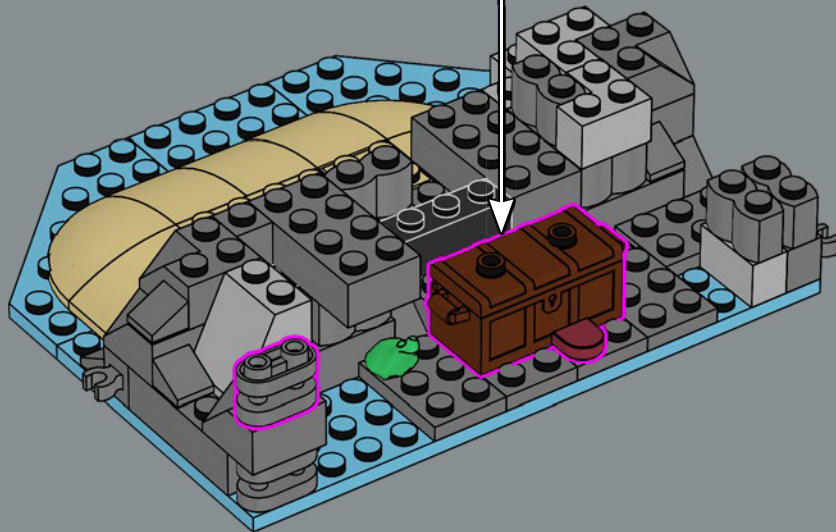
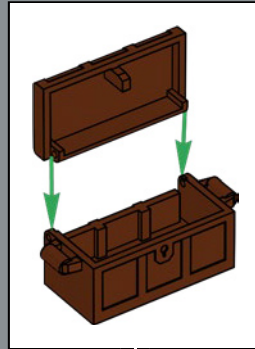

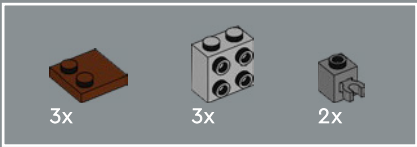

17

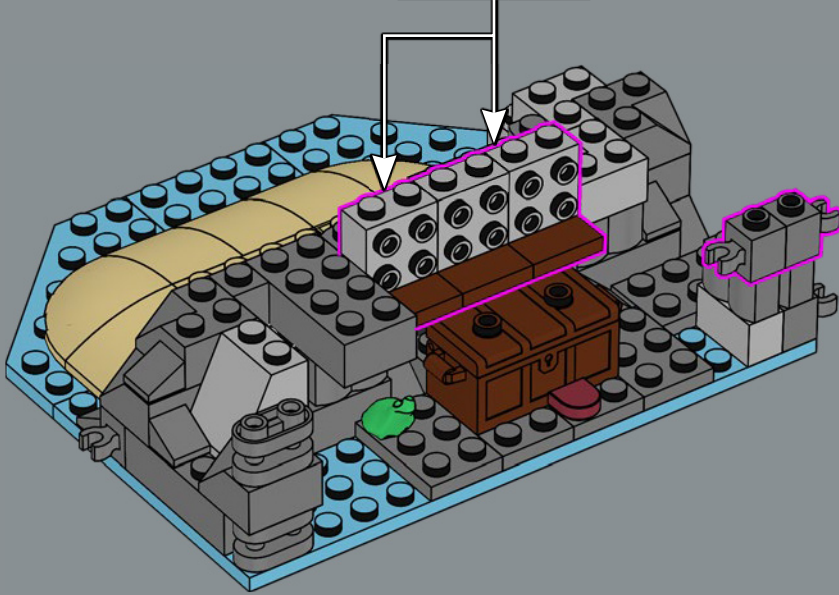
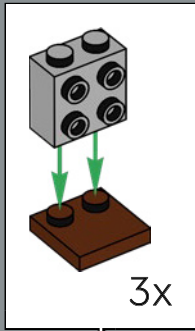





18

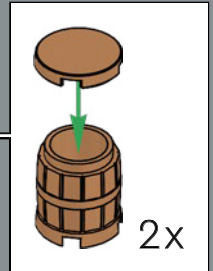
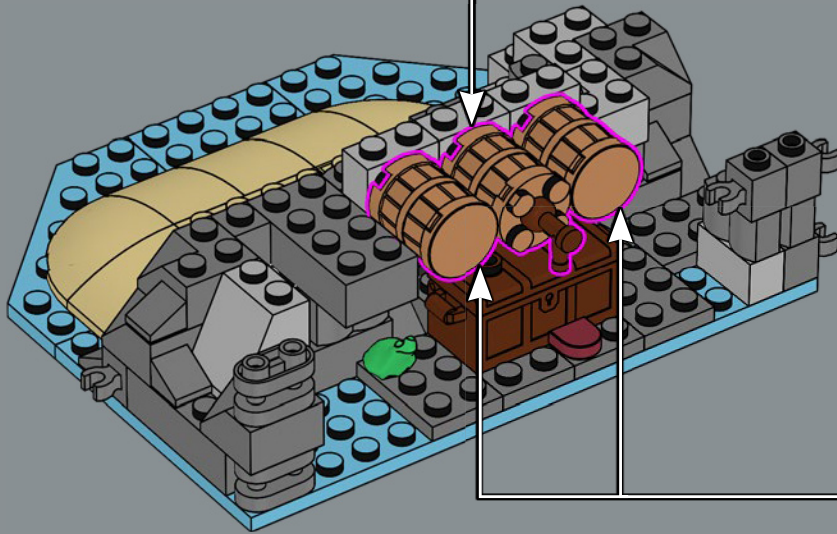
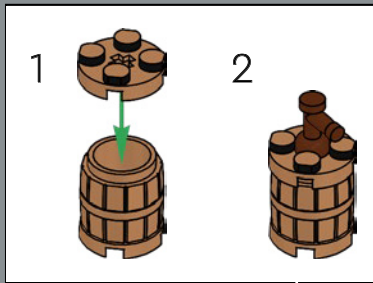

The cask is leaking. Perhaps those pirates should have practiced their shooting skills elsewhere...

Le tonneau a une fuite. Peut-être que ces pirates auraient dû pratiquer leurs compétences de tir ailleurs...

El barril tiene una fuga. Tal vez esos piratas deberían probar su puntería en otra parte...

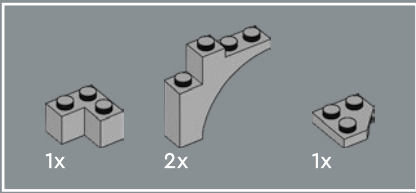

17

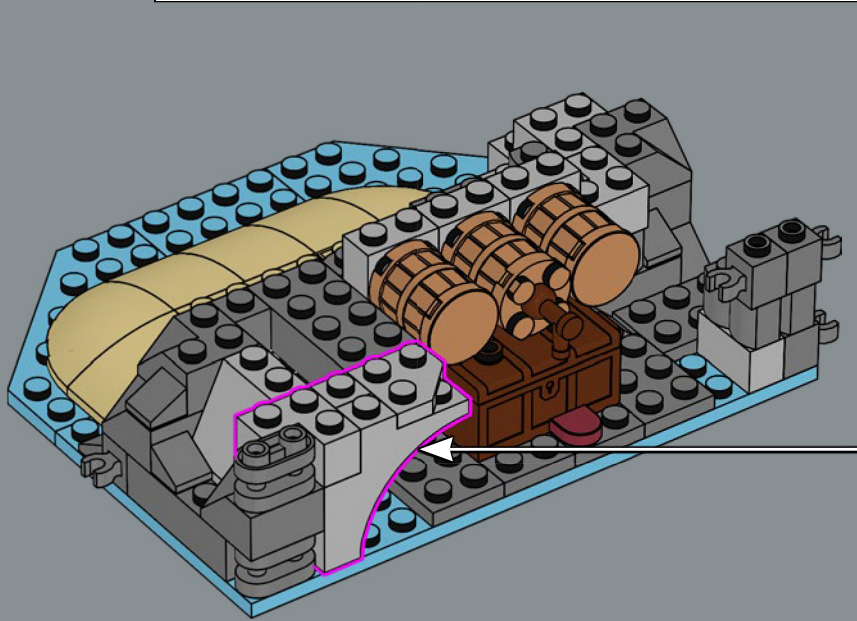
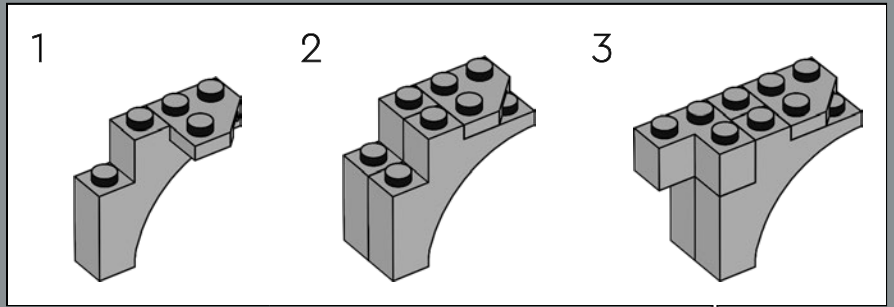

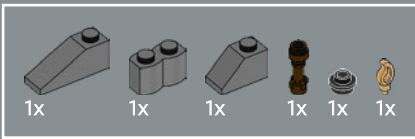

20

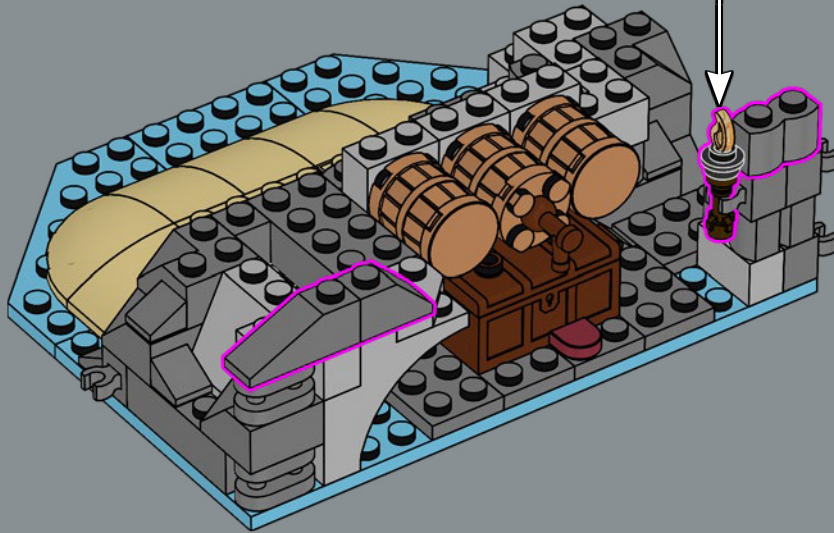
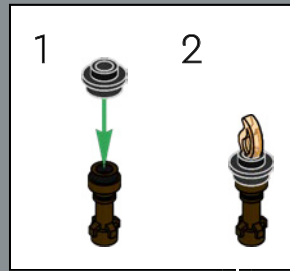

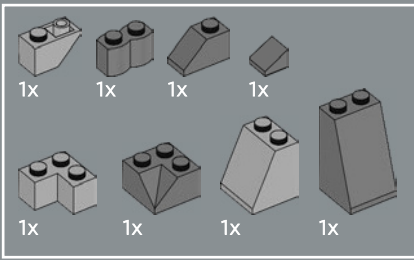

21

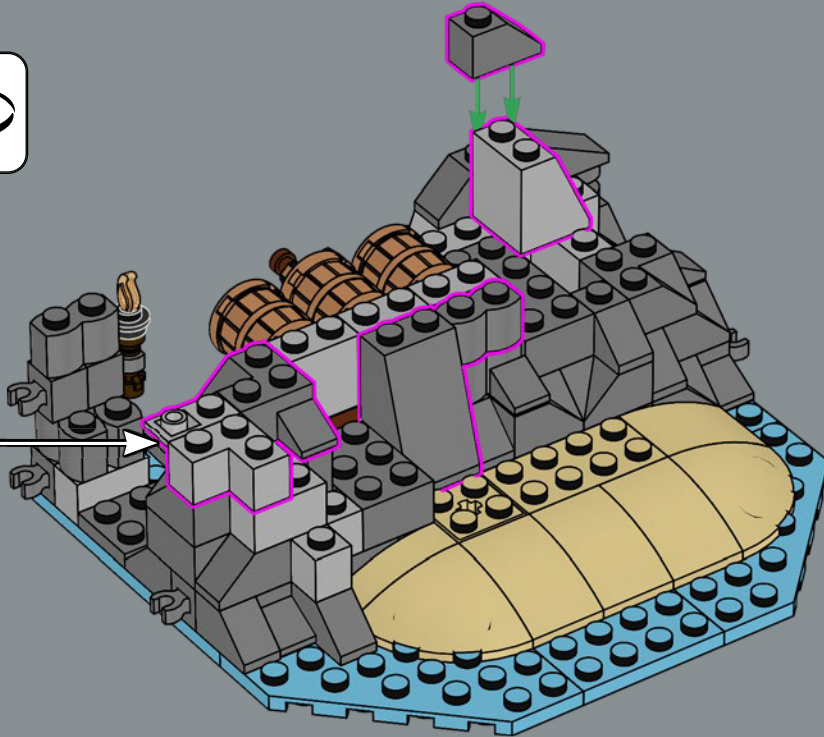
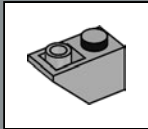

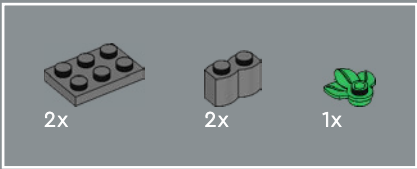

22

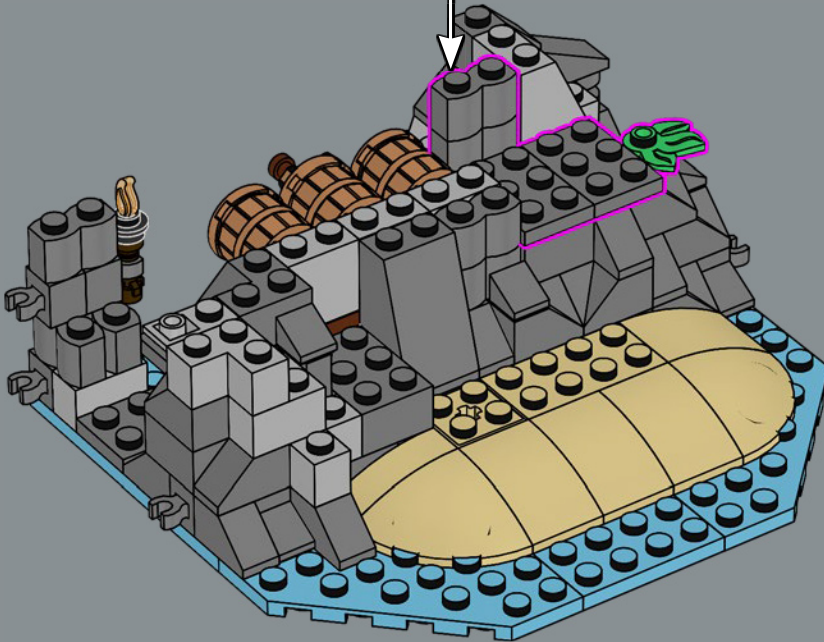
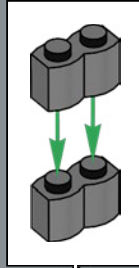



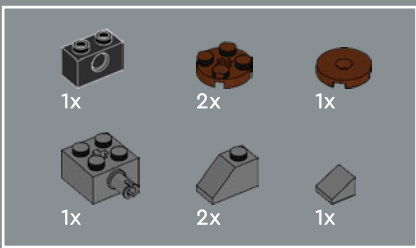

23

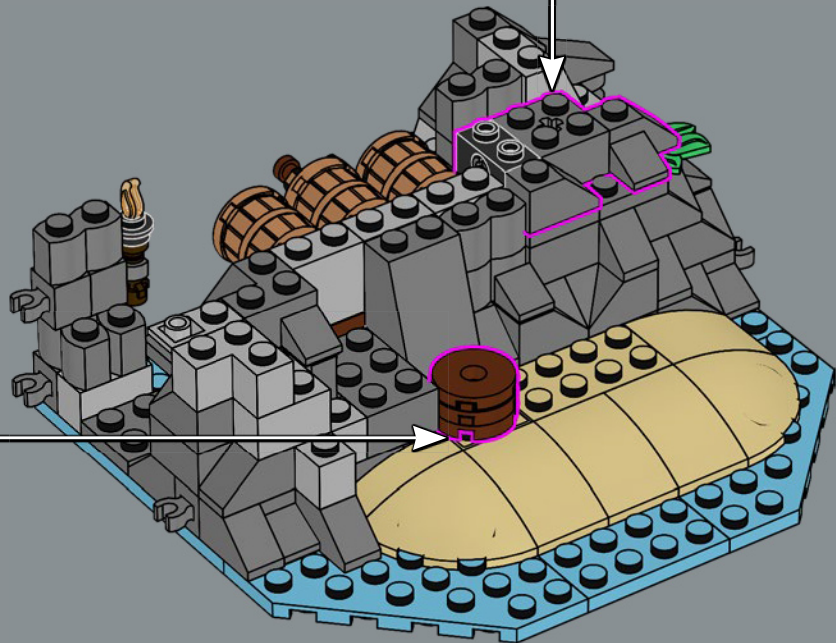
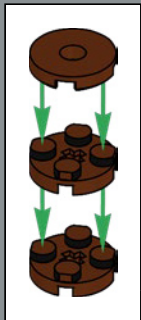
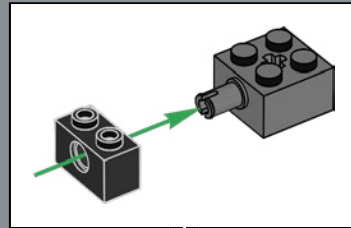

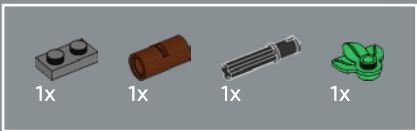

24

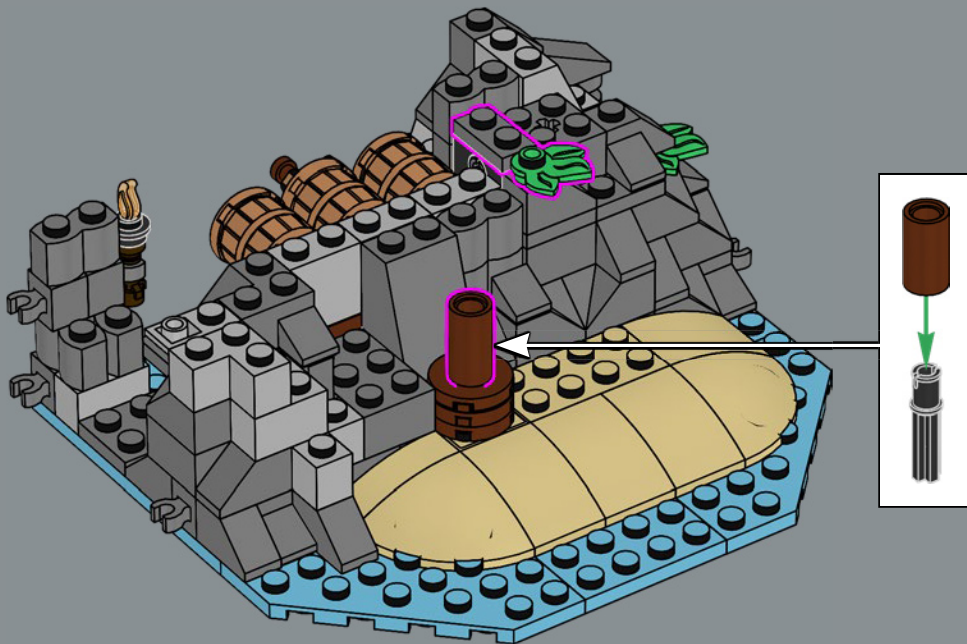

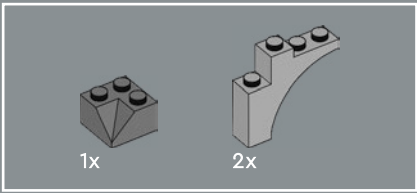

25

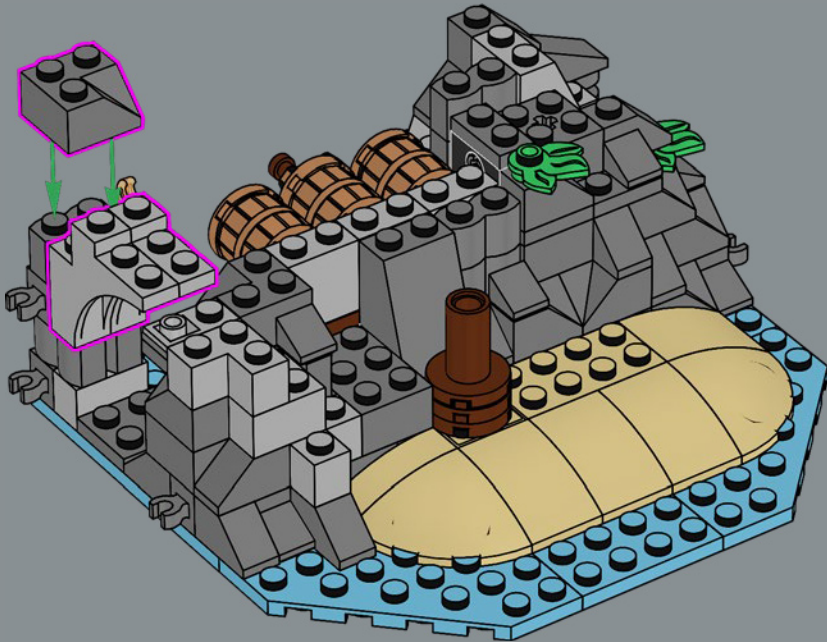

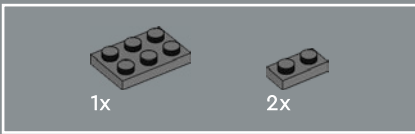

26

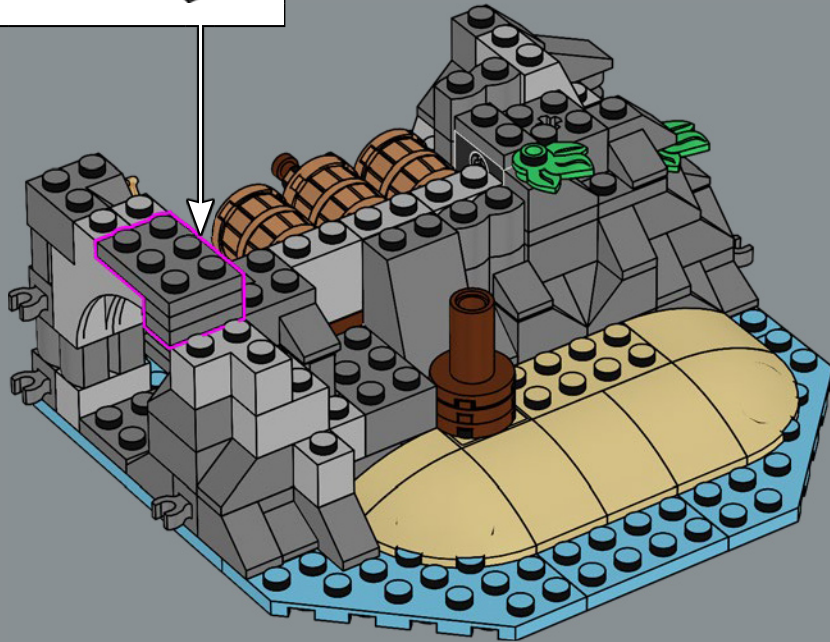
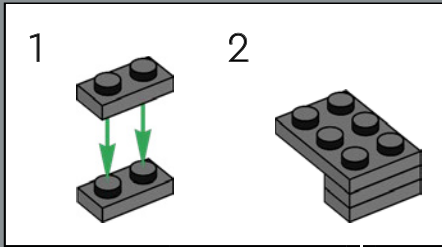

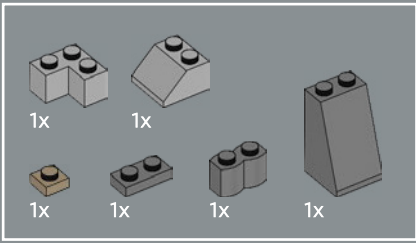

27

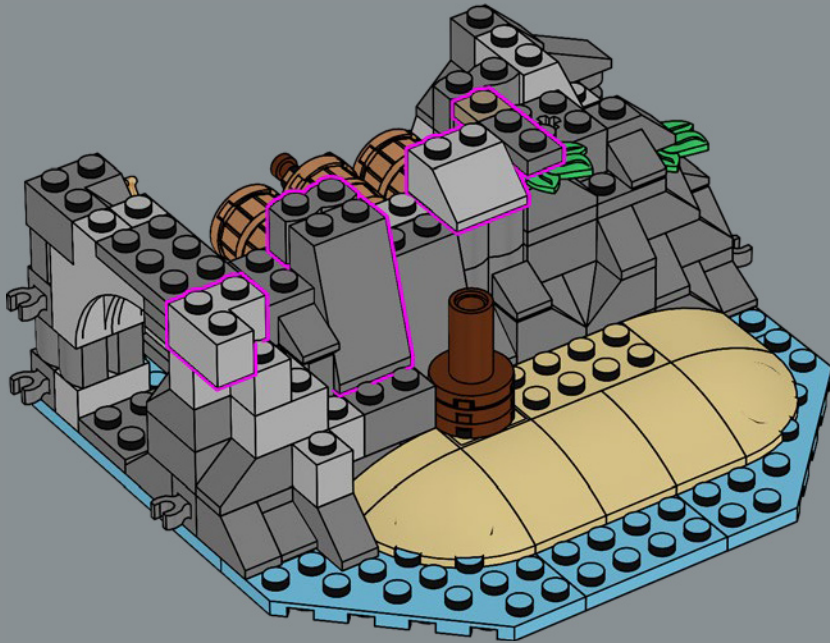



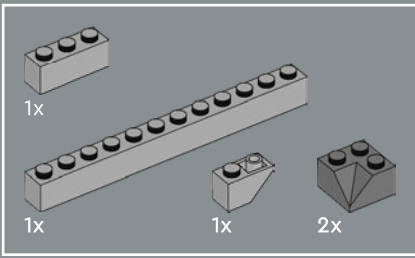

28

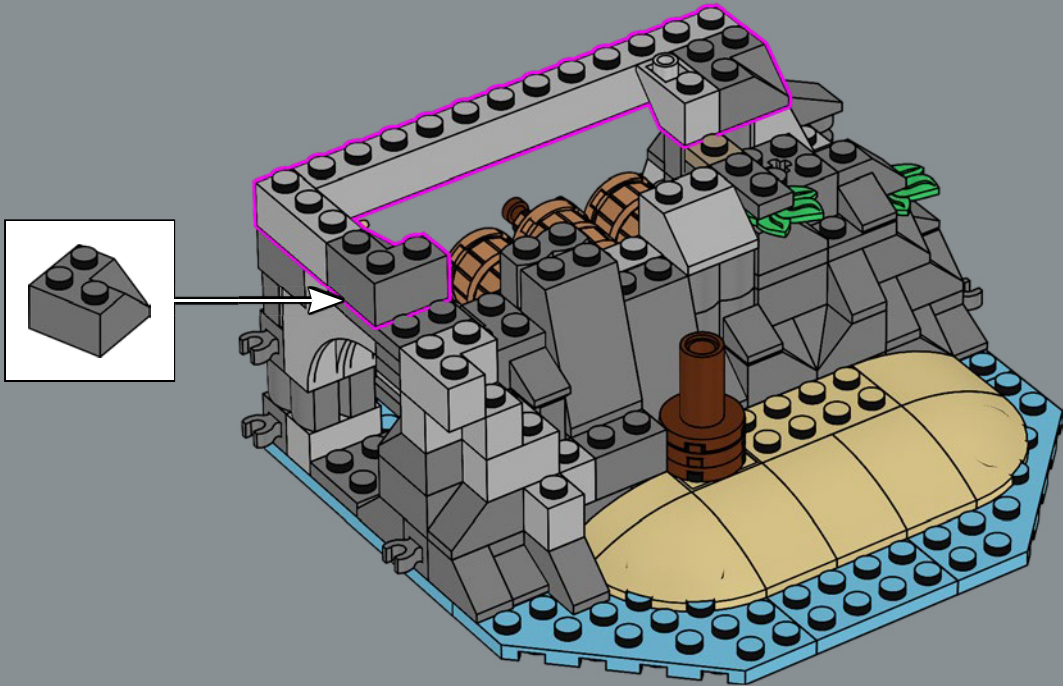

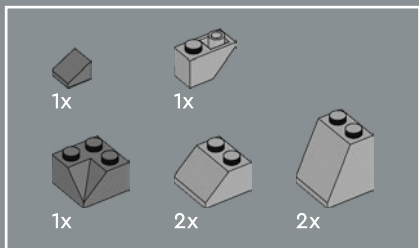

29

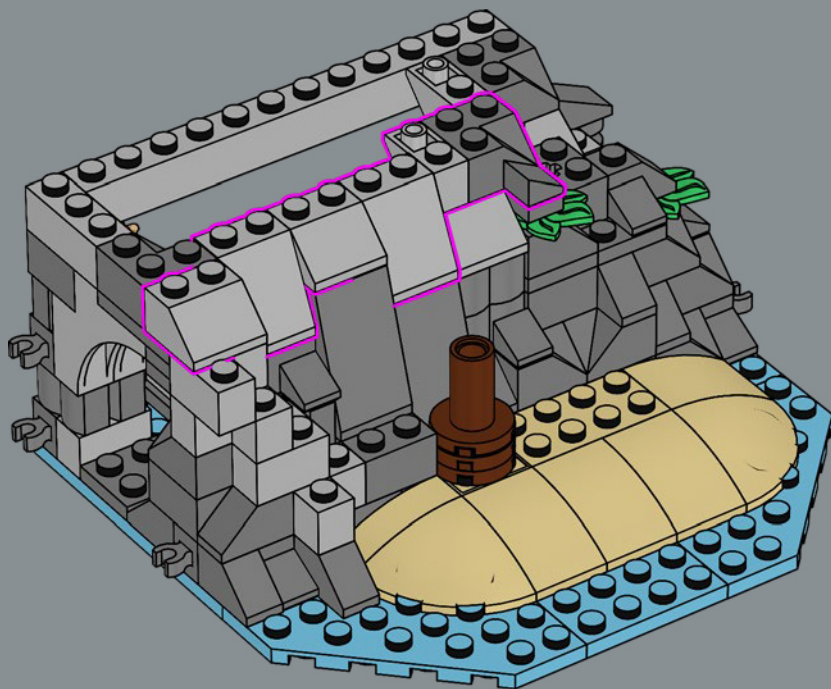

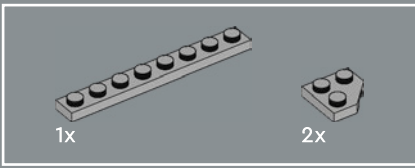

30

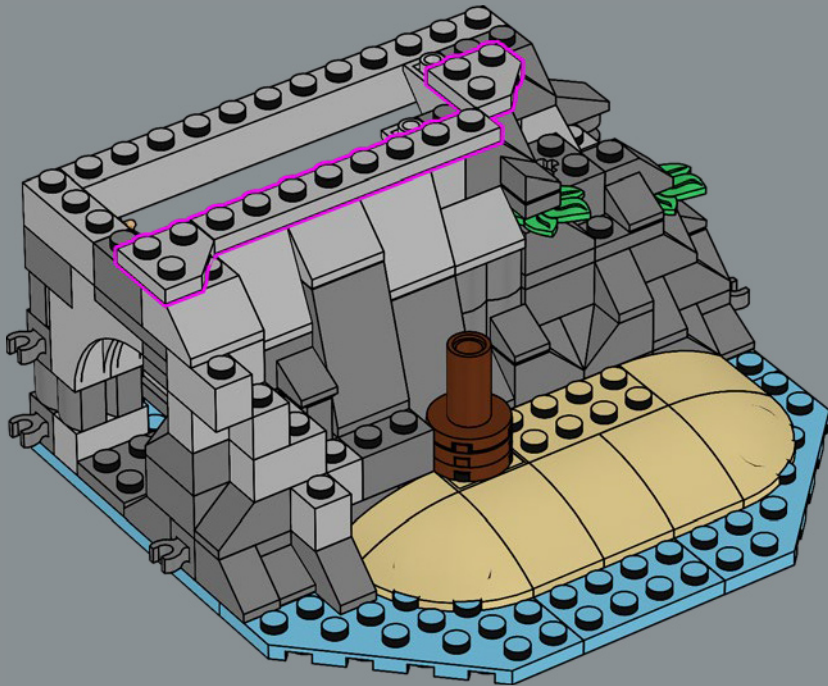

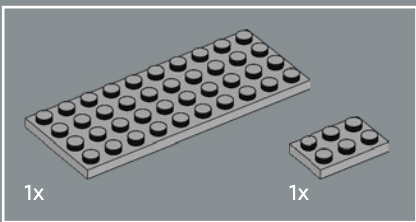

31

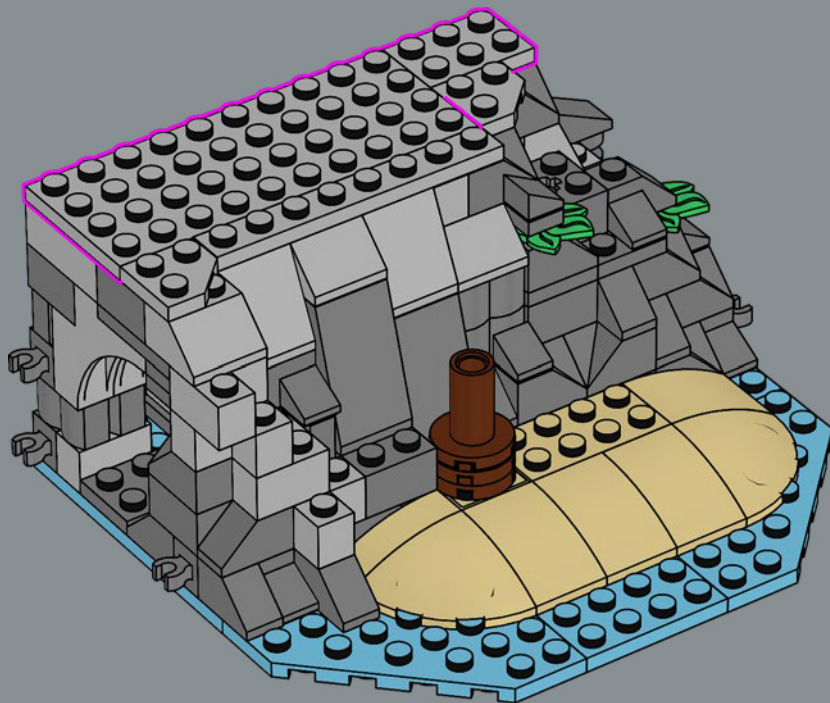

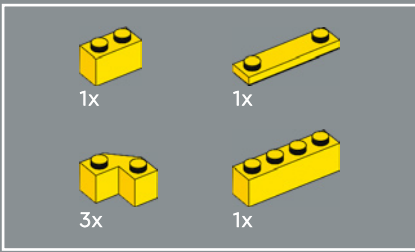

32

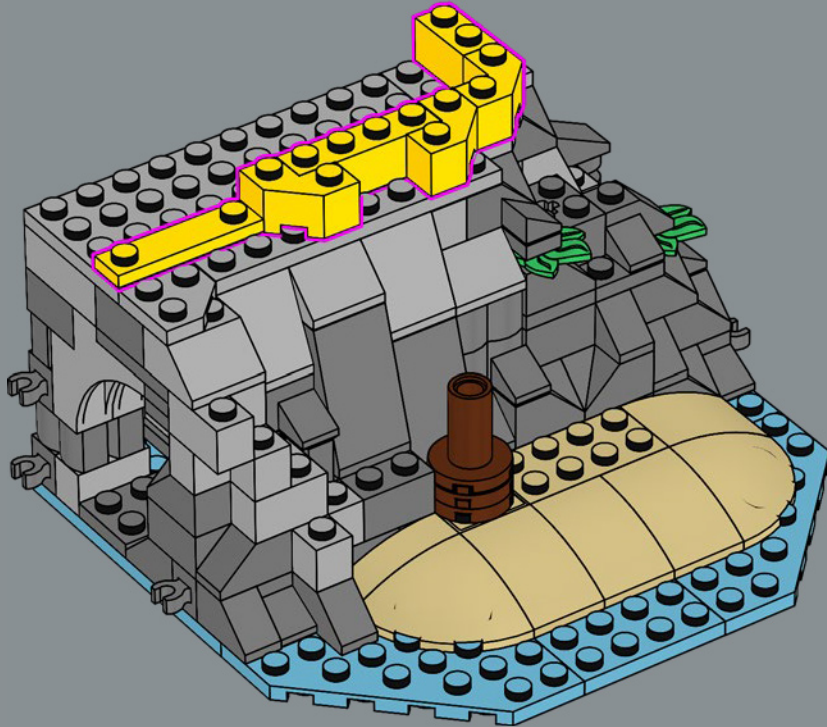



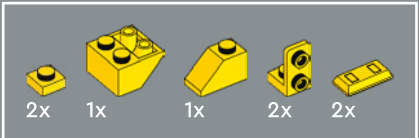

33

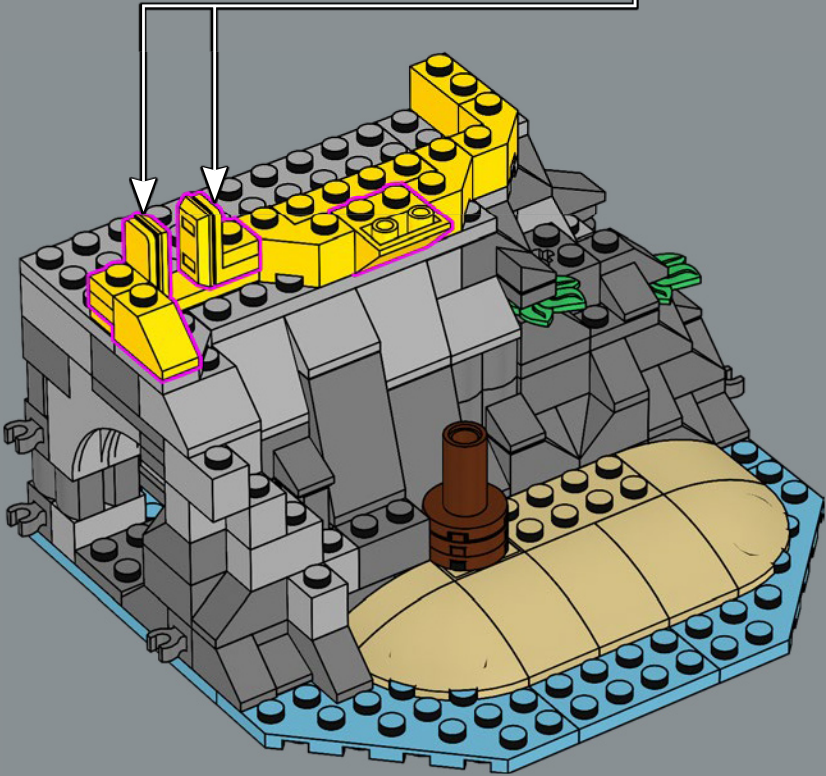
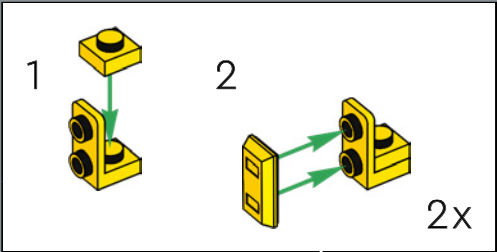

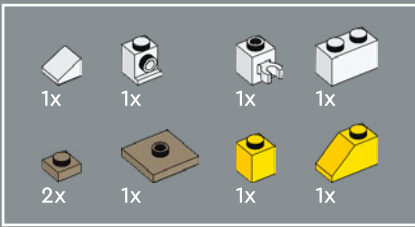

34

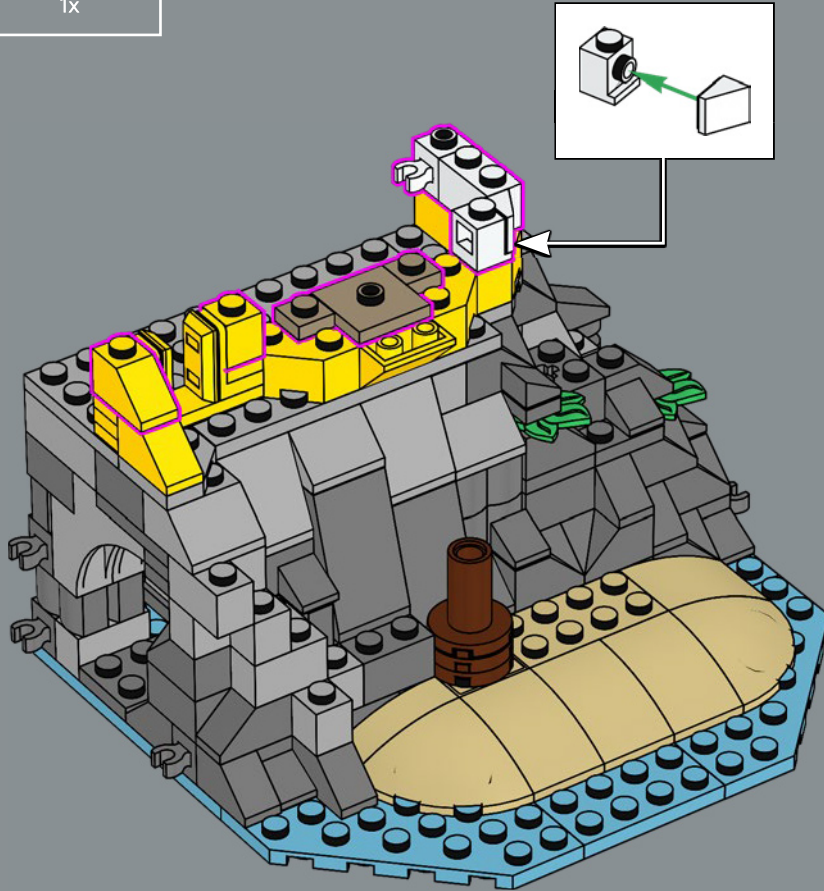

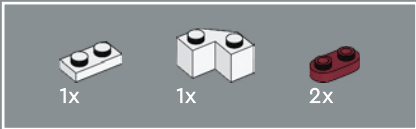

35

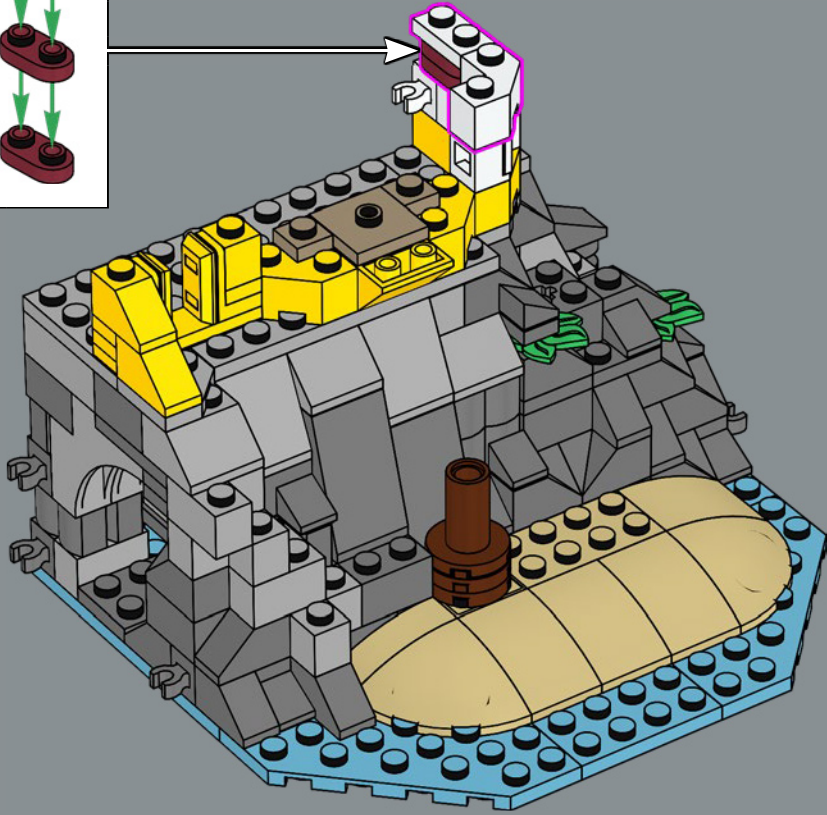
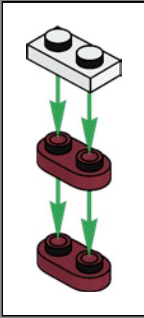

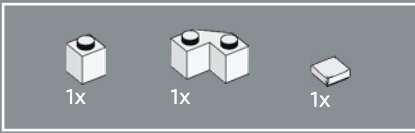

36

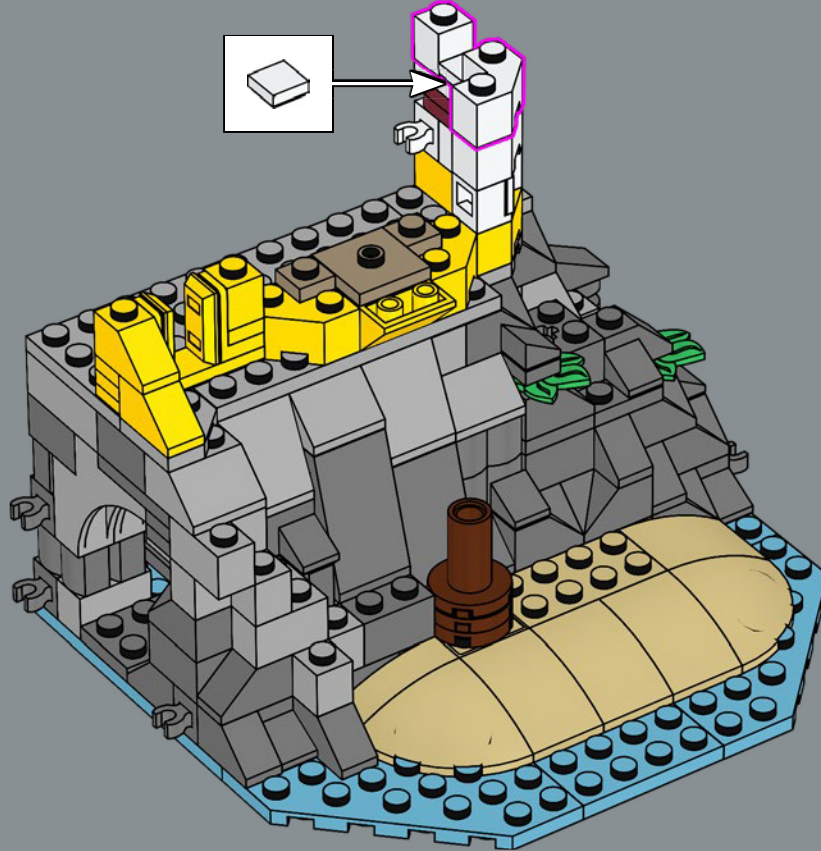

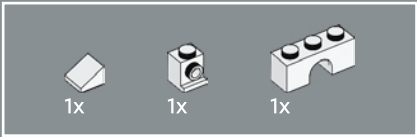

37

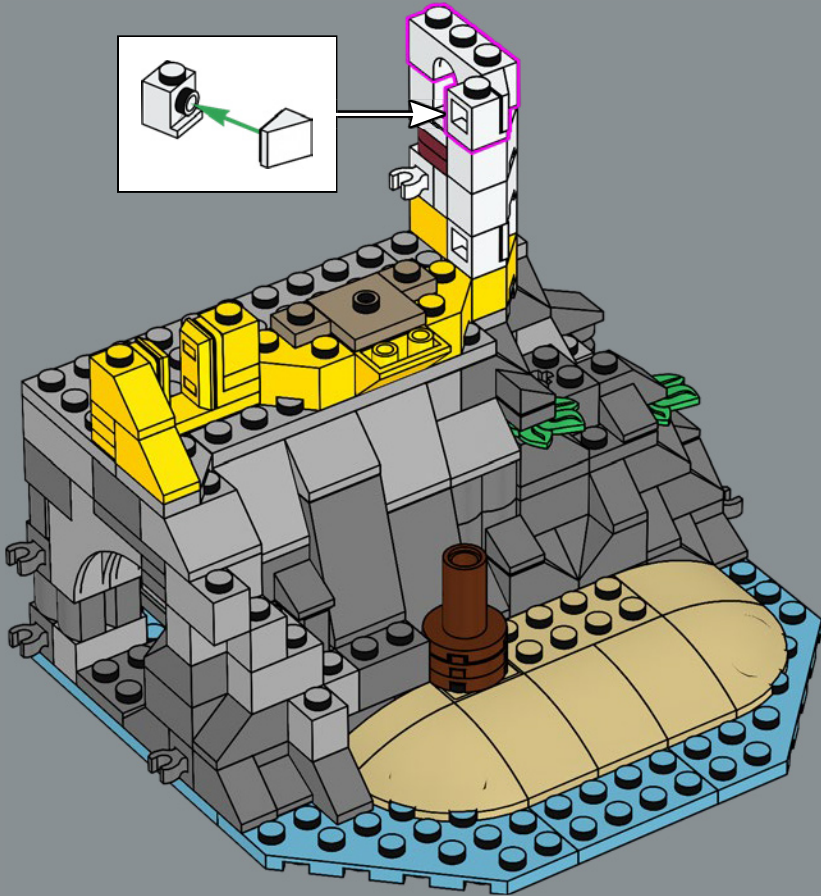



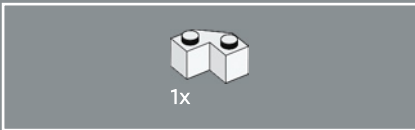

38

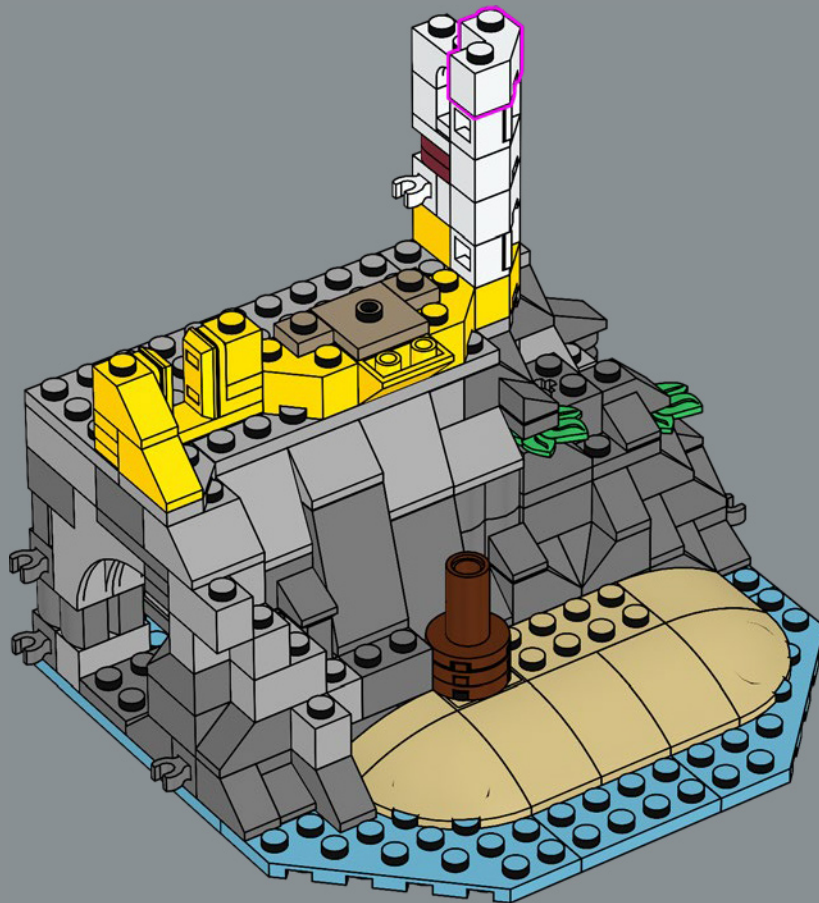

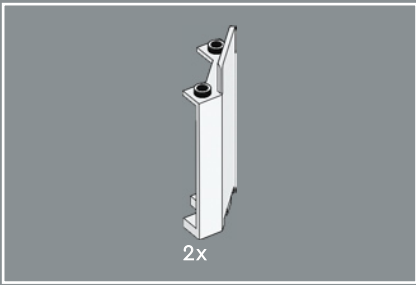

39

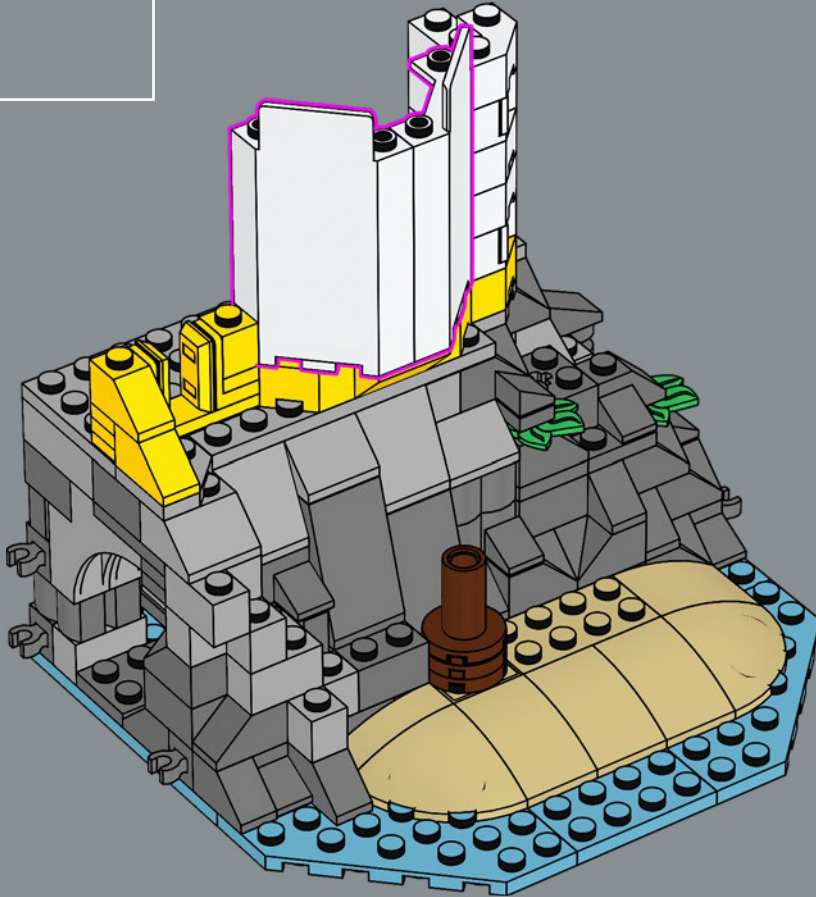



40

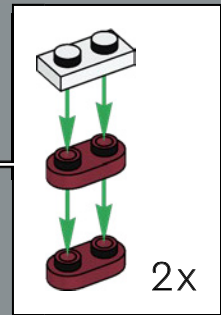
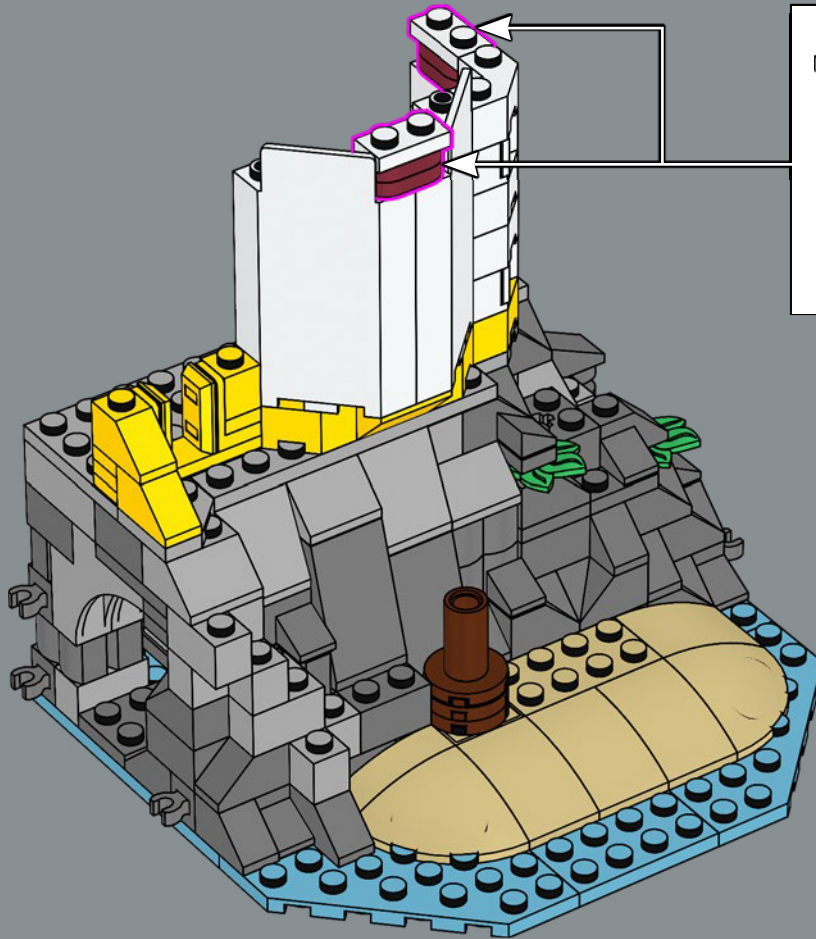

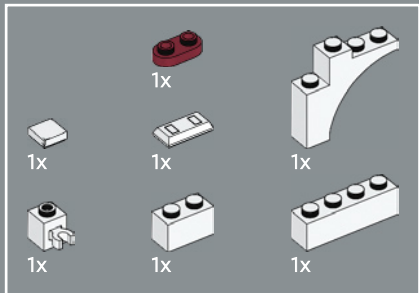

41

1

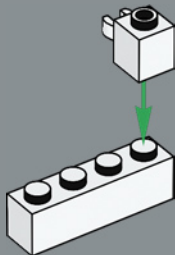

2

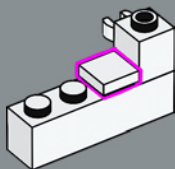

3

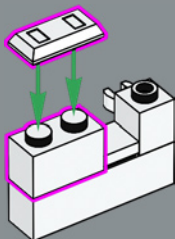

4

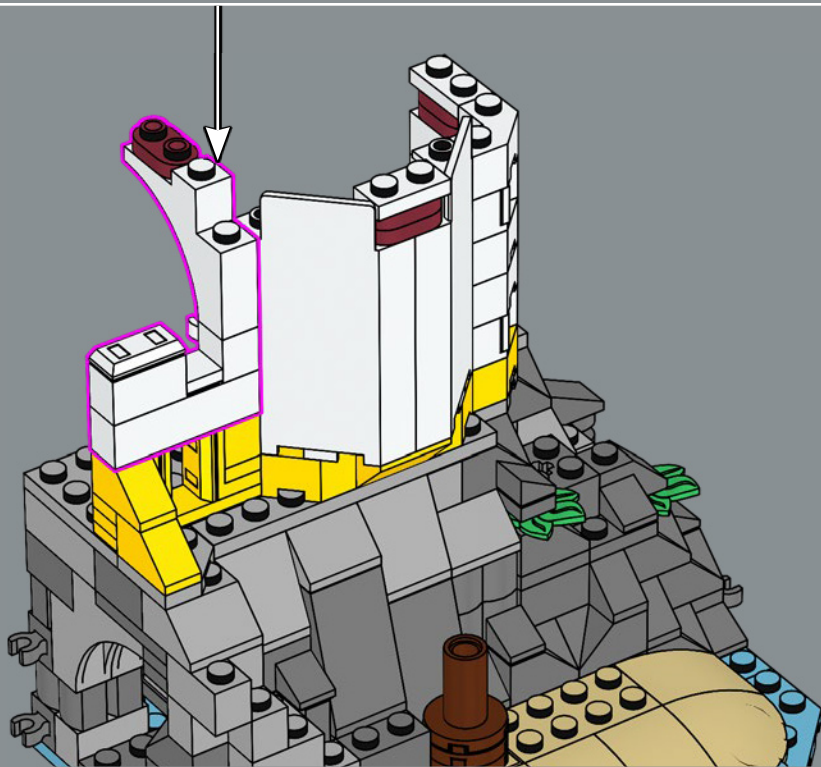
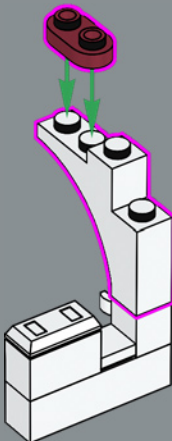

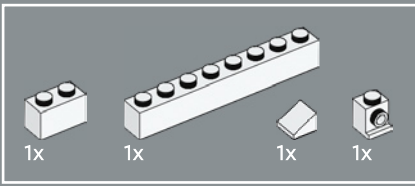

42

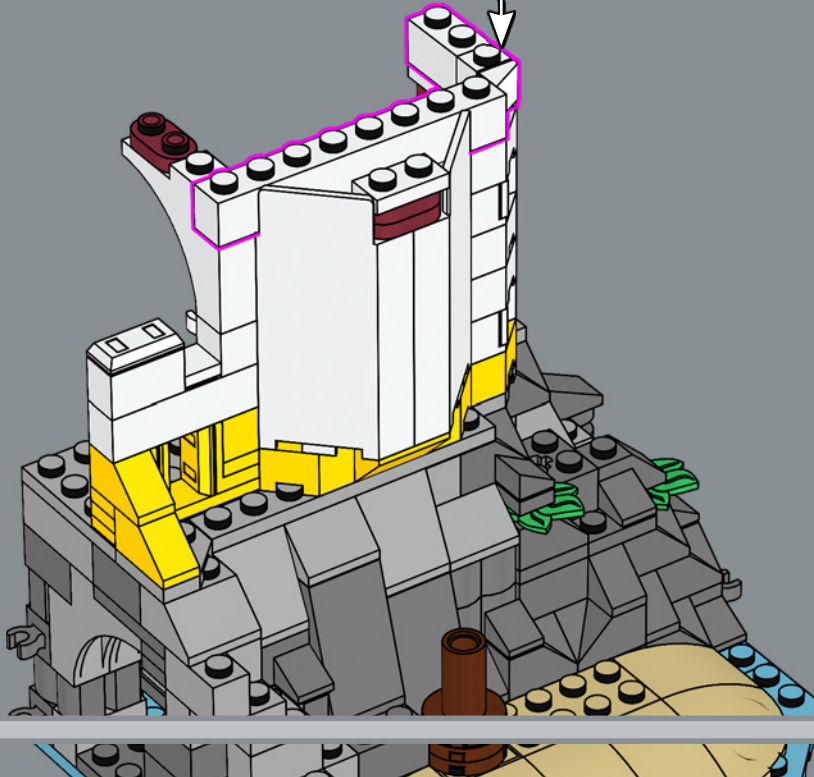
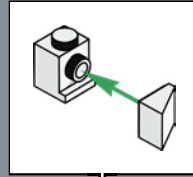



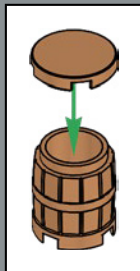
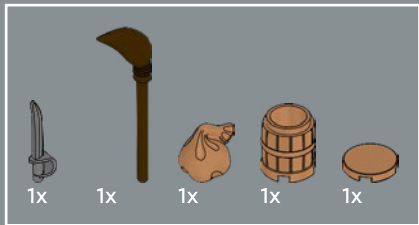

43

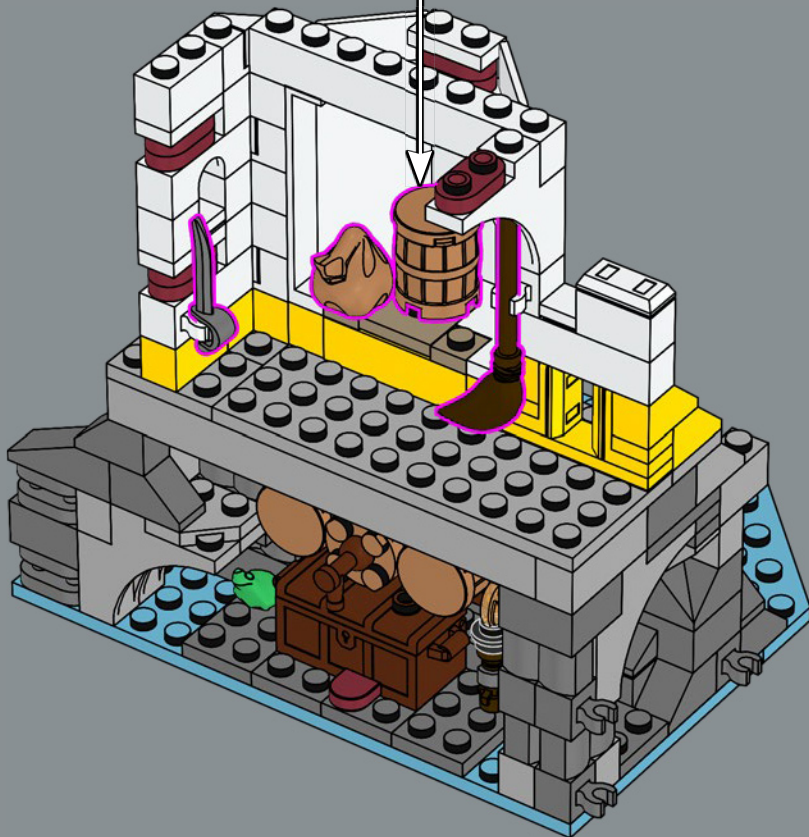

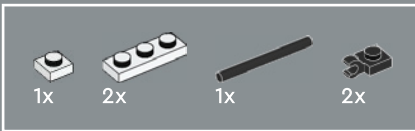

44

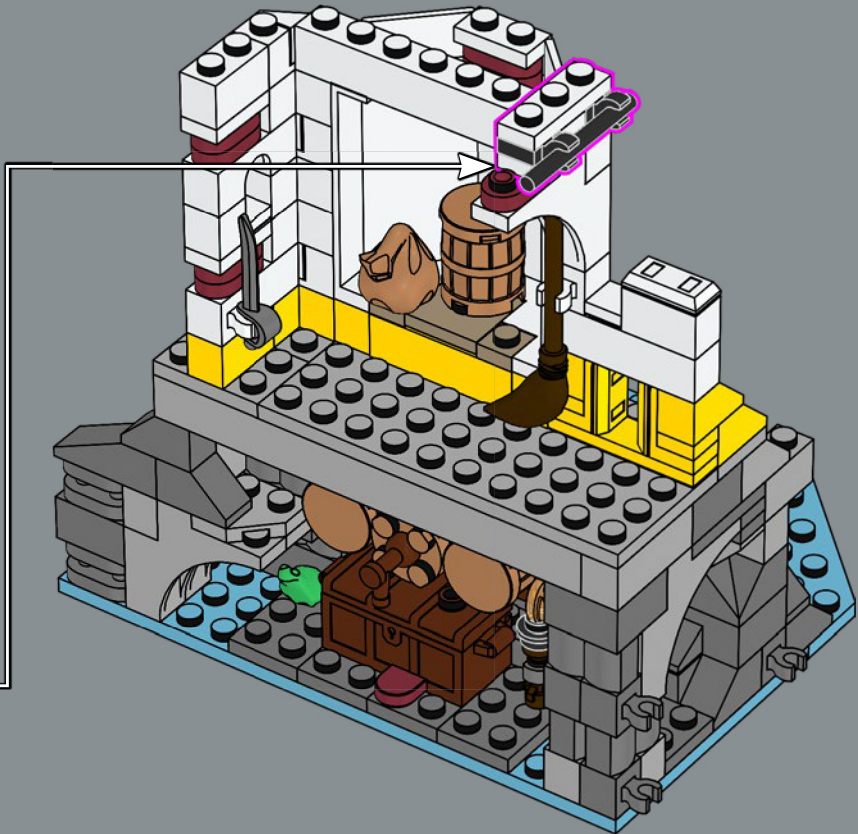
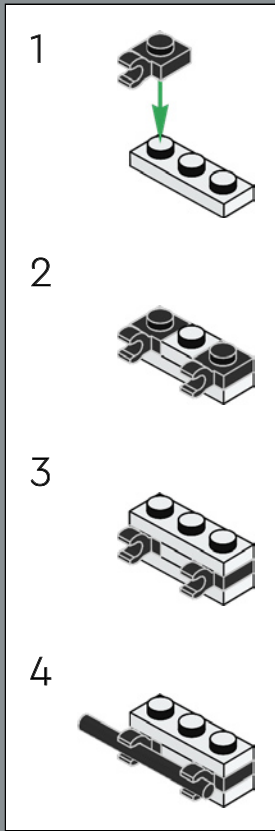

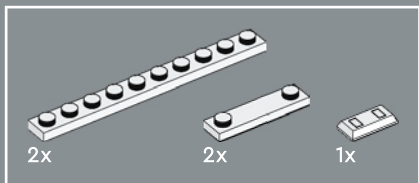

45

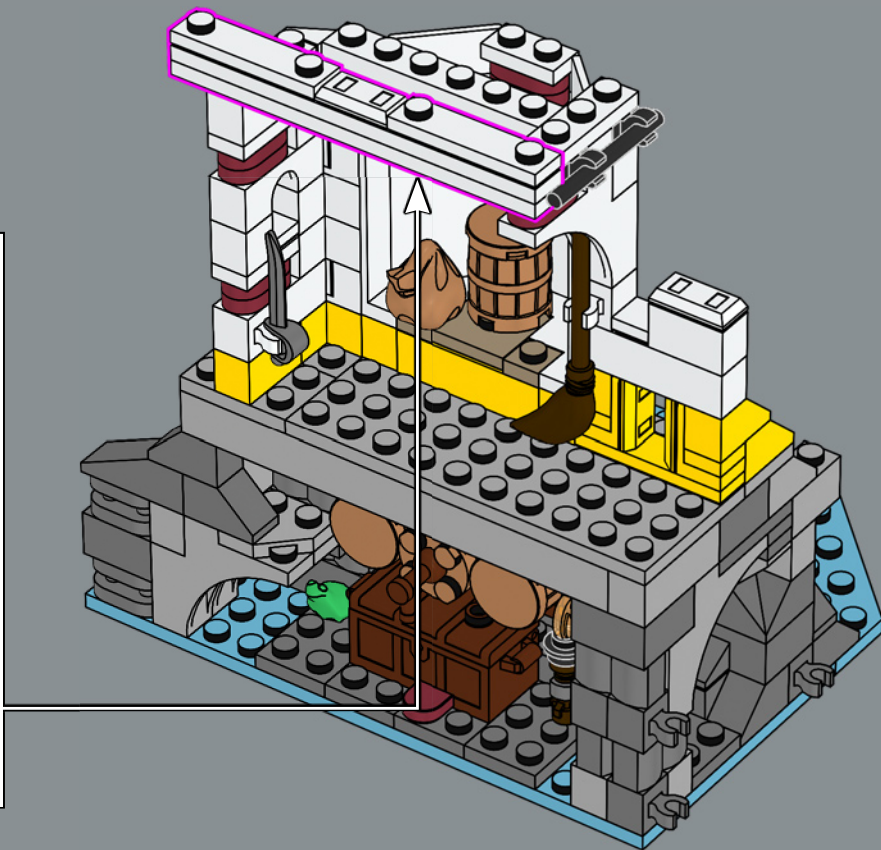
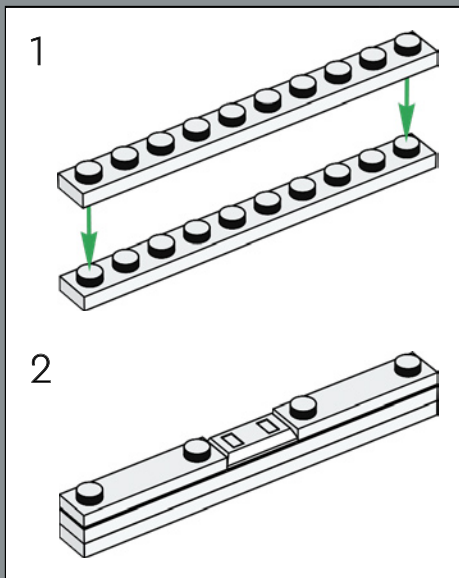

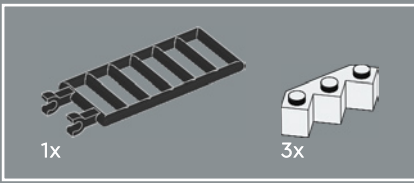

46

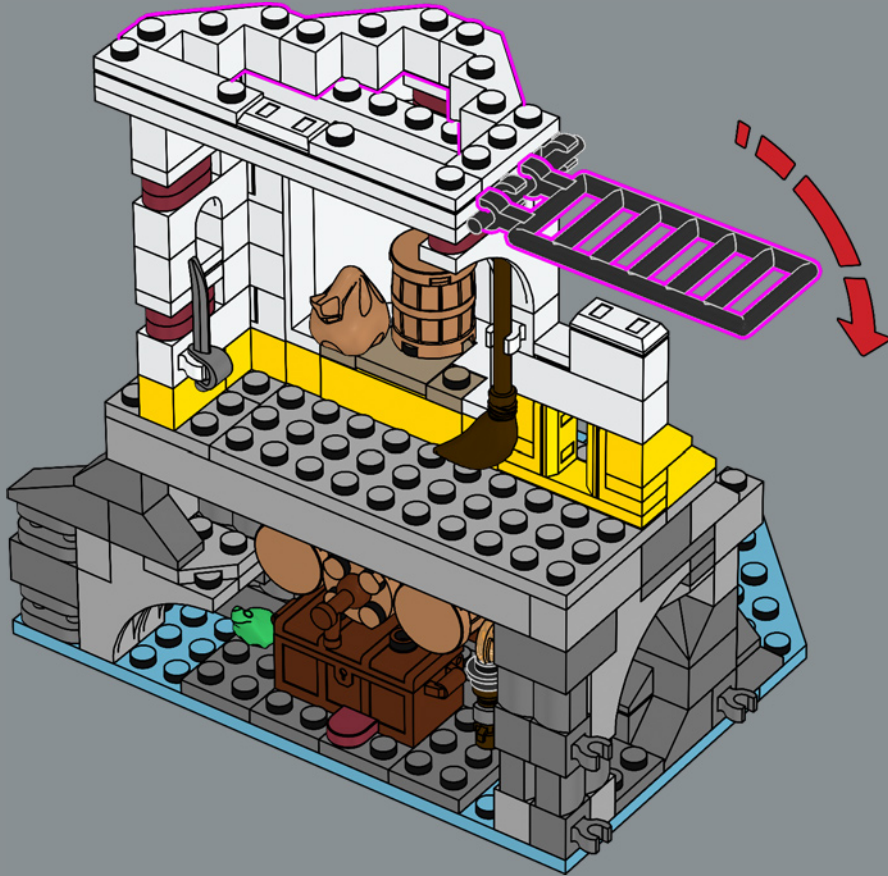

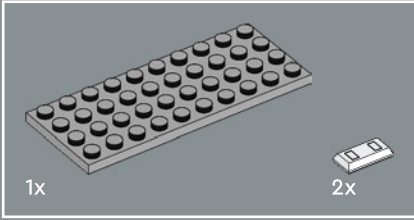
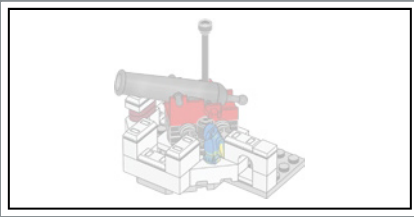

47

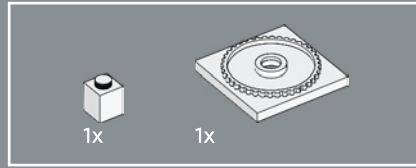
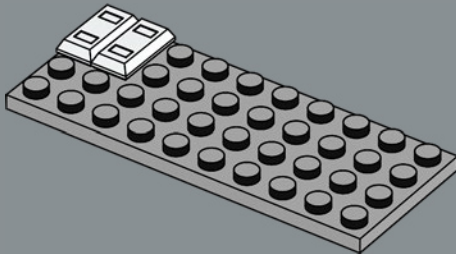

48

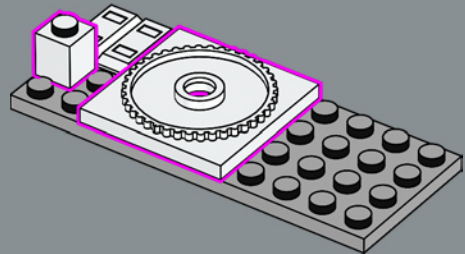



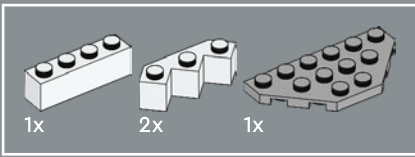

49

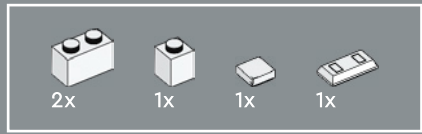
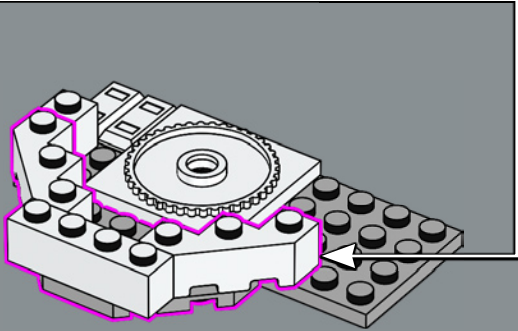
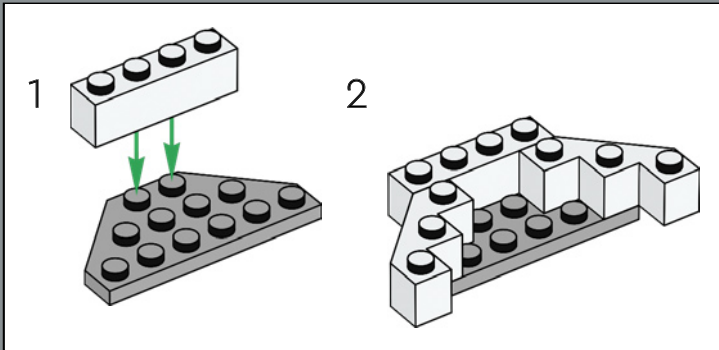

50

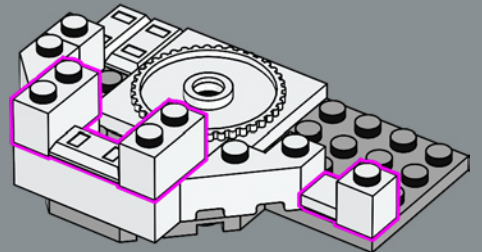

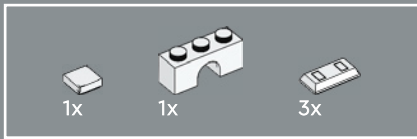

51

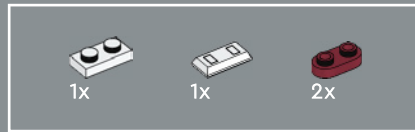
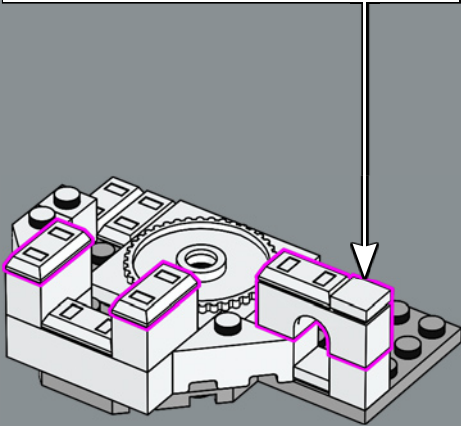
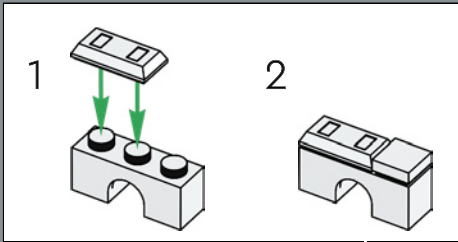

52

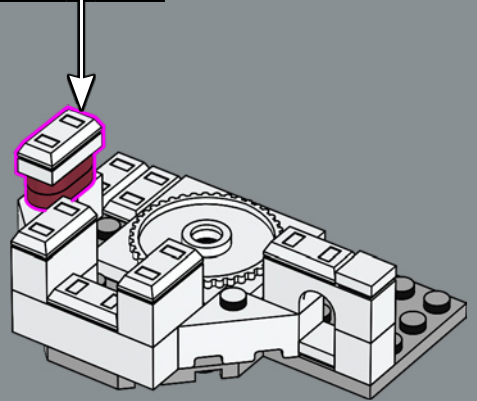
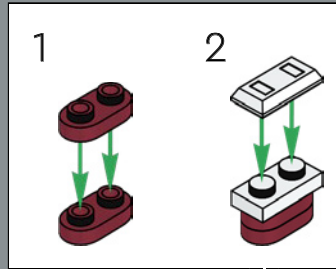

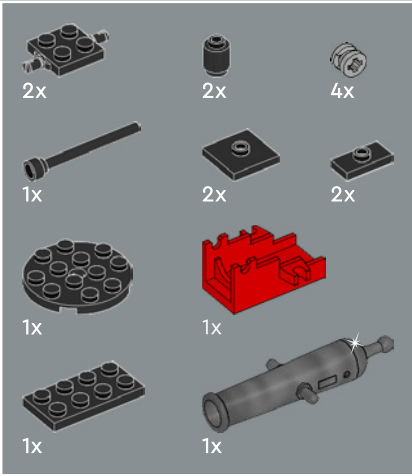
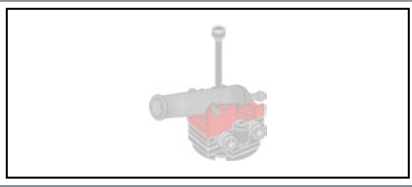

53

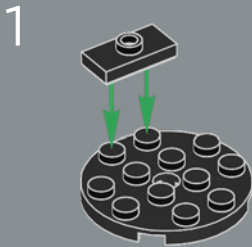

2

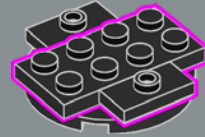

3

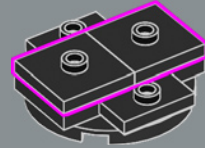

4

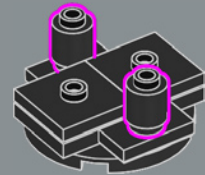



Need to attack pesky pirates from a different angle? You can move the cannons on the towers back and forth to turn or move them to other areas of the fortress.

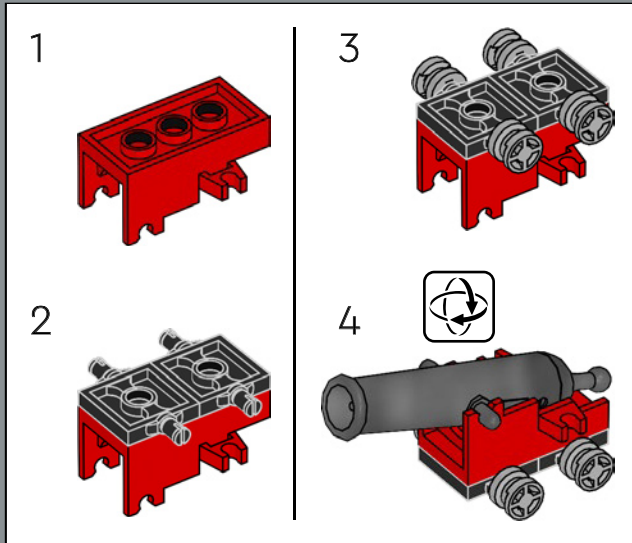

5

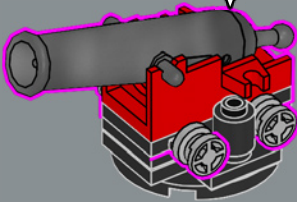

3

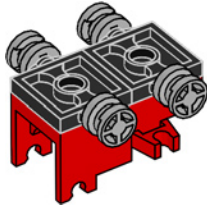

4

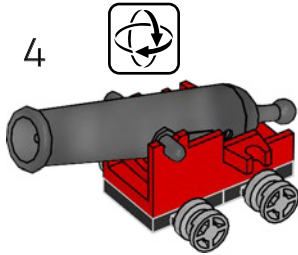

6

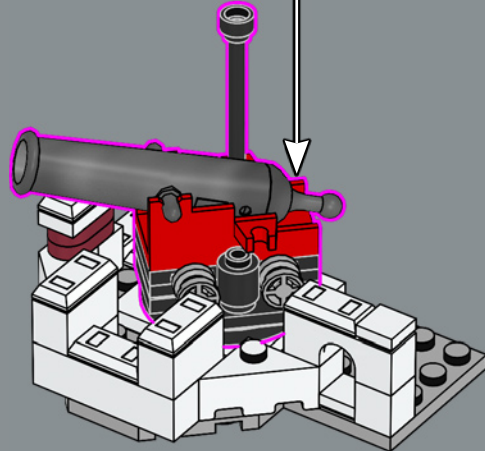
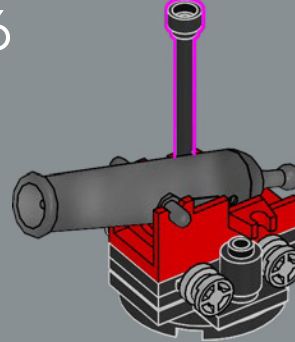

Vous avez besoin d'attaquer les pirates sous un angle différent ? Vous pouvez déplacer les canons des tours d'avant en arrière pour les faire tourner ou les déplacer vers d'autres zones de la forteresse.

¿Tienes que atacar a los latosos piratas desde otro ángulo? Puedes mover los cañones de las torres hacia atrás y hacia adelante para girar, o llevarlos a otras zonas de la fortaleza.



54

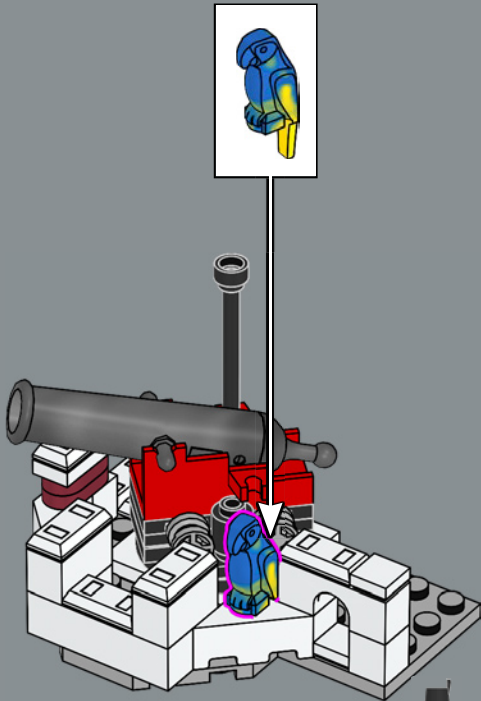

55

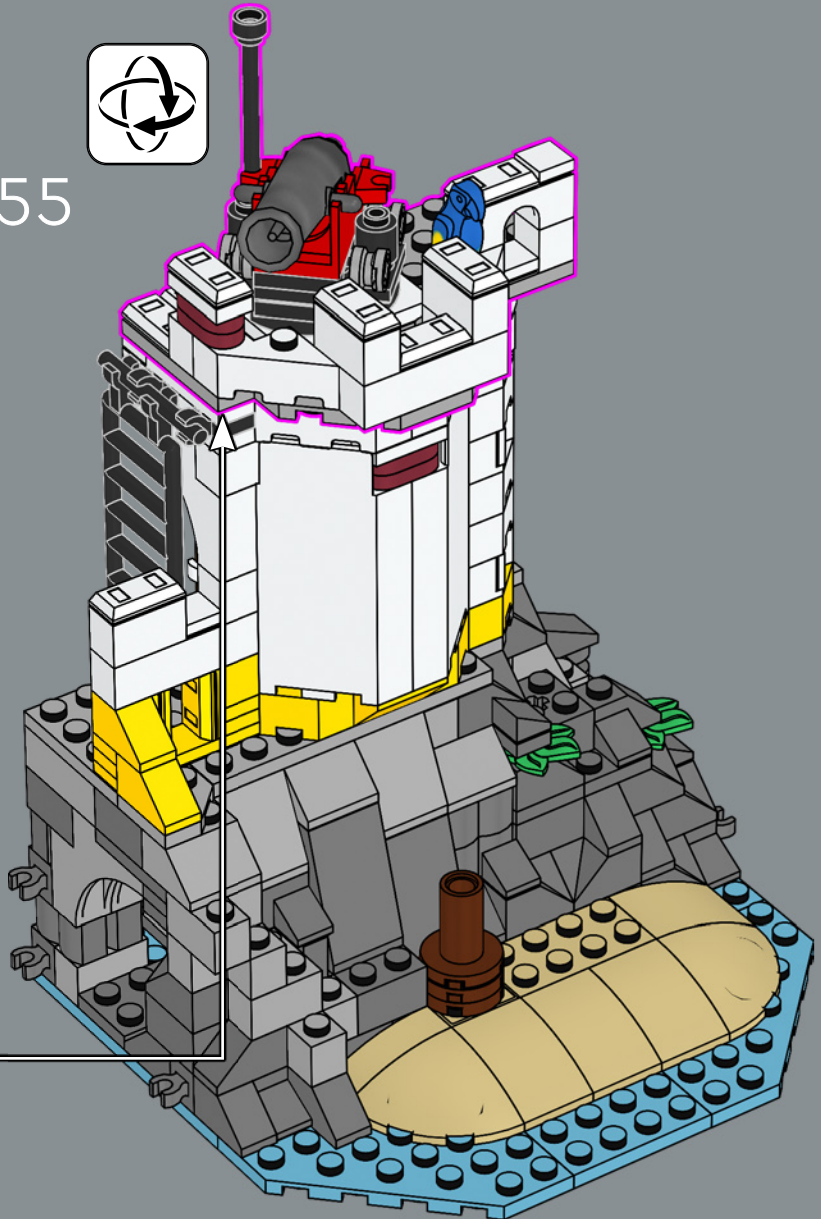



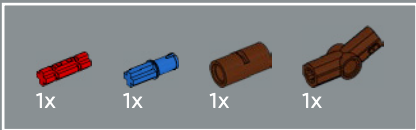

56

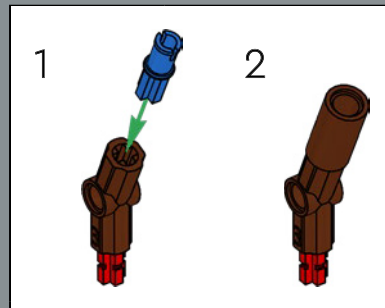
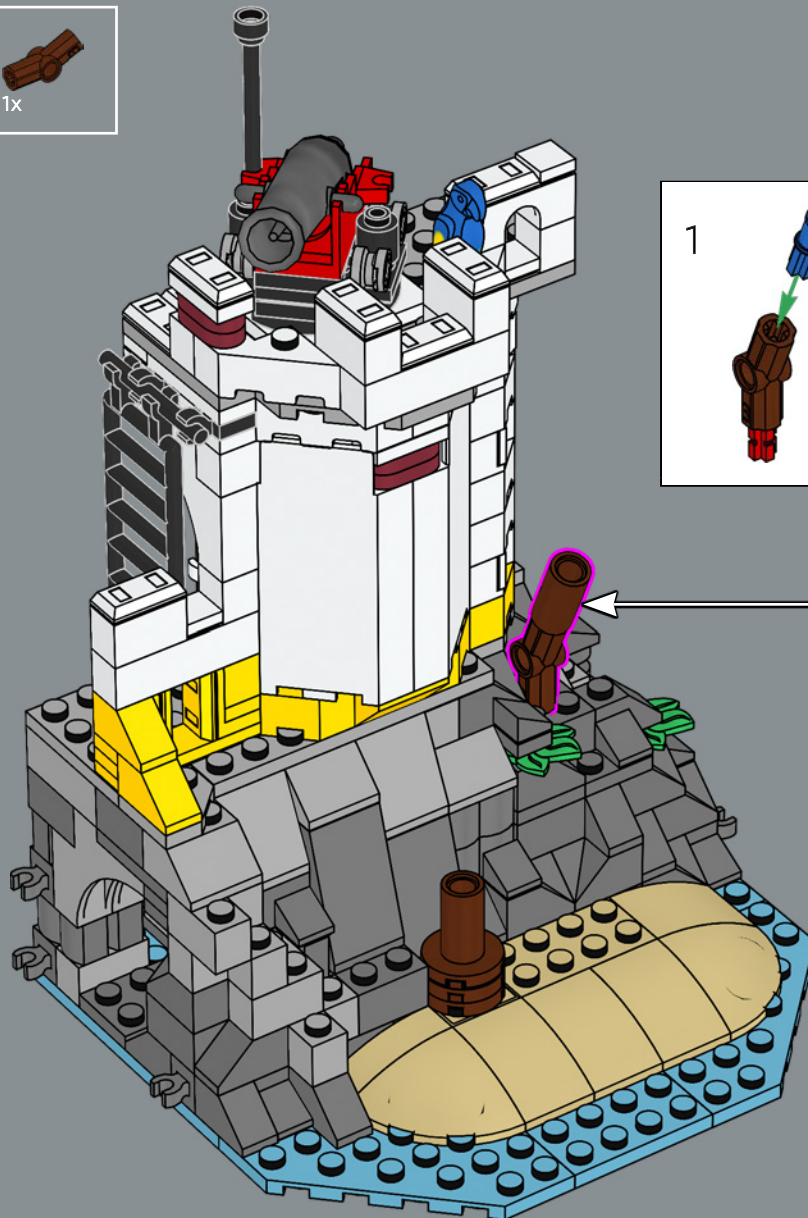

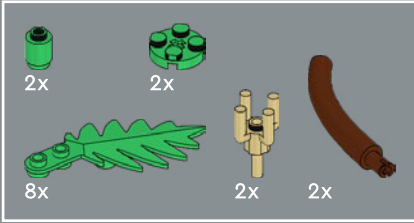
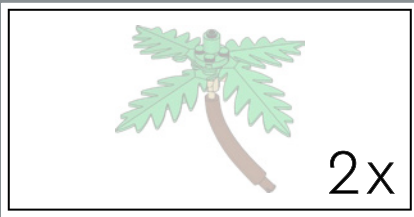

57

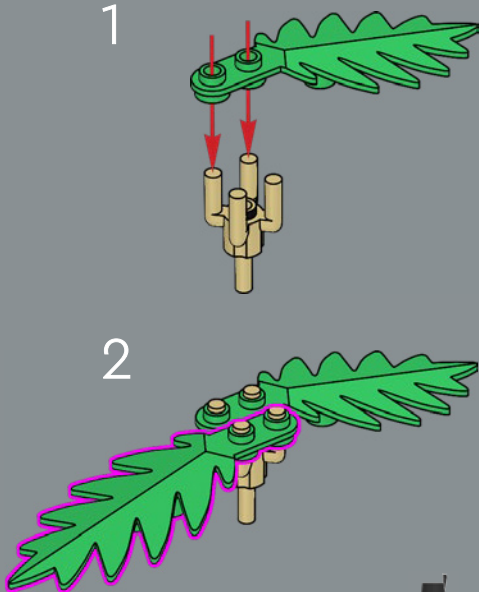

3



4

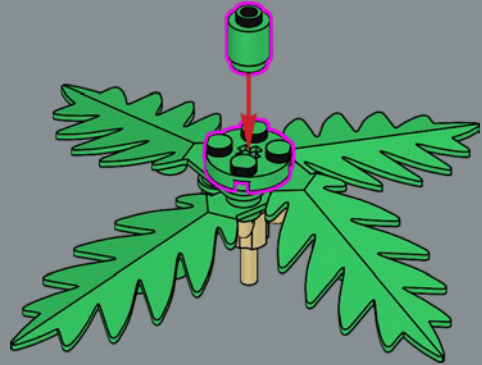

5



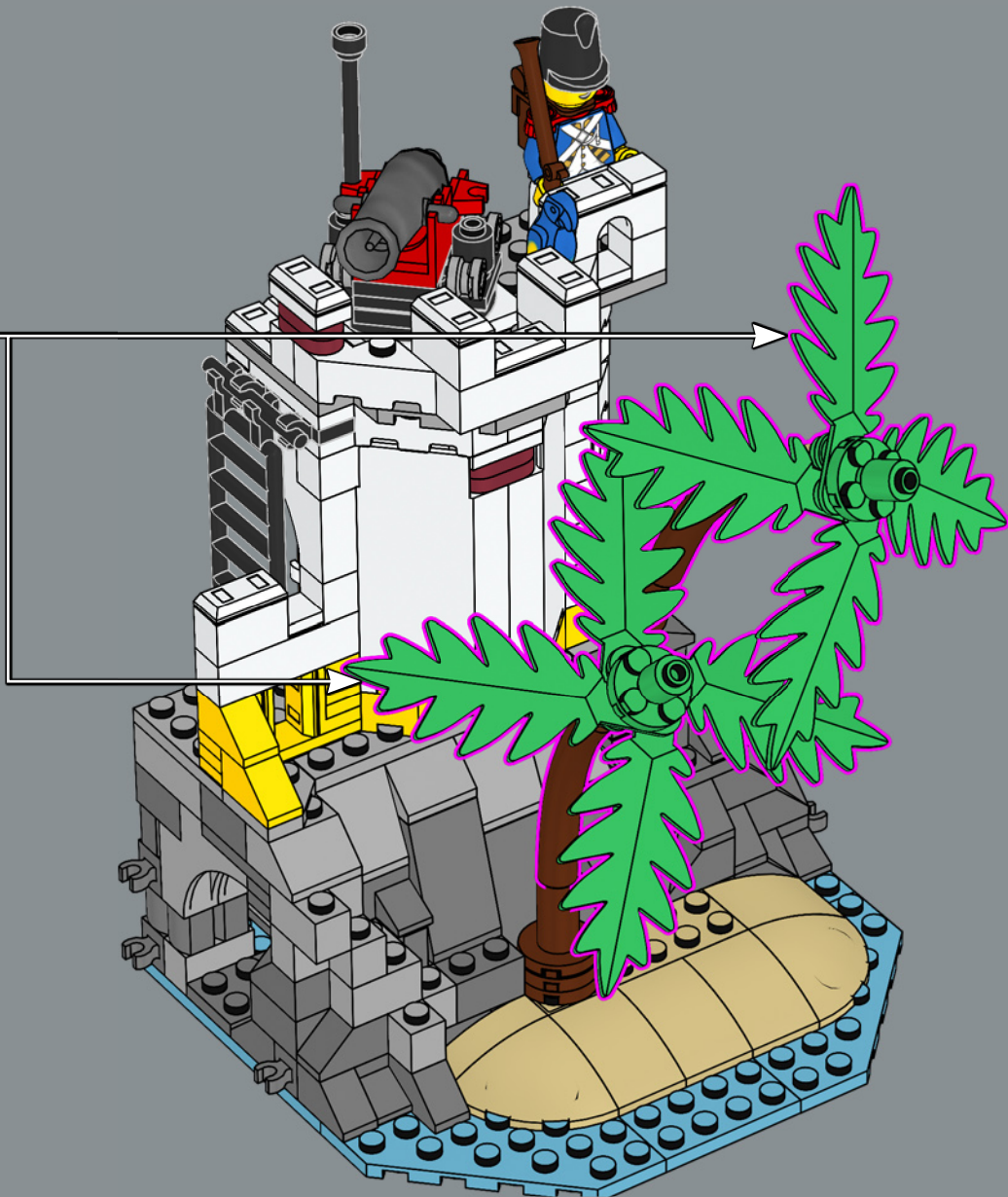

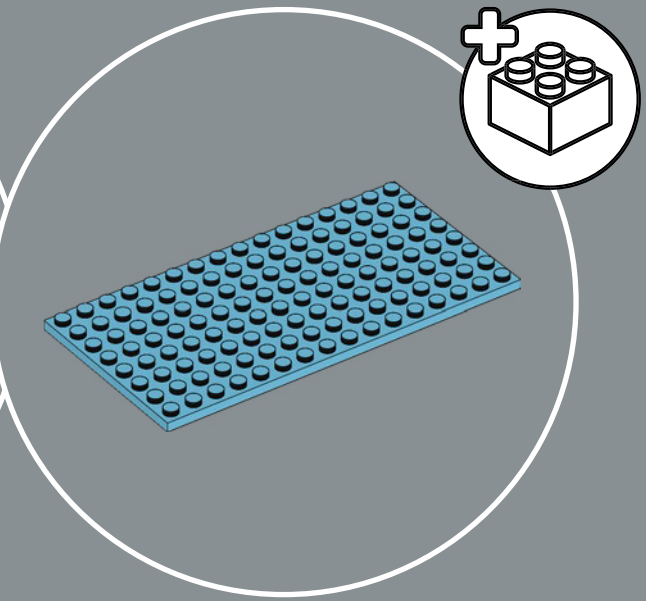

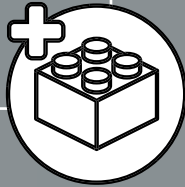
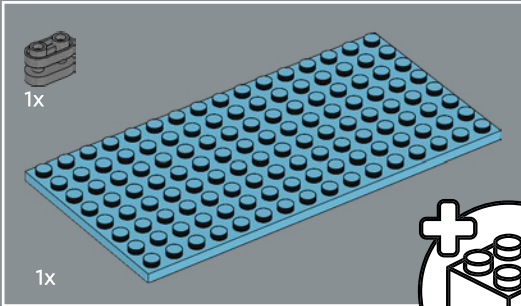
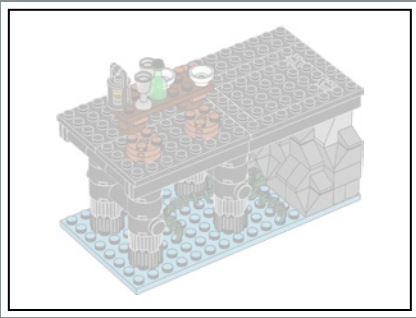

58

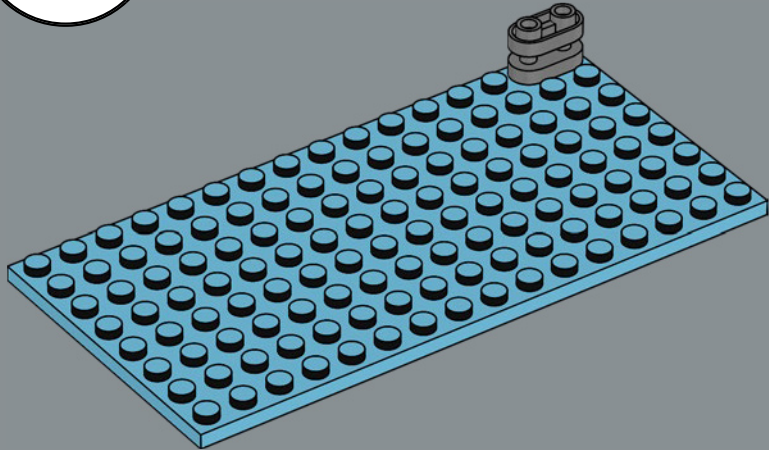



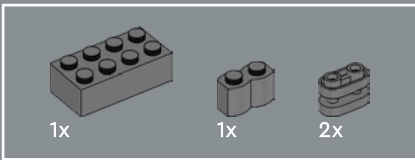

59

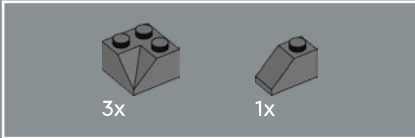
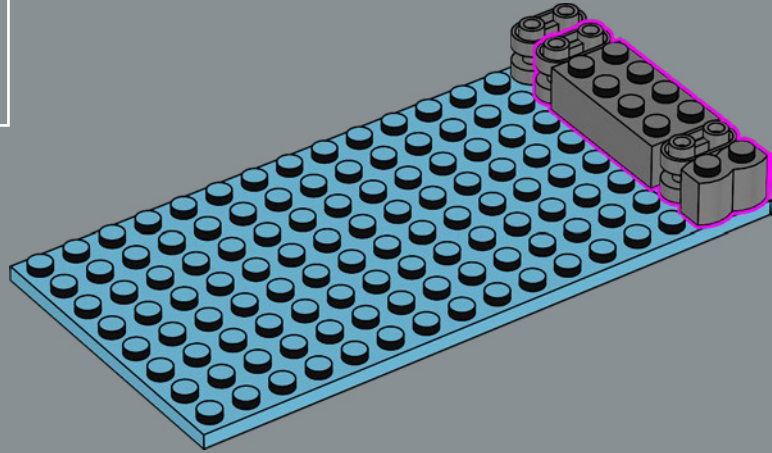

60

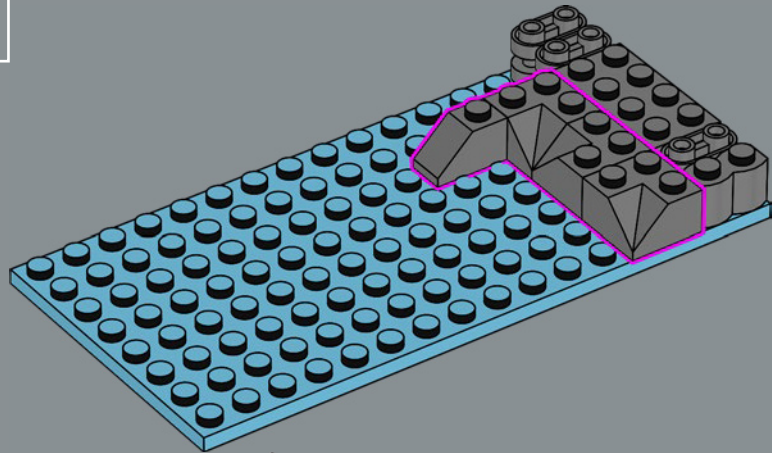



61

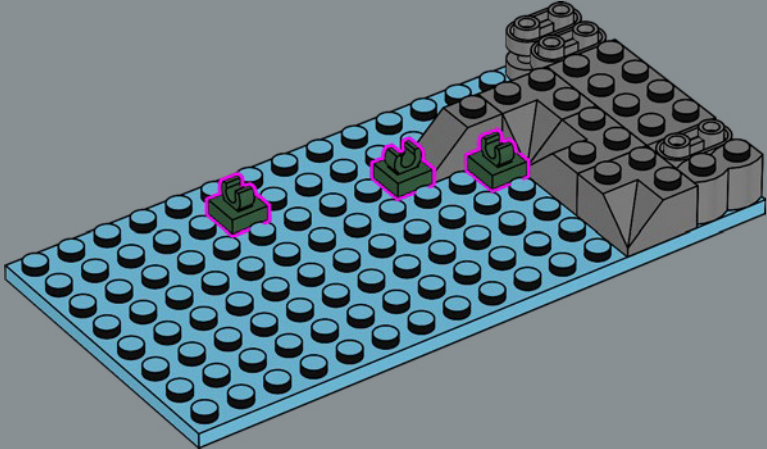

62

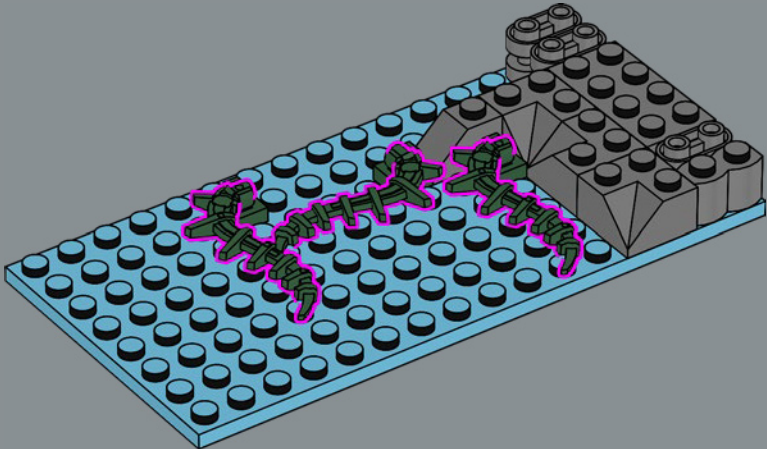

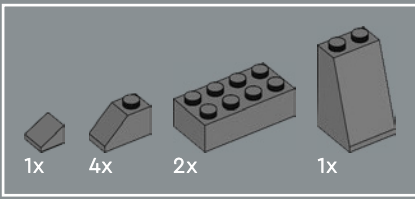

63

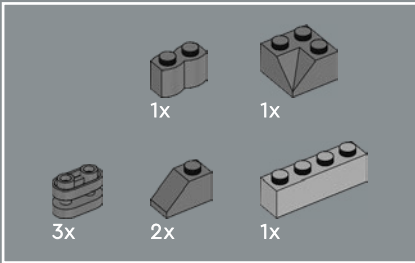
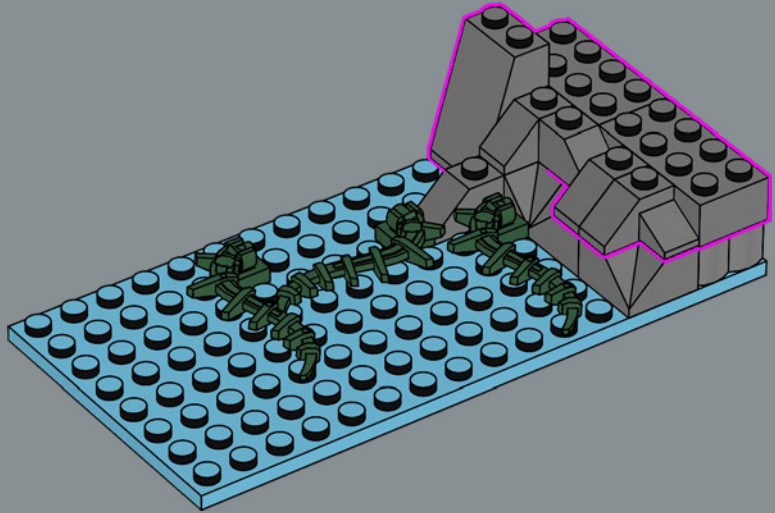

64

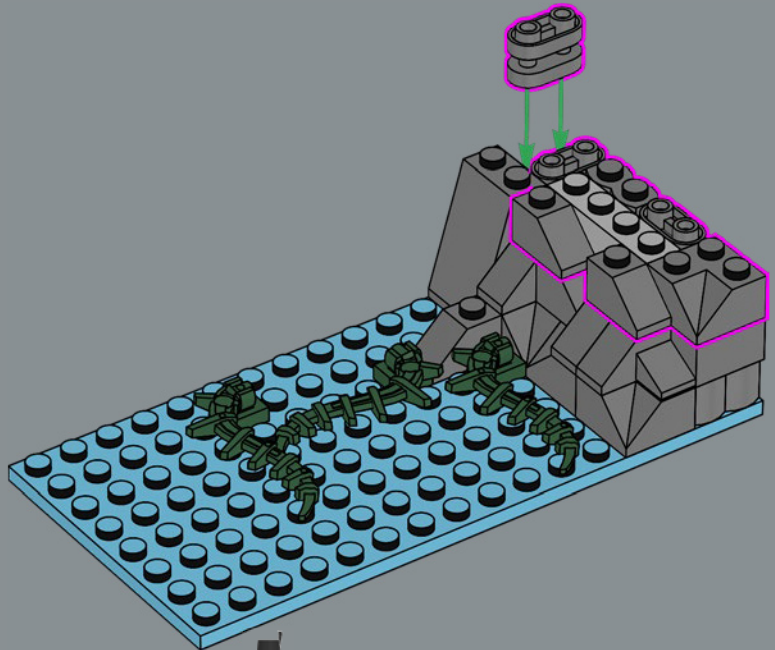

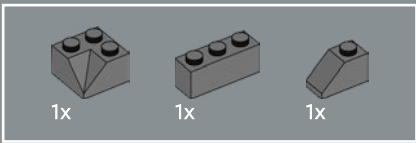

65

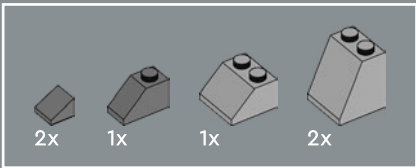
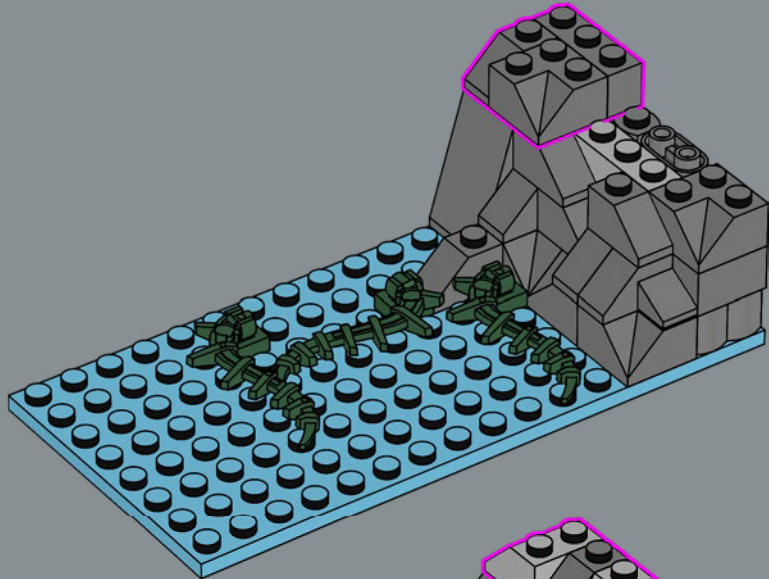

66

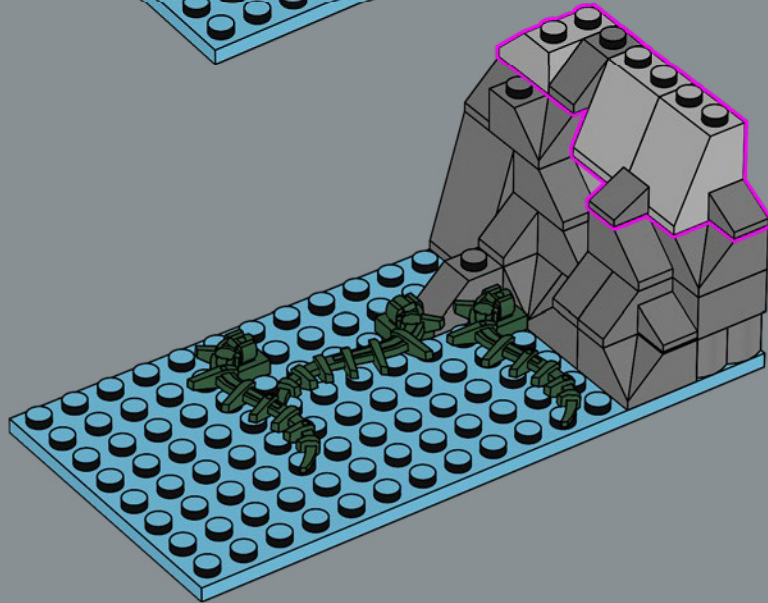

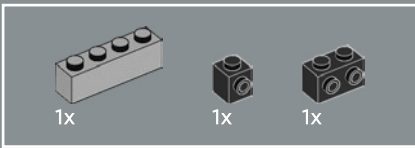

67

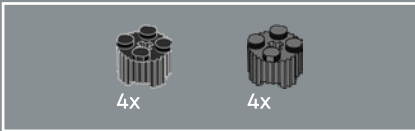
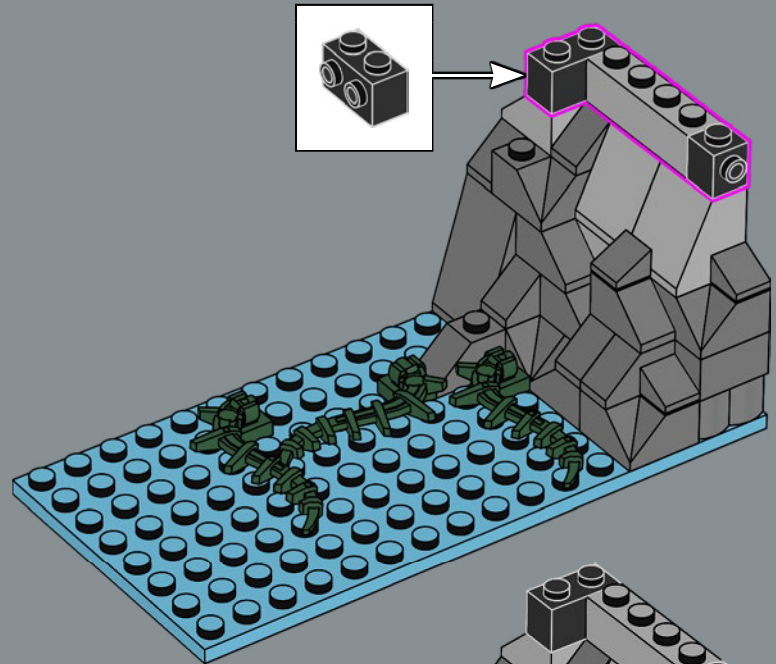

68

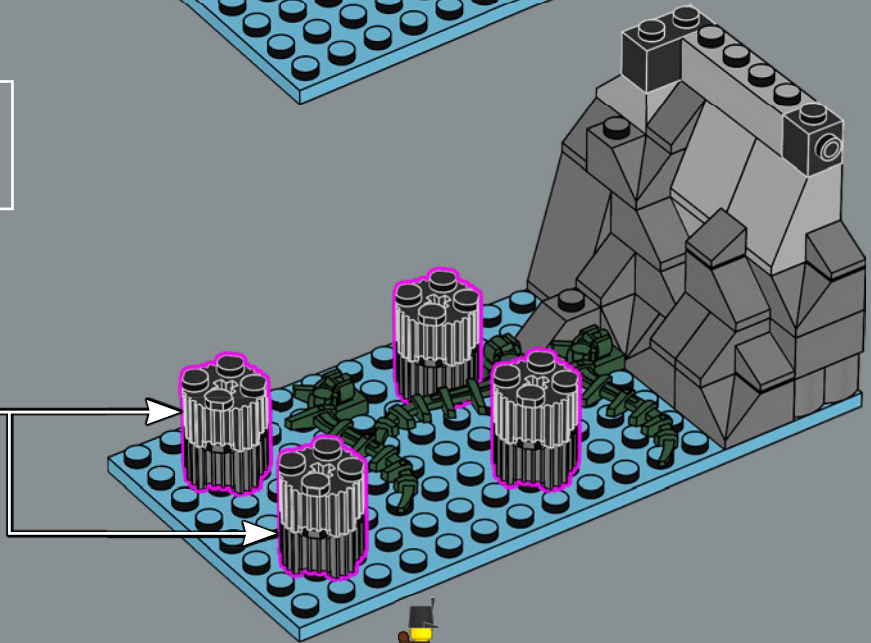
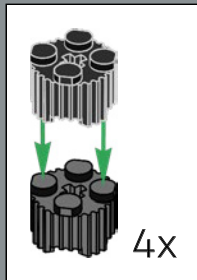



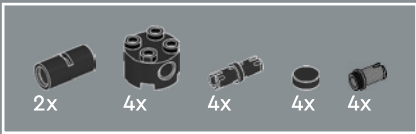

69

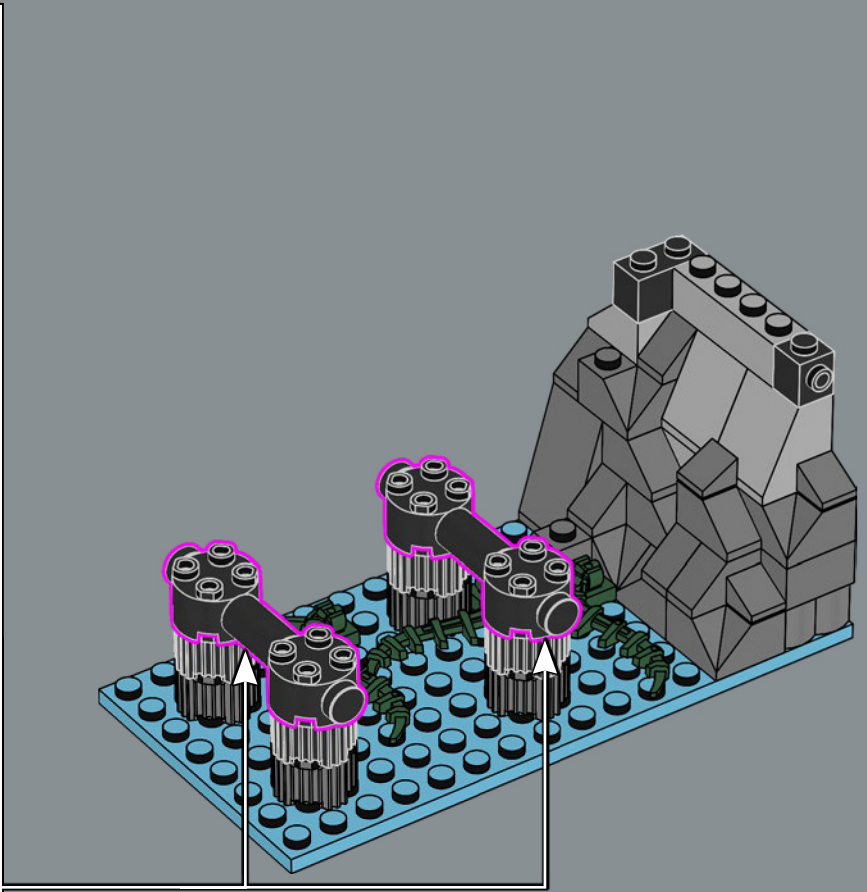
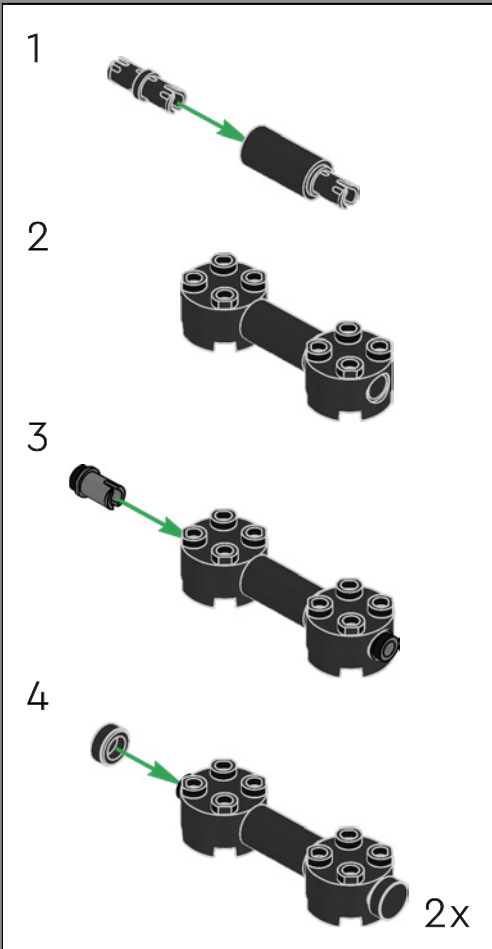

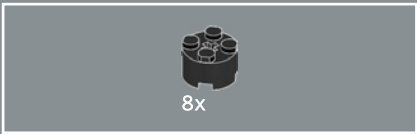

70

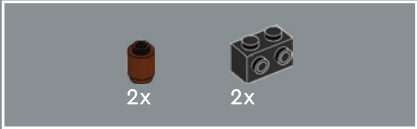
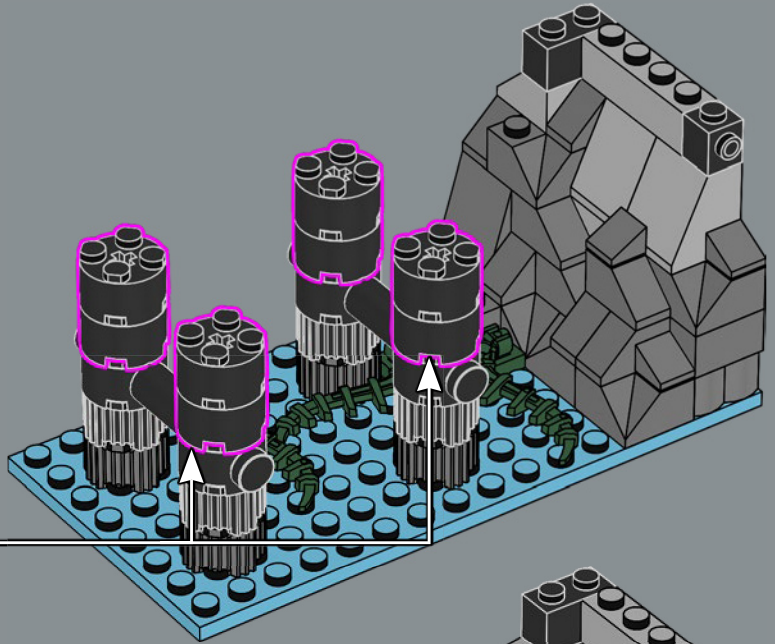
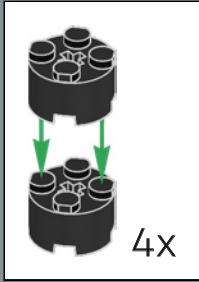

71

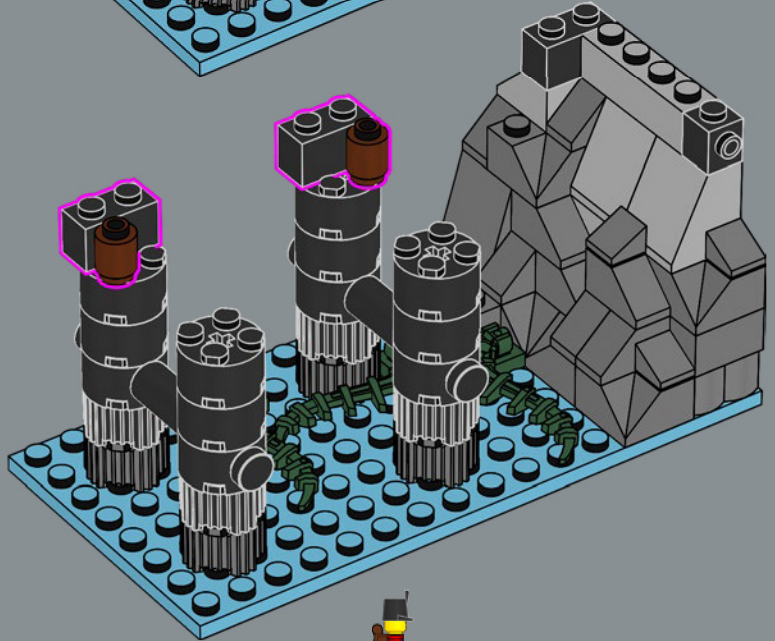

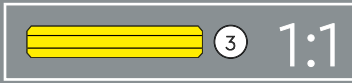
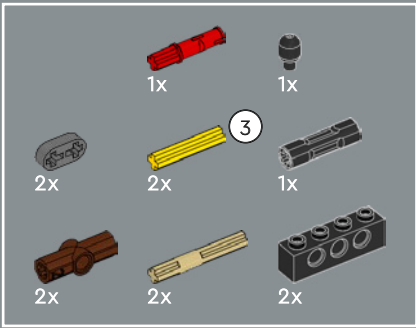

72

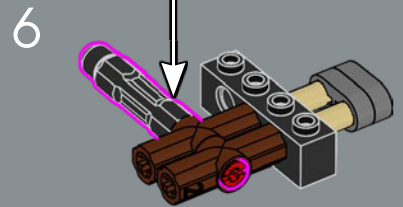
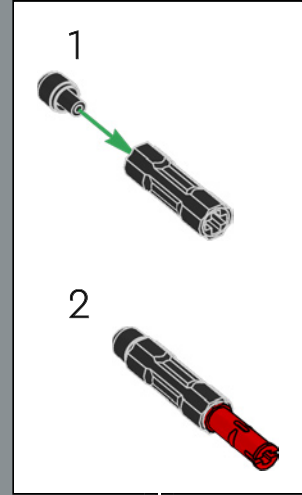
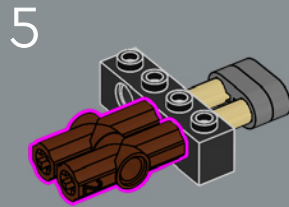
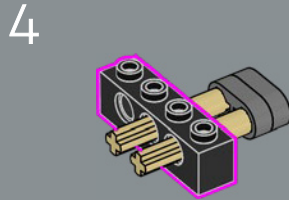
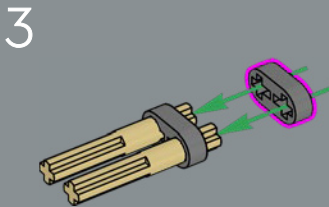
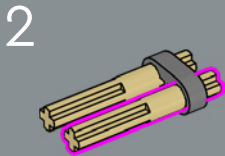
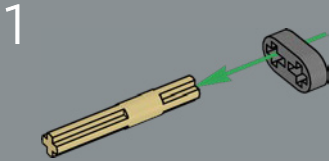

7

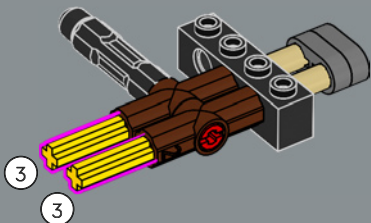

8

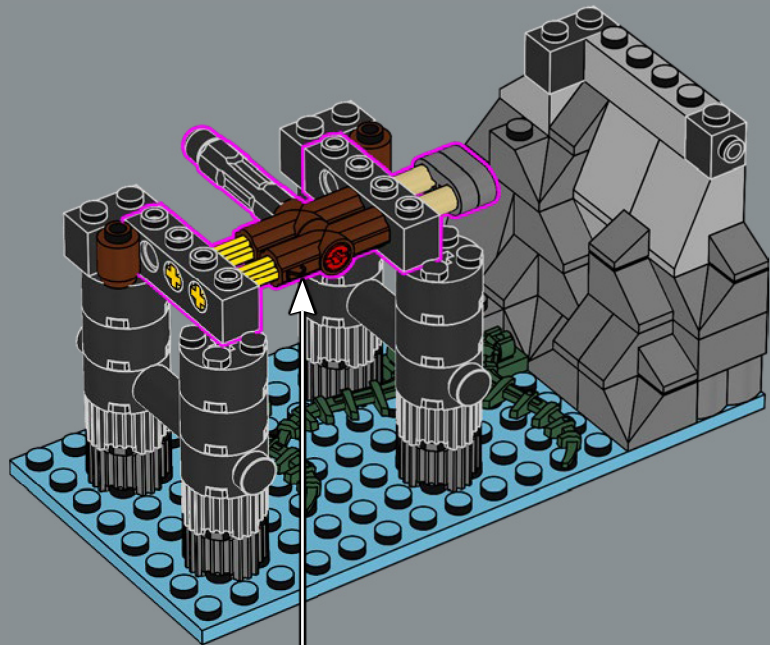
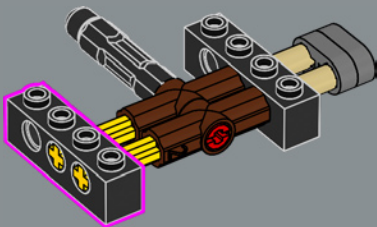



2x

73

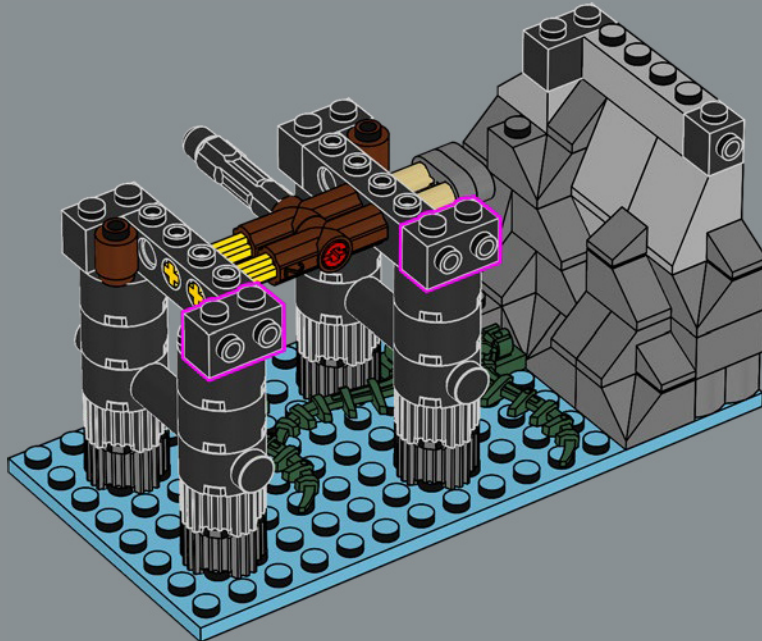



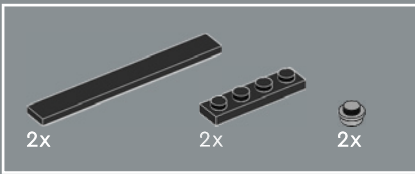

74

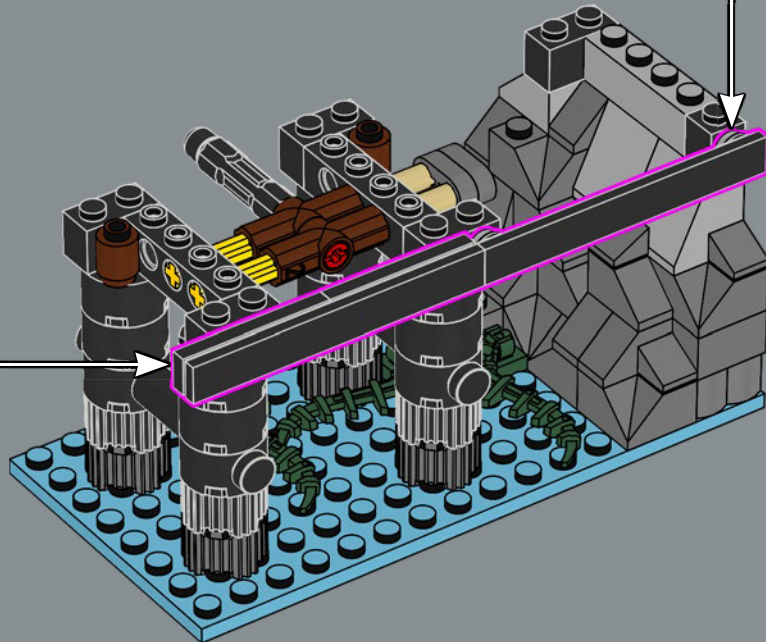
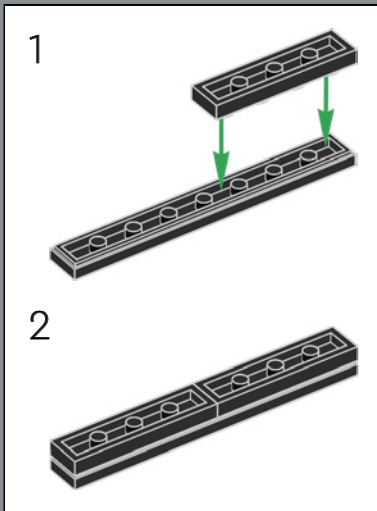
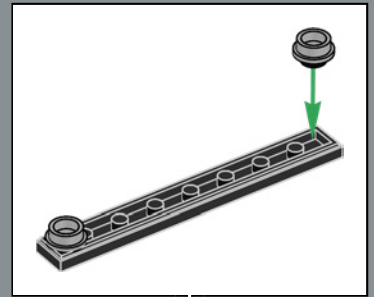

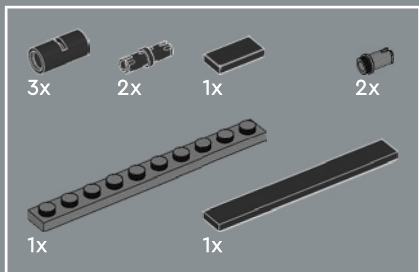

75

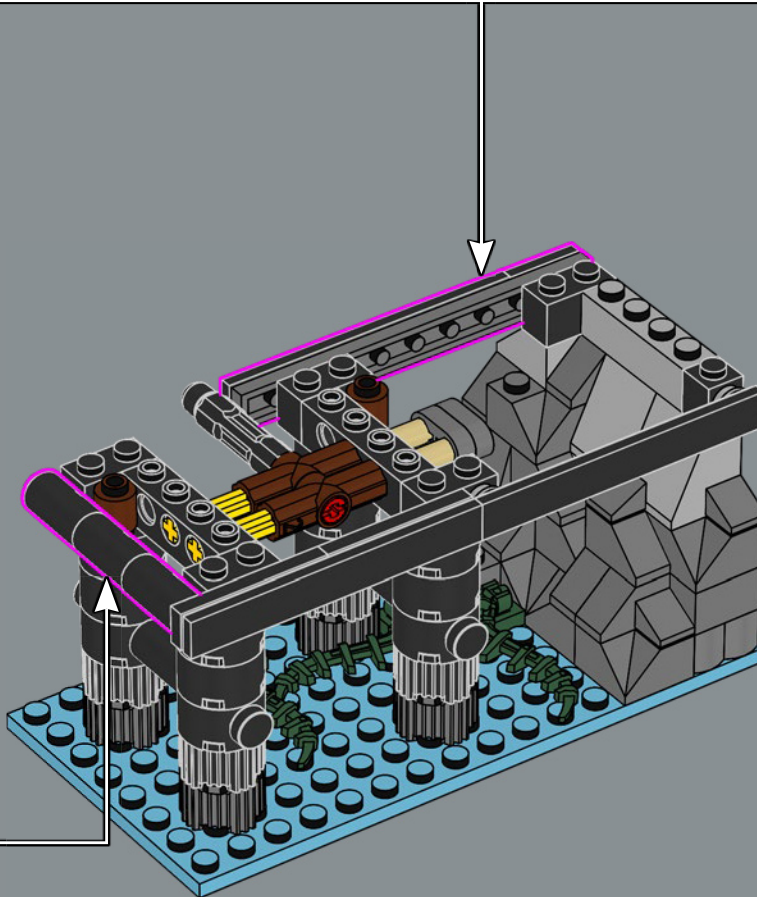
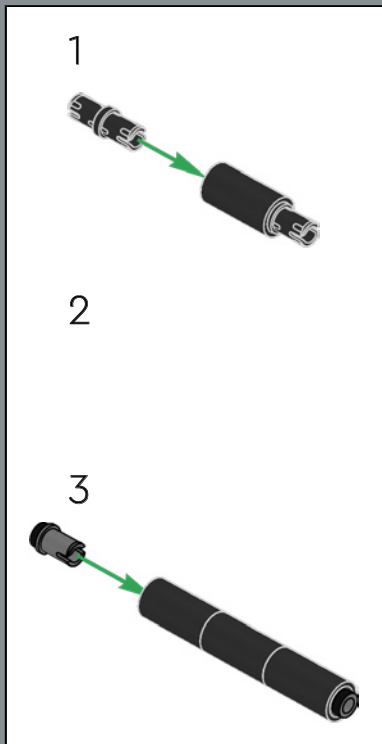
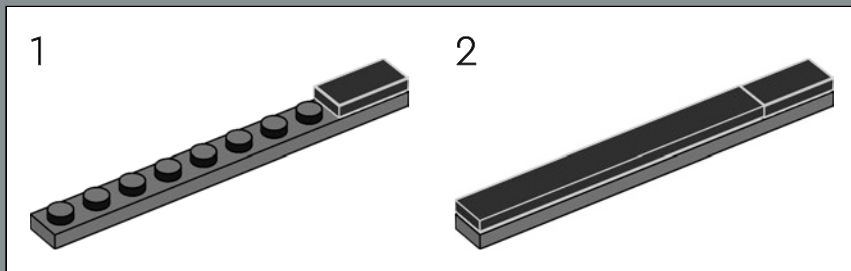

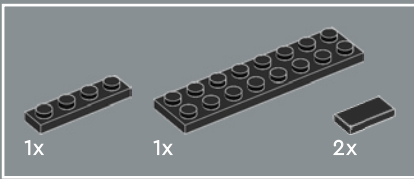

76

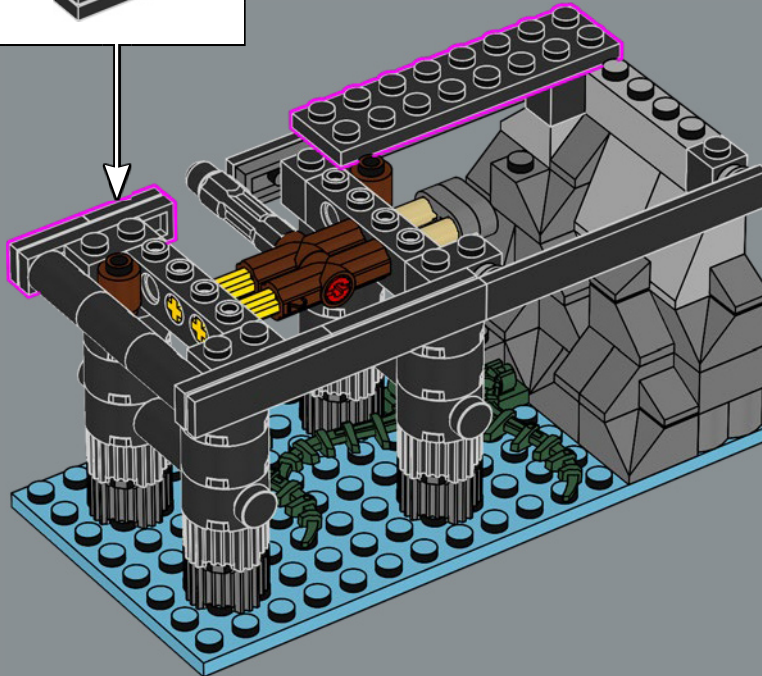
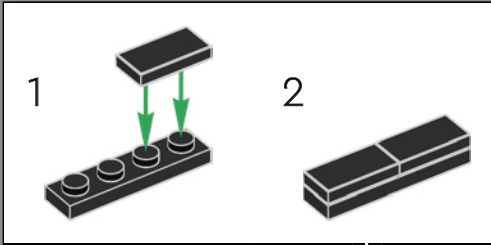

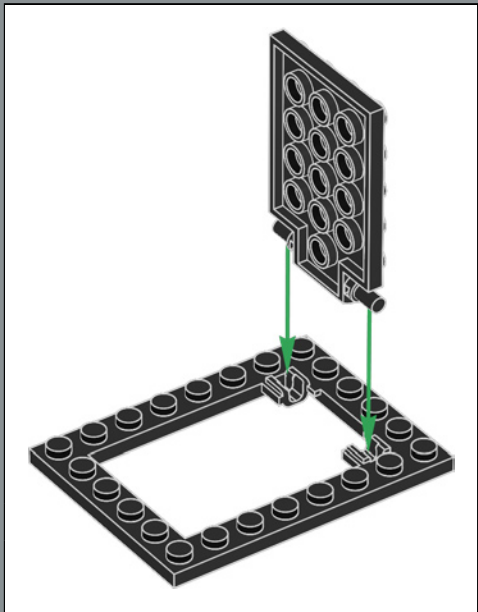
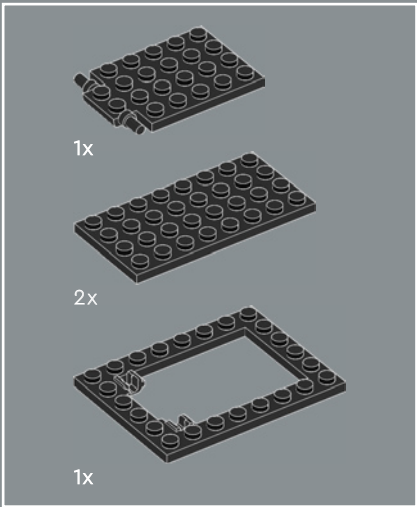

77

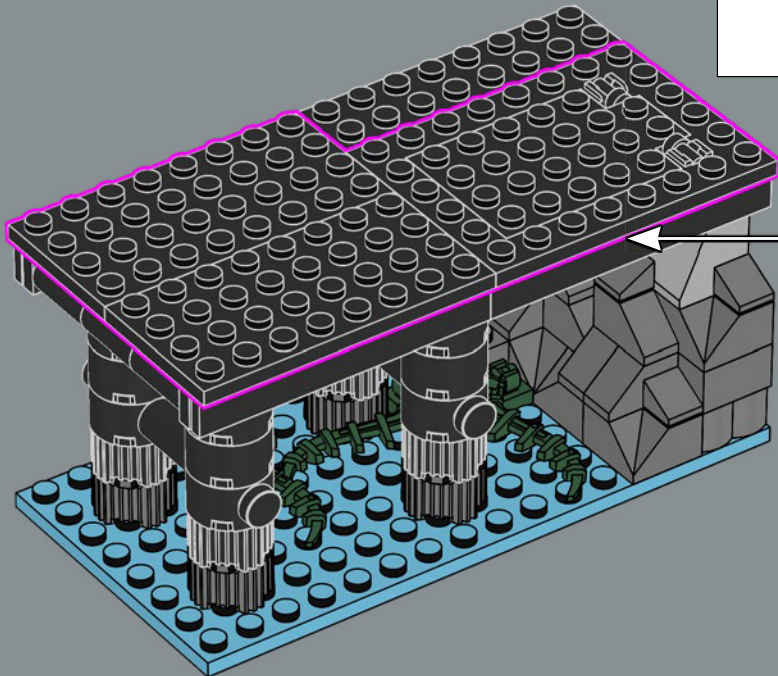

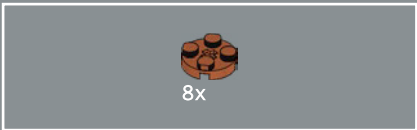

78

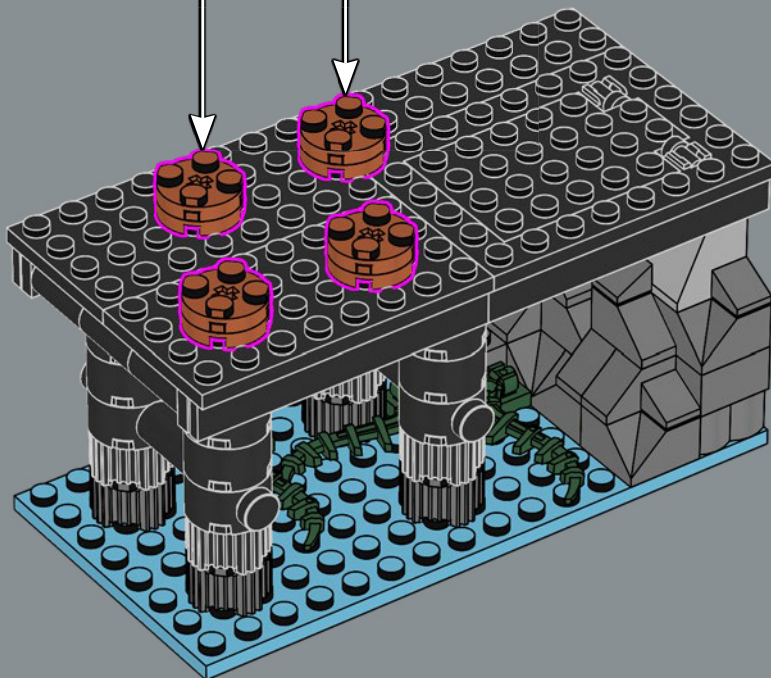
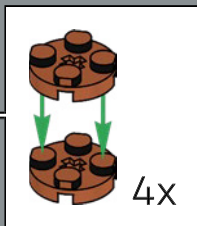



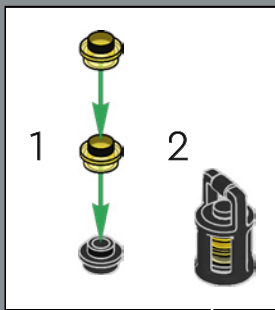

79

1

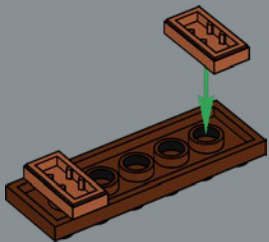

2

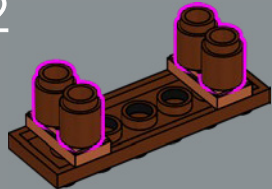

3

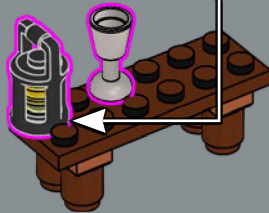

4



5

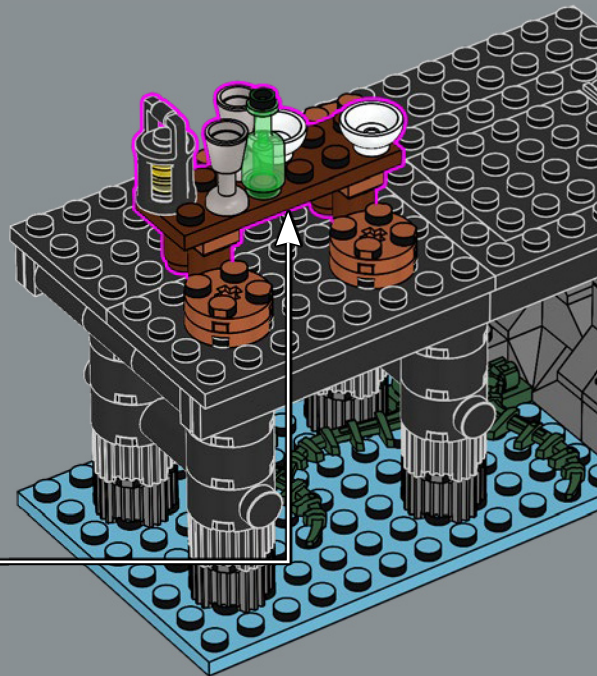



If you already have the LEGO® Ideas 21322 Pirates of Barracuda Bay set, you can dock it alongside the pier.

Si vous possédez l'ensemble LEGO® Ideas 21322 Les pirates de la baie de Barracuda, vous pouvez l'amarrer le long de la jetée.

Si tienes el set LEGO® Ideas Piratas de Bahía Barracuda (21322), puedes atracarlo en el muelle.

